

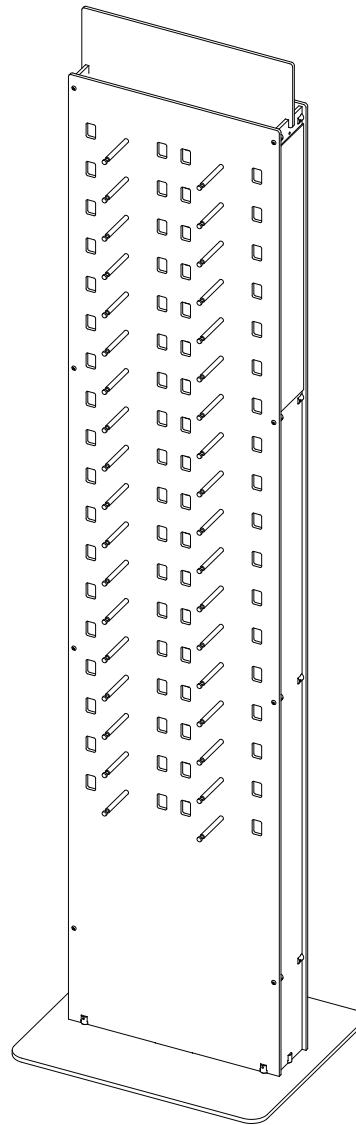

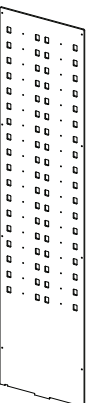

PPIN-4-72



A  2	B  2	C  1	D  Optional	E  22	F  72
		G  1	H  6	I  22	

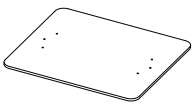
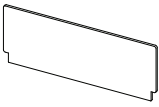
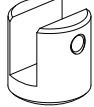
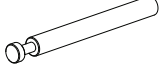

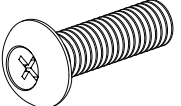
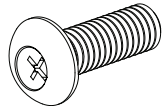
Step 1

72

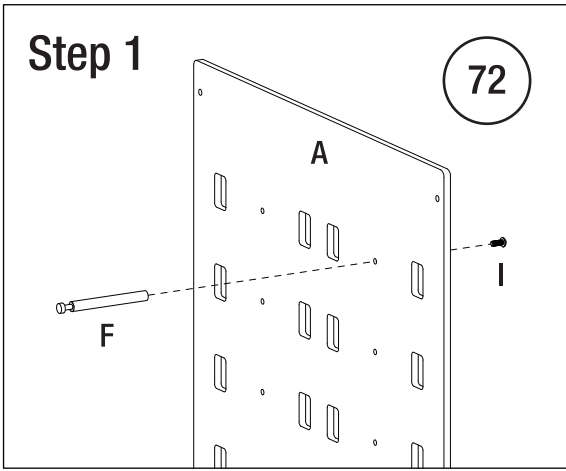

Step 2

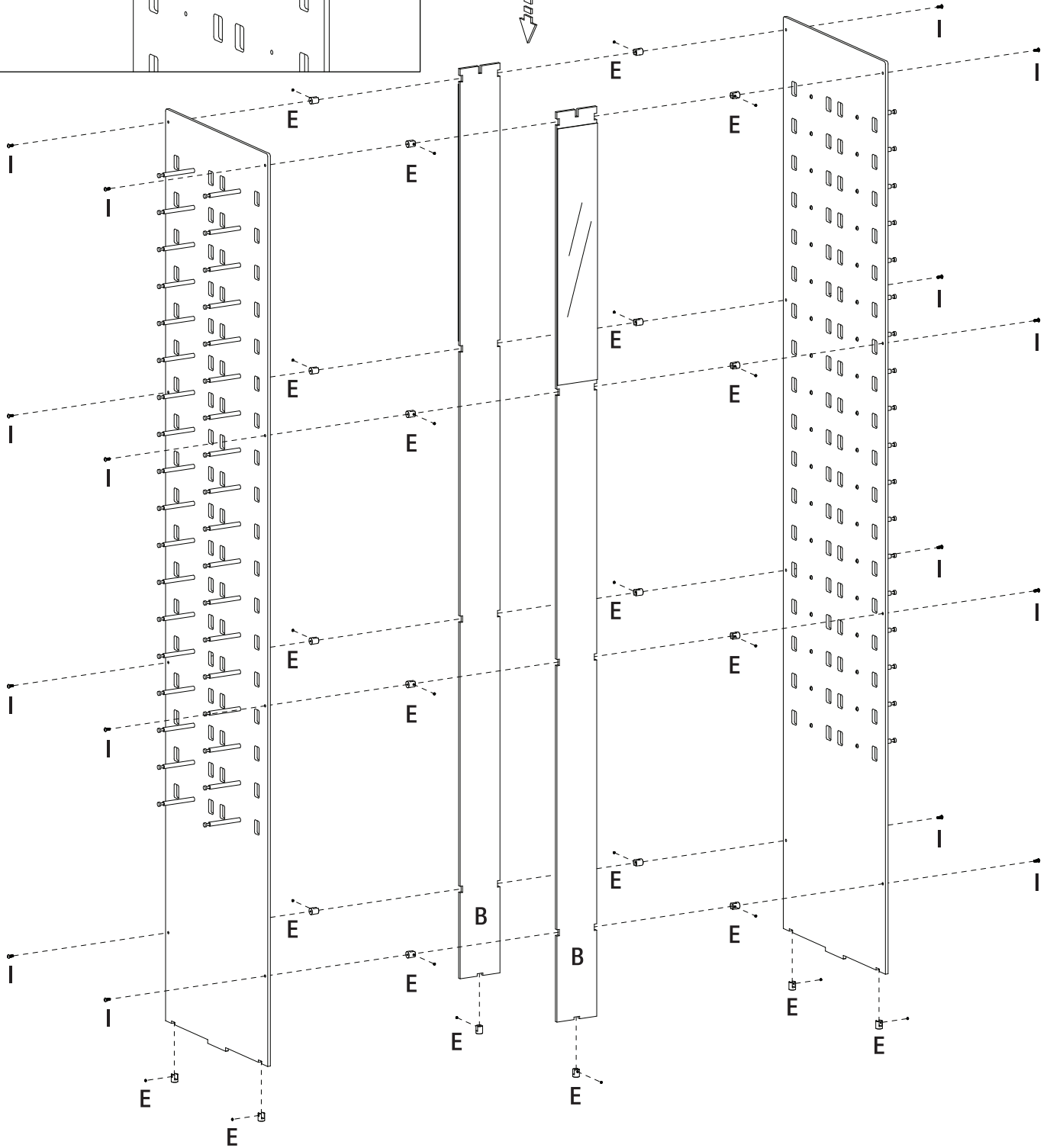
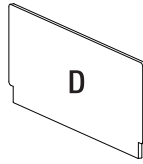

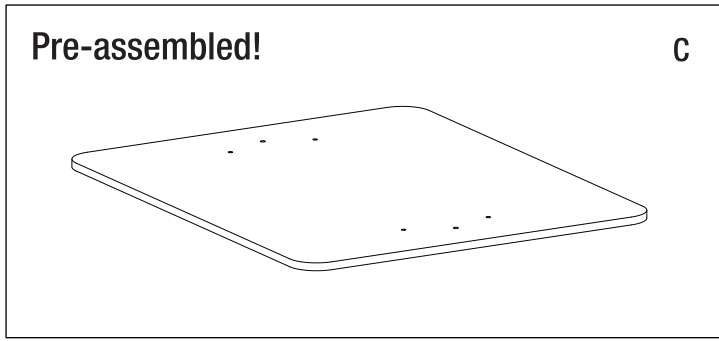

Step 3

