

Hanging Clear Cubes

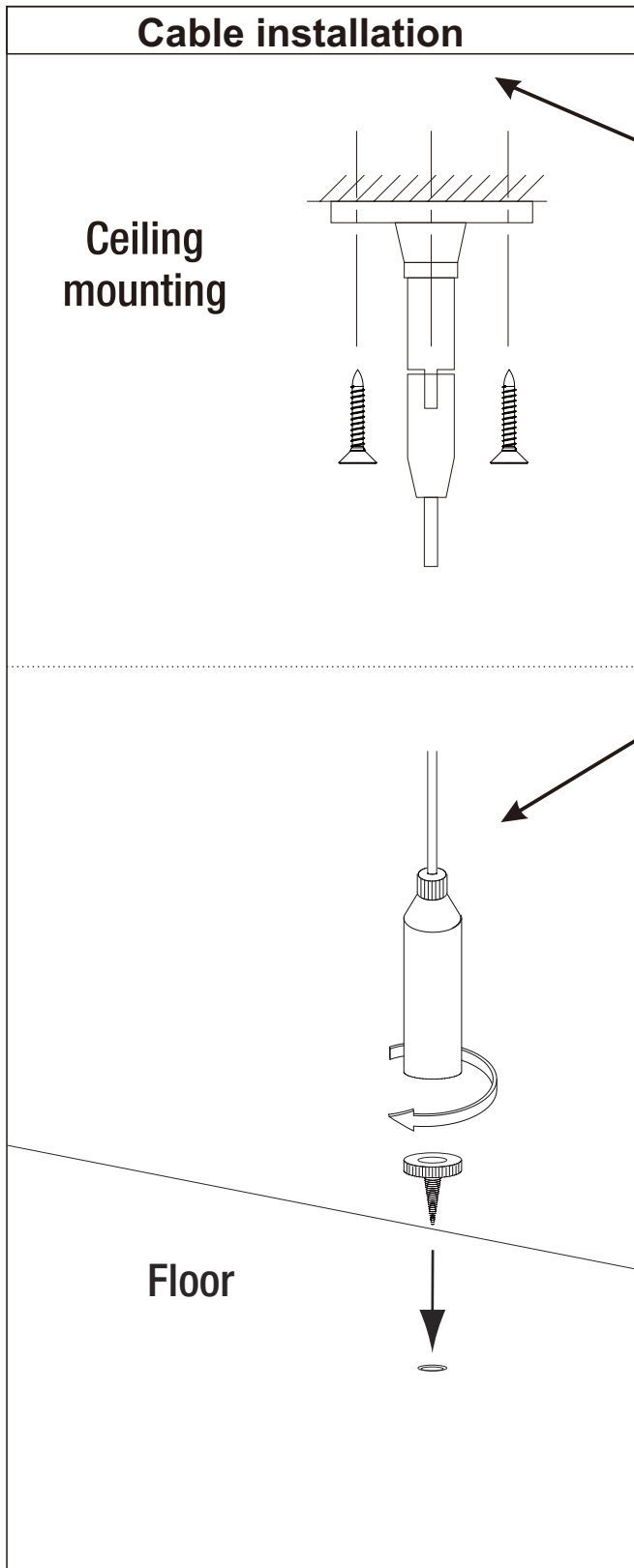

*Never tighten screws with an electric tool.

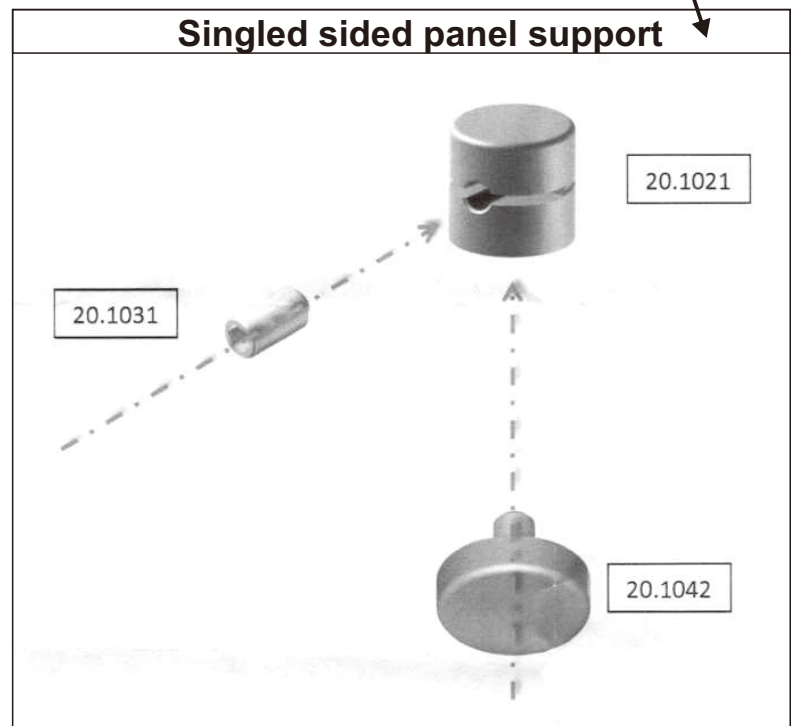
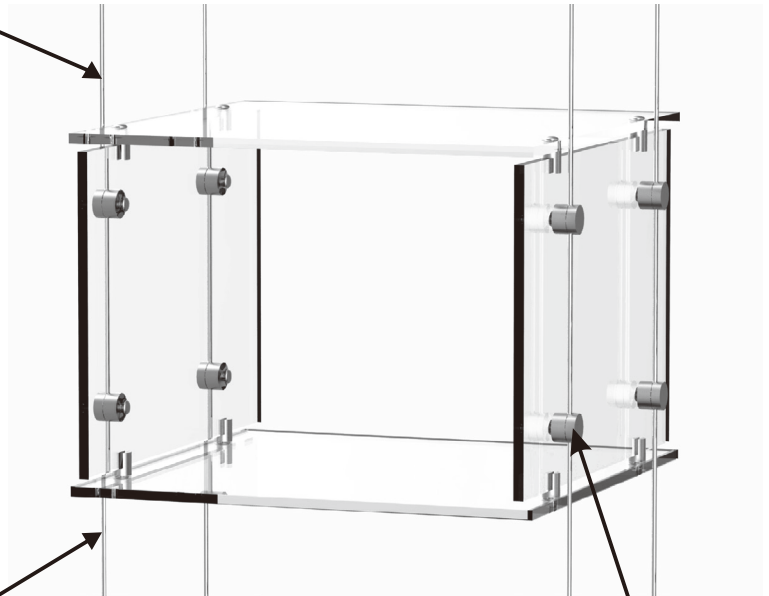

Locking (6 sided)

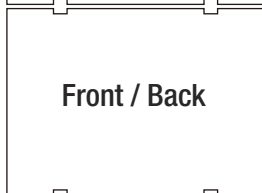
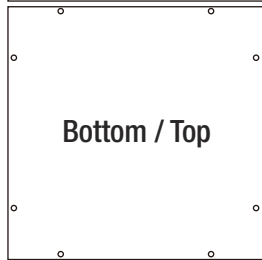
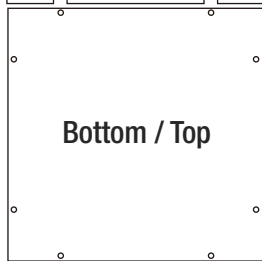
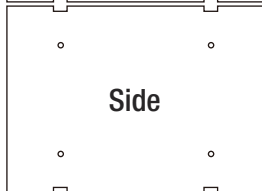
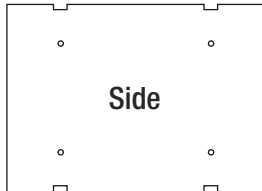

Open (4 sided)

