

STANDARD ACRYLIC WALL SHELVING SYSTEM

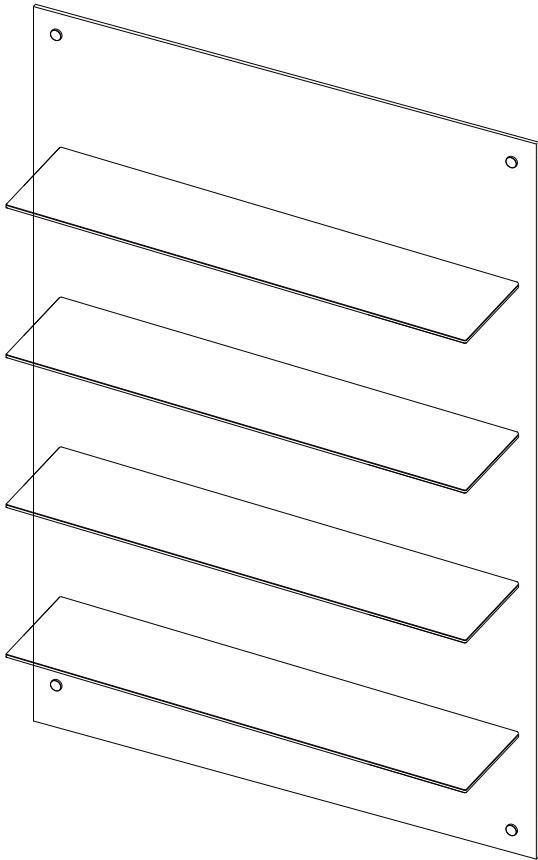

A Back Panel x 1

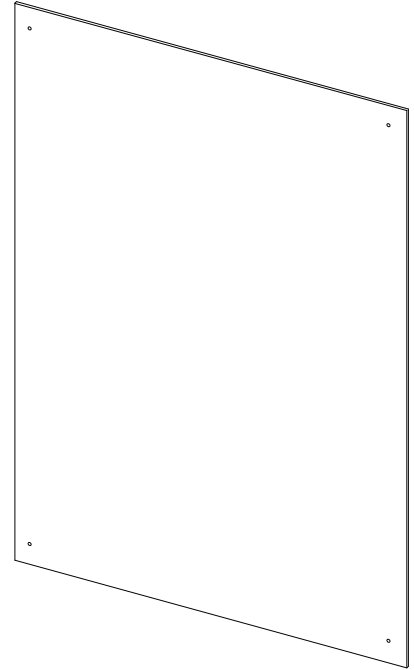

B Shelf

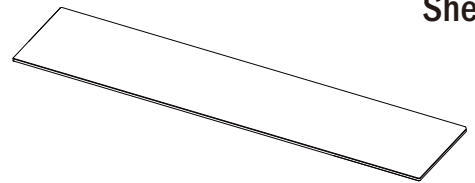

Quantity (Based on your order)

C 1" standoff (#13.15.20.25)

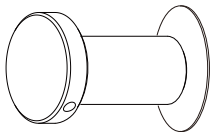

4 to 8 (Based on your order)

D Butterfly Anchors + Screws

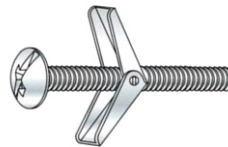

equal number to standoffs

E



Quantity (Based on your order)

F x 1

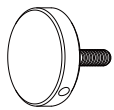

Standoff Cap
13.15.20.25-CAP

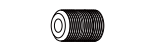

Upper Inside Threaded Barrel
13.15.20.25-BAR

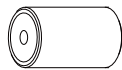

Standoff Cylinder
13.15.20.25-CYL



Standoff Screw
13.15.20.25-SCR



Lower Inside Threaded Barrel
13.15.20.25-BAR



Standoff Washer
13.15.20.25-WSH



Toggle Bolt

Place the back panel on the wall and mark standoff holes.

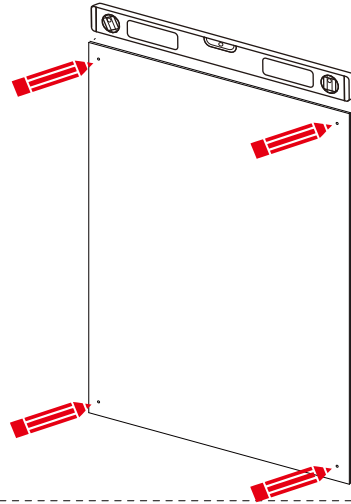

Step 1

Secure the shelf standoffs with the provided screws from the back

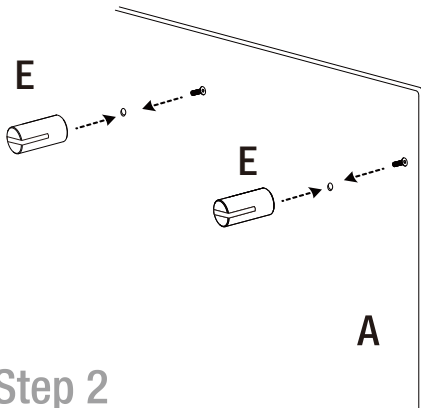

Step 2

Place your shelves into the shelf standoffs and secure by tightening the set screws with provided hex wrench.

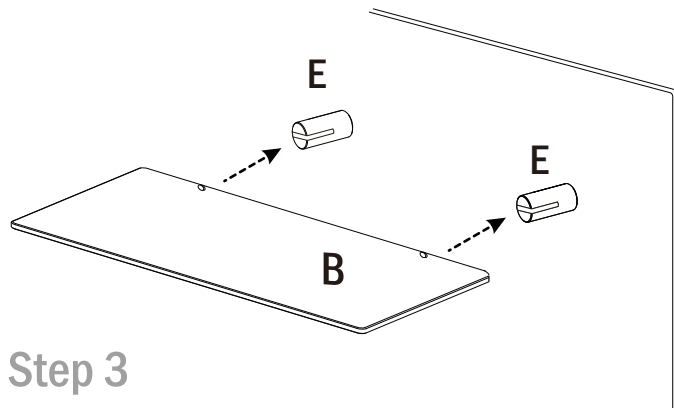

Step 3

Install the standoffs on the marked spots on the wall

Step 4

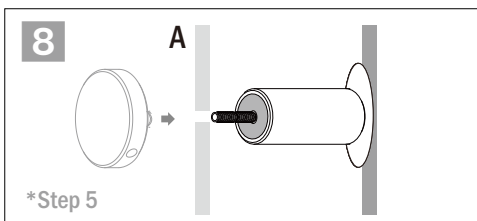
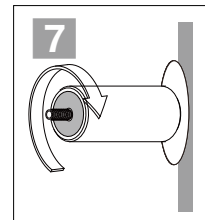
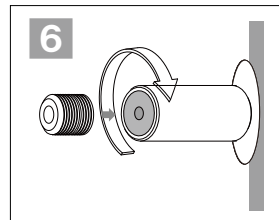
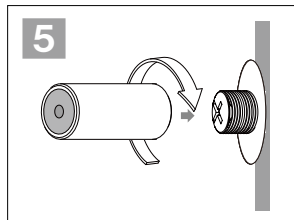
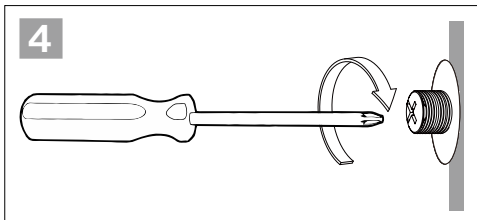
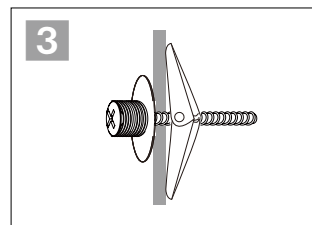
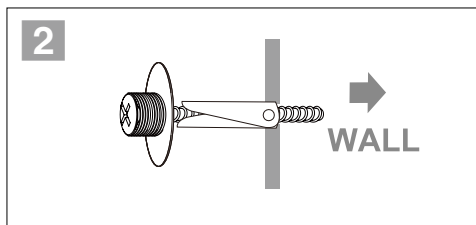
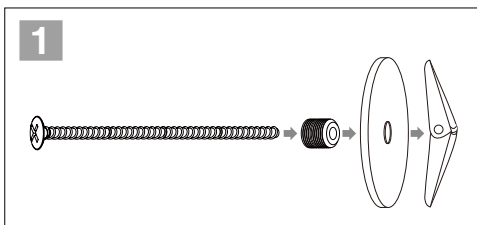

Place the complete panel and shelves on to the standoffs and secure them with the caps

