

US DOOR™

& BUILDING COMPONENTS

roll·lite®
STORAGE SYSTEMS

U.S. Door's new line of portable storage buildings, provides you with additional storage units when you need them - RiteAway. Manufactured completely from hot-dipped galvanized steel components and available in pre-finished colors, these buildings will provide you a lifetime of rentable income. Suitable for existing sites requiring a few more units, or sites with potential customers waiting for new buildings to arrive, these portables start your rental income when you most want it – RiteAway. As fully portable units, these buildings also qualify for multi-year equipment leasing packages. Let U.S. Door show you how to add immediate profits with minimal upfront costs.

Standard Building Sizes:

- 20' x 8'
- 20' x 10'

Standard Building Floor:

- Aluminum Diamond Plate

Standard Building Foundation:

- Equipped with a 2.5" Skid Plate
- Rated at 50 lbs. Per sq.ft. Floor Load
- 30 lb. Snow Load
- 110 mph Wind Load

Optional Building Foundation:

- Adjustable Height Skid Plate
- Rated at 125 lbs. Per sq.ft. Floor Load

Other Popular Options:

- Wind Load Tie Downs
- Gutters and Spouts
- Standing Seam Roof
- 40 lb. Snow Load
- 50 lb. Snow Load
- 120 mph Wind Load
- Custom Options, Sizes, and Installation Available Upon Request

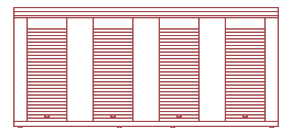
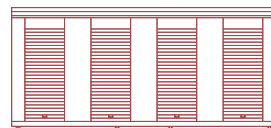
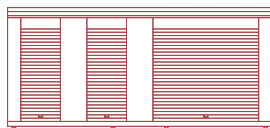
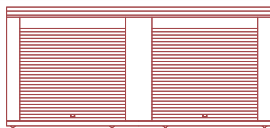
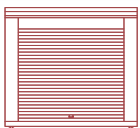
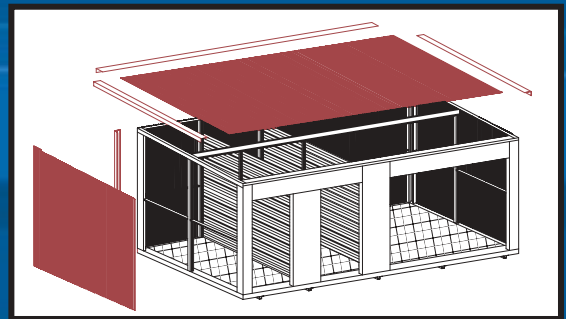

Model Number:
81/101

82/102

83/103

84/104

88/108

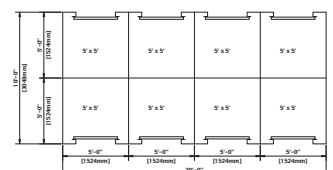
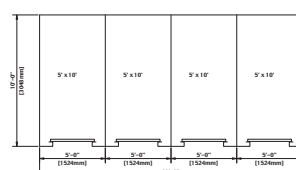
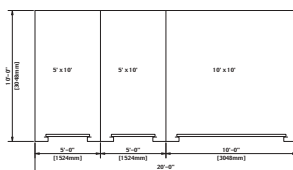
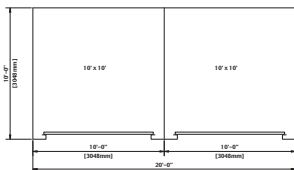

US Door & Building Components • www.usdoor.com

10407 Rocket Blvd. • Orlando, FL 32824
TEL 407 859-6770 • FAX 800 928-5276

1720 West Broadway Rd. • Mesa, AZ 85202
TEL 480 961-0846 • FAX 800 659-8886

US DOOR™

& BUILDING COMPONENTS

roll·lite®
STORAGE SYSTEMS



While researching alternative methods for the “Free Month” marketing technique utilized by many of today’s storage sites, U.S. Door developed a portable locker system. These ready-to-assemble lockers allow you to advertise storage at a low cost monthly rate, and not lose profits while doing it. Starting at only \$125.00 per unit, these lockers can offer added rentable space to any facility. Fitting behind stairwells, in oversized hallways, or stacked together in unrentable units, these low cost lockers turn your now empty units into money making locker units. Various configurations and sizes are available. All units are boxed for UPS shipping. No drilling is required; all holes are pre-punched for ease of assembly. Call today for more information and pricing.

Standard Sizes:

- 24”x 24”x 48” *
- 36”x 36”x 48” *
- 24”x 24”x 96” - single door
- 36”x 36”x 96” - single door

* Available for Quick Ship by UPS

Standard Features:

- Completely Bolt Together
- All Required Fasteners Included
- Slide Lock Included
- Optional Shelving Package Available
- Custom Sizes Available Upon Request

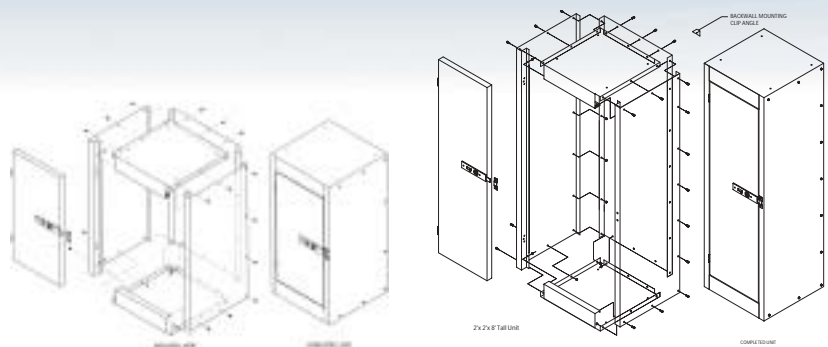

Roll-up Doors • Corridor • Locker Units • Swing Doors • Mezzanines • Portable Storage

US Door & Building Components • www.usdoor.com

10407 Rocket Blvd. • Orlando, FL 32824
TEL 407 859-6770 • FAX 800 928-5276

1720 West Broadway Rd. • Mesa, AZ 85202
TEL 480 961-0846 • FAX 800 659-8886