

Crosby® Swivel Hooks



L-3322B
Swivel Hooks
with Bearing

New anti-friction bearing design allows hook to rotate freely under load.

- Capacities ranging from 2 through 15 metric tonnes.
- Forged - Quenched and Tempered.
- Proper design, careful forging, and precision controlled quench and tempering gives maximum strength without excessive weight and bulk.
- Low profile hook tip designed to utilize Crosby S-4320 or PL-N latch kit. Simply purchase the latch assemblies listed and shown on pages 121 - 123. Even years after purchase of the original hook, latch assemblies can be added.
- L-3322 hooks incorporate markings forged into the product which address two (2) **QUIC-CHECK®** features:
 - **Deformation Indicators** — Two strategically placed marks, one just below the shank or eye and the other on the hook tip, which allows for a QUIC-CHECK® measurement to determine if the throat opening has changed, thus indicating abuse or overload
 - **Angle Indicators** — Indicates the maximum included angle which is allowed between two (2) sling legs in the hook. These indicators also provide the opportunity to approximate other included angles between two sling legs.

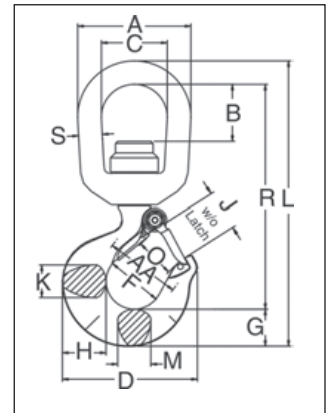

For other swivel hooks designed to rotate under load, see pages 117, 119, 120, 127, 128, 136-139. Use in corrosive environment requires shank and nuts inspection in accordance with ASME B30.10-1.10.4 (b)(5)(c) 2009.

L-3322B Swivel Hooks with Bearing

Working Load Limit (t)*	Hook ID Code*	L-3322B Stock No.†	Weight Each (lbs.)	Dimensions (in.)														Rep. Latch Stock No.	
				A	B	C	D	F	G	H	J	K	L	M	O	R	S		AA**
2	G	1028609	2.5	3.00	1.50	1.75	3.59	1.50	1.00	1.16	1.06	.88	7.64	.88	1.00	6.01	.63	2.00	1096421
3	H	1028618	3.8	3.50	1.56	2.00	4.00	1.62	1.13	1.31	1.19	.94	8.60	.94	1.09	6.72	.75	2.00	1096468
5	I	1028627	7.0	4.00	1.56	2.25	4.84	2.00	1.44	1.63	1.50	1.31	10.32	1.13	1.36	8.00	.88	2.50	1096515
7	J	1028636	14.0	5.00	1.94	2.75	6.27	2.50	1.81	2.06	1.78	1.66	12.84	1.44	1.61	9.90	1.13	3.00	1096562
11	K	1028645	22.3	5.62	2.05	3.12	7.54	3.00	2.25	2.63	2.41	1.88	15.24	1.63	2.08	11.74	1.25	4.00	1096609
15	L	1028654	36.0	7.12	3.62	4.10	8.33	3.25	2.59	2.94	2.62	2.19	18.64	1.94	2.27	14.41	1.50	4.00	1096657

* Proofload is 2.5 times working load limit. Designed with a 4.5 to 1 design factor. ** Deformation Indicators. † Supplied with latch attached.

WESTECH RIGGING SUPPLY

Call Toll Free: 800-442-7475

Call Us or Visit Our Stores:
Monday - Friday, 8:00am - 5:30pm Pacific



Distributed By

Visit Us Online at: www.WestechRigging.com

4140 West 11th Avenue
Eugene, Oregon 97402

2439 McGilchrist St SE
Salem, Oregon 97302

McKissick® HOIST HOOKS

WARNINGS & APPLICATION INSTRUCTIONS



L-320N Series



S-319 Series



L-322 Series
Positioning Only



L-3322B Series

WARNING

- Loads may disengage from hook if proper procedures are not followed.
- A falling load may cause serious injury or death.
- See OSHA Rule 1926.1431(g)(1)(i)(A) and 1926.1501(g)(4)(iv) (B) for personnel hoisting by cranes and derricks, and OSHA Directive CPL 2-1.36 - Interim Inspection Procedures During Communication Tower Construction Activities. A Crosby 319, L-320 or L-322 hook with a PL latch attached and secured with a bolt, nut and cotter pin (or toggle pin) may be used for lifting personnel. A Crosby 319N, L-320N or L-322N hook with an S-4320 latch attached and secured with cotter pin or bolt, nut and pin; or a PL-N latch attached and secured with toggle pin may be used for lifting personnel. A hook with a Crosby SS-4055 latch attached shall NOT be used for personnel lifting.
- See OSHA Directive CPL 2-1.36 - Crosby does not recommend the placement of lanyards directly into the positive locking Crosby hook when hoisting personnel. Crosby requires that all suspension systems (vertical lifelines / lanyard) shall be gathered at the positive locked load hook by use of a master link, or a bolt-type shackle secured with cotter pin.
- Threads or Split-Nut may corrode and/or strip and drop the load.
- Remove securement nut to inspect or to replace S-322 and S-3319 bearing washers (2).
- Hook must always support the load. The load must never be supported by the latch.
- Never apply more force than the hook's assigned Working Load Limit (WLL) rating.
- Read and understand these instructions before using hook.

QUIC-CHECK® Hoist hooks incorporate markings forged into the product which address two (2) QUIC-CHECK® features:

Deformation Indicators - Two strategically placed marks, one just below the shank or eye and the other on the hook tip, which allows for a QUIC-CHECK® measurement to determine if the throat opening has changed, thus indicating abuse or overload.



To check, use a measuring device (i.e., tape measure) to measure the distance between the marks. The marks should align to either an inch or half-inch increment on the measuring device. If the measurement does not meet criteria, the hook should be inspected further for possible damage.

Angle Indicators - Indicates the maximum included angle which is allowed between two (2) sling legs in the hook. These indicators also provide the opportunity to approximate other included angles between two sling legs.

IMPORTANT SAFETY INFORMATION - READ & FOLLOW

- A visual periodic inspection for cracks, nicks, wear, gouges and deformation as part of a comprehensive documented inspection program, should be conducted by trained personnel in compliance with the schedule in ANSI B30.10.
- For hooks used in frequent load cycles or pulsating loads, the hook and threads should be periodically inspected by Magnetic Particle or Dye Penetrant. (Note: Some disassembly may be required.)
- Never use a hook whose throat opening has been increased, or whose tip has been bent more than 10 degrees out of plane from the hook body, or is in any other way distorted or bent. **Note: A latch will**

not work properly on a hook with a bent or worn tip.

- Never use a hook that is worn beyond the limits shown in Figure 1.
- Remove from service any hook with a crack, nick, or gouge. Hooks with a nick or gouge shall be repaired by grinding lengthwise, following the contour of the hook, provided that the reduced dimension is within the limits shown in Figure 1. Contact Crosby Engineering to evaluate any crack.
- Remove from service any hook which has threads corroded more than 20% of the nut engagement length.
- Never repair, alter, rework, or reshape a hook by welding, heating, burning, or bending.
- Never side load, back load, or tip load a hook. (Side loading, back loading and tip loading are conditions that damage and reduce the capacity of the hook). (See Figure 2.)
- Eye hooks, shank hooks and swivel hooks are designed to be used with wire rope or chain. Efficiency of assembly may be reduced when used with synthetic material.
- Do not swivel the L-322 or S-3319 swivel hooks while supporting a load. These hooks are distinguishable by hex nuts and flat washers.
- The L-3322 swivel hook is designed to rotate under load. The L-3322 is distinguishable from the L-322 by use of a round nut designed to shield bearing.
- The frequency of bearing lubrication on the L-3322 depends upon frequency and period of product use as well as environmental conditions, which are contingent upon the user's good judgment.
- The use of a latch may be mandatory by regulations or safety codes; e.g., OSHA, MSHA, ASME B30, Insurance, etc.. (Note: When using latches, see instructions in "Understanding: The Crosby Group Warnings" for further information.)
- Always make sure the hook supports the load. (See Figure 3). The latch must never support the load (See Figure 4).
- When placing two (2) sling legs in hook, make sure the angle from the vertical to the outermost leg is not greater than 45 degrees, and the included angle between the legs does not exceed 90 degrees* (See Figure 5).
- Reference Crosby's Hoist Hook Warning and Application Information for basic machining and minimum thread size.
- See ASME B30.10 "Hooks" for additional information.

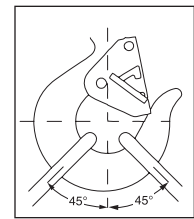
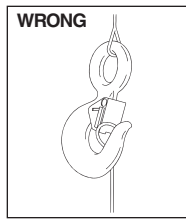
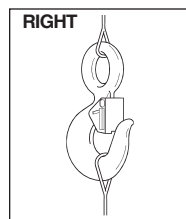
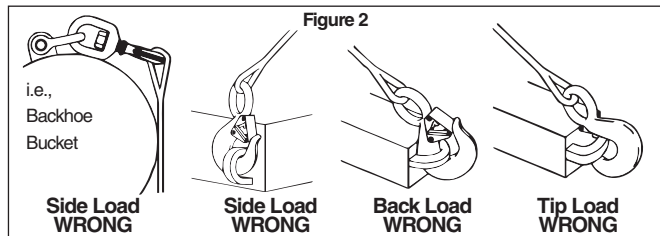
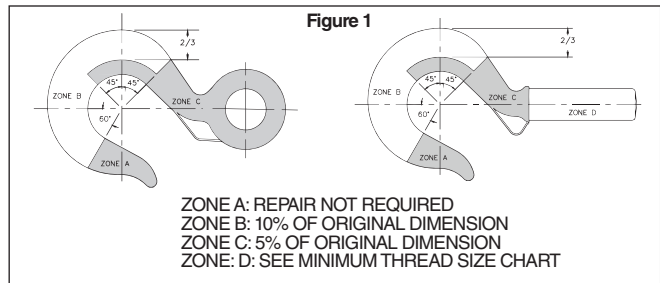

* For two legged slings with angles greater than 90 degrees, use an intermediate link such as a master link or bolt type shackle to collect the legs of the slings. The intermediate link can be placed over the hook to provide an in-line load on the hook. This approach must also be used when using slings with three or more legs.

Removal of Split-Nut assembly (Reference Figure A):

- Remove vinyl cover.
- Remove spring retaining ring.
- Slide steel keeper ring off split nuts **⚠ (CAUTION: Removal of keeper ring will allow split nut halves to fall from hook shank).**
- Remove split nut halves.

Inspection of split nut assembly and hook shank interface area (Reference Figure B):

- Inspect hook shank and split nut for signs of deformation on and adjacent to the load bearing surfaces.
- Inspect outside corner of hook shank load bearing surface to verify the corner is sharp.
- Verify retaining ring groove will allow proper seating of the retaining ring.
- Inspect retaining ring for corrosion or deformation. Remove from service any retaining ring that has excessive corrosion or is deformed.
- Use fine grit emery or crocus cloth to remove any corrosion from machined hook shank and split nut assembly.
- Follow inspection recommendations listed in this document under IMPORTANT SAFETY INFORMATION.
- If corrosion is present on the nut / shank interface area and deterioration or degradation of the metal components is evident, further inspection is required.
 - The use of a feeler gauge is required to properly measure the maximum allowable gap width between the split nut inside diameters and shank outside diameters.
 - With one split nut half seated against the hook shank, push the nut to one side and measure the maximum gaps as shown in Figure B. The hook should be measured in four places, 90-degrees apart.
 - Repeat above inspection procedure with other half of split nut.
 - Remove from service any hook and split nut assembly that exhibits a gap greater than 0.030".

Installation of split nut assembly (Reference Figure A):

- Coat hook shank and inside of split nut with an anti-seize compound or heavy grease.
- Install split nut halves onto shank. The flanged bottom of the split nut should be closest to the hook shoulder.

- Slide steel keeper ring over split nut halves. Verify the split nut halves properly seat against the load bearing surface of the hook shank and the steel keeper ring seats against the flange of the split nut.
- Install retaining ring onto split nut halves. Verify the retaining ring seats properly in the retaining ring groove on the outside diameter of the split nut assembly.
- Install vinyl cover over split nut and hook shank assembly.
- Verify all fasteners are correctly installed.
- Always use Genuine Crosby replacement parts.

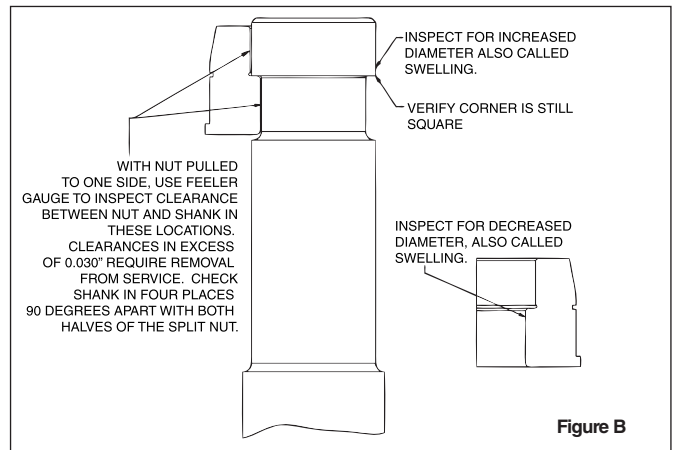
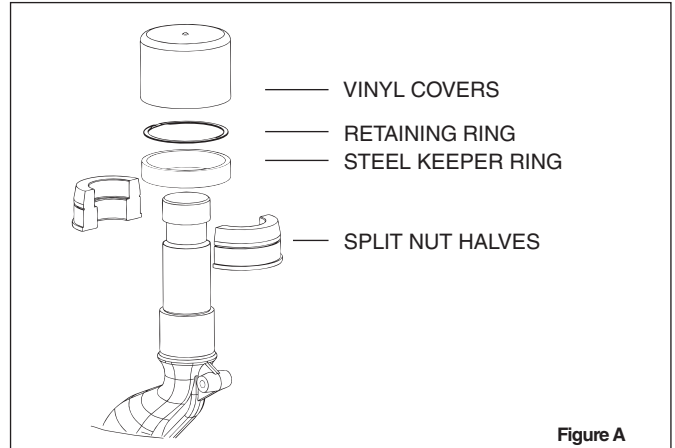

Warning and Application Instructions For McKISSICK® Hook Latch Kit

IMPORTANT SAFETY INFORMATION - READ & FOLLOW

- Always inspect hook and latch before using.
- Never use a latch that is distorted or bent.
- Always make sure spring will force the latch against the tip of the hook.
- Always make sure hook supports the load. The latch must never support the load. (See Figures 1 & 2)
- When placing two (2) sling legs in hooks, make sure the angle between the legs is less the 90° and if the hook or load is tilted, nothing bears against the bottom of this latch. (See Figures 3 & 4)
- Latches are intended to retain loose sling or devices under slack conditions.
- Latches are not intended to be an anti-fouling device.

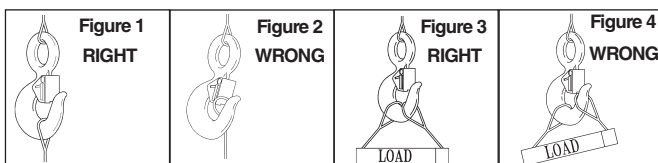

⚠ WARNING

- Loads may disengage from hook if proper procedures are not followed.
- A falling load may cause serious injury or death.
- See OSHA Rule 1926.1431(g)(1)(i)(A) and 1926.1501(g)(4)(iv) (B) for personnel hoisting for cranes and derricks. Only a Crosby or McKissick hook with a PL Latch attached and secured with bolt, nut and cotter (or Crosby Toggle Pin) or a Crosby hook with a S-4320 Latch attached and secured with a cotter pin, or a Crosby SHUR-LOC® hook in the locked position may be used for any personnel hoisting. A hook with a Crosby SS-4055 latch attached shall NOT be used for personnel lifting.
- Hook must always support the load. The load must never be supported by the latch.
- Do not use this latch in applications requiring non-sparking.
- Read and understand these instructions before using hook and latch.