



**AUTOPILOT**  
PURIFYING SYSTEMS

# Pool Pilot® Digital

## Salt Chlorine Generator

Swimming Pool & Spa Purification System

Model: DIG-220



## Owner's Manual

### Installation and Operation

This manual covers the installation and operation of the DIG-220 Chlorine Generator with associated manifold assembly.

### **IMPORTANT !**

**Read This Manual Before  
Installing or Operating**

**INSTALLER: THIS DOCUMENT IS PURCHASER'S PROPERTY AND IS TO REMAIN WITH THE EQUIPMENT OWNER**

# TABLE OF CONTENTS

<b>CONTACTING THE FACTORY .....</b>	<b>4-5</b>
<b>SAFETY INFORMATION .....</b>	<b>5-6</b>
<b>OWNER QUICK START &amp; RUN .....</b>	<b>7-10</b>
<b>SPECIFICATIONS .....</b>	<b>11</b>
Input Power .....	11
Output Power .....	11
Optional Internal Pump Relay Ratings .....	11
Chlorine Output .....	11
Manifold Flow Requirements .....	11
Agency Approvals .....	11
<b>INSTALLATION .....</b>	<b>11-16</b>
Before Installing: .....	11
What is included: .....	11
What is not included: .....	11
Required Components for a complete system: .....	12
Installation Steps: .....	12
Plumbing the Manifold Assembly .....	12
Flow Rates Within Normal Range: .....	13
Flow Rates Exceeding 100-gpm (379 L/m): .....	13
Mounting the Control Unit: .....	13-14
Electrical Connections .....	14-16
Grounding and Bonding .....	14
Determine Incoming Voltage Requirements .....	14
For incoming voltage of 230 Vac: .....	14
For incoming voltage of 115 Vac: .....	15
Connecting DIG-220 to External Equipment .....	15
Connecting DIG-220 to External Time Clock: .....	15
Connecting DIG-220 to Control a One-Speed Pump .....	16
Connecting DIG-220 to Control a Two-Speed Pump .....	16
Cell and Tri-Sensor Cord Connections .....	16
<b>PREPARING THE POOL WATER .....</b>	<b>17</b>
Steps to Prepare Water: .....	17
Calculating Pool Volume: .....	17
Adding Salt: .....	17
Type of Salt to Add... ..	17
Determine Amount of Salt Required (and salt level to maintain)... ..	17
How to add the salt (or remove it if too much)... ..	17
<b>MENU OVERVIEW .....</b>	<b>18</b>
<b>ACCESS TO PROGRAMMING .....</b>	<b>18-23</b>
Control Panel: .....	18
Operation of Buttons: .....	18-19
Menu Button .....	18
Select Button .....	18
Pump Button .....	18-19
Basic Operational Programming: .....	19
Adjusting the Purifier Output % ... ..	19
Boost or SuperBoost... ..	19
Purifier Mode .....	19
Purifier % Adjustment Procedure: .....	19

# TABLE OF CONTENTS

Menus .....	20-23
Test Pool Pilot .....	20
View Setup .....	20
Owner Options: .....	20-21
Select Language: .....	20
Select Units: .....	21
Temperature Units .....	21
12/24 Hour Clock: .....	21
Set Time of Day: .....	21
Maintenance Menu: .....	21-22
Test Pool Pilot: .....	21
Set Time of Day: .....	21
Force Reverse .....	21
Set Reverse Time: .....	21
Replace Cell .....	22
Calibrating Temperature: .....	22
Calibrating Salt: .....	22
Installer Menu: .....	22-23
Select Language: .....	22
Select Units: .....	22
Temperature Units .....	22
12/24 Hour Clock: .....	22
Pool Volume .....	22
Cell Type .....	23
Cell Power .....	23
Pump Control .....	23
Set Time of Day .....	23
Select Remote: .....	23
Select Minerals: .....	23
Pump Program 1 and 2: .....	23
Enable Demo: .....	23
<b>REFERENCE SECTION .....</b>	<b>24-26</b>
Salt Addition Chart: .....	24
Basic Water Chemistry: .....	24-25
Using the Saturation Index (SI): .....	25-26
Part Numbers: .....	26
<b>MAINTENANCE .....</b>	<b>27-30</b>
Fuse Location and Ratings: .....	27
Removing \ Inspecting \ Cleaning the Tri-Sensor .....	27-28
Testing the Flow Switch, Cleaning the Filter Screen, Cleaning the Bypass Valve .....	28
Servicing the SuperCell .....	28-29
Visual Inspection of the SuperCell... ..	29
Manual Cleaning of the SuperCell... ..	29
Installing a SuperCell... ..	29
Winterizing .....	30
Freeze protection program and its limits .....	30
Spring Start-Up .....	30
<b>TROUBLESHOOTING .....</b>	<b>31-32</b>
<b>APPENDIX .....</b>	<b>33</b>
Delaration of Conformity .....	33
FCC Compliance .....	33

# CONTACT INFORMATION

## Dear Owner:

Congratulations on your wise decision to make an AquaCal AutoPilot chlorinator a part of your home. Just add salt, and let your DIG-220 produce the chlorine to sanitize your pool or spa.

A wonderful thing happens to the salt after it is turned into chlorine and does the work of purifying the water—it turns back into salt and the process begins all over again.

Plus, the salt, being at a much lower level than even contact lens solutions, means no “salty” taste to the water for the average bather. And, no more odors from harsh chlorine products.

No longer experience the discomfort and inconvenience of harsh chemical reactions like red eyes, green hair, itchy skin, or faded swim wear. Our product makes it easy to retain a constant level of chlorine, purifying the water while making it soft and silky to the touch.

“You can rest assured knowing your new chlorinator is of the highest quality and efficiency, and is designed and built to provide years of trouble-free operation.”

## What We Need to Know If You need To Contact Us...

If you should need to call AquaCal AutoPilot for questions, service, or parts, please have the following information ready:

### 1 INSTALLER - Please record the following information prior to installation:

Installer: _____	Date of Installation: _____
Control Unit Model Type: <i>DIG-220</i>	Control Unit Serial Number: _____
SuperCell Model Type: _____	SuperCell Serial Number: _____
Pool Volume in Gallons: _____	

### 2 CHEMISTRY: (from a current water sample) NOTE RECOMMENDED LEVELS ON PAGE-24 & 25.

Approximate Water Temperature of pool: _____	Total Chlorine (TC): _____
Salt Level: _____	Combined Chlorine (CC): _____
Stabilizer (CYA): _____	Free Chlorine (FC): _____
Calcium Hardness: _____	Total Alkalinity: _____
	pH: _____

### 3 “VIEW SETUP” and “TEST POOL PILOT” information

Use the view set up menu, and test pool pilot menu and write down the results (see programming on page-20)







# SAFETY INFORMATION







(CONTINUED)

**IMPORTANT SAFETY INSTRUCTIONS  
READ AND FOLLOW ALL INSTRUCTIONS  
SAVE THESE INSTRUCTIONS**

All DIG-220 models:

<b>WARNING</b> 	<b>Risk of Electrical Shock.</b> Ensure that the electrical panel or filter pump circuit is turned OFF prior to installation or servicing inside any Autopilot unit.
<b>WARNING</b> 	<b>Risk of Electrical Shock.</b> Mount the Control Box to ensure the least amount of direct exposure to rain, garden sprinkler water, direct sunlight, or any corrosive environment.
<b>WARNING</b> 	<b>Risk of Electrical Shock.</b> Install the Control Box at least 10' (3 m) for 115 Vac Units, from the inside wall of the pool or spa. Use 5' (1.5 m) minimum distance for 230 Vac Units.
<b>WARNING</b> 	<b>Failure to heed the following may result in permanent injury or death.</b> Do not permit children to use this product unless they are closely supervised at all times. Children should not use spas, hot tubs, or pools without permanent adult supervision.
<b>WARNING</b> 	<b>To avoid personal injury</b> The proper residual chlorine level and water chemistry must be maintained.

Installation of fixed wiring DIG-220 (115/230Vac, 50/60 Hz):

<b>WARNING</b> 	<b>To avoid personal injury</b> All field-installed metal components such as rails, ladders, drains, or similar hardware within 10' (3 m) of the spa or hot tub shall be bonded to the equipment grounding bus with copper conductors not smaller than No.8 AWG (8.4 mm <sup>2</sup> ).
<b>WARNING</b> 	<b>To avoid personal injury</b> Use the bonding lug provided on the outside of your DIG-220, to connect a minimum No. 8 AWG (8.4 mm <sup>2</sup> ) solid copper bonding conductor between the DIG-220 and any metal equipment, metal enclosures of electrical equipment, metal water pipe or conduit within 5' (1.5 m) of the DIG-220.
<b>WARNING</b> 	<b>To avoid personal injury</b> A ground terminal is located on the inside of your DIG-220. To reduce the risk of electrical shock, this terminal must be connected to the grounding means provided in the electrical supply panel. A continuous copper wire is to be used equivalently sized to the circuit conductors supplying your DIG-220.
<b>WARNING</b> 	<b>To avoid personal injury</b> A disconnect device such as a time clock relay or circuit breaker from the power source, with a contact separation of at least 0.12" (3mm) in all poles, must be incorporated in the fixed wiring for permanently wired units.
<b>WARNING</b> 	<b>To avoid personal injury</b> The input voltage to the DIG-220 must match the 115/230Vac jumper terminals on the Circuit board, marked "TRANSFORMER PRIMARY" (shown on Page-14 & 15).
<b>WARNING</b> 	<b>To avoid personal injury</b> The Control Box is provided with (3) knock out holes for electrical conduit connections and has (1) 1/2" Liquidite fitting already attached. 1/2" nonmetallic flex conduit is recommended.

# OWNER QUICK START & RUN

The Pool Pilot DIG-220 is a salt chlorination system designed for pool or spa water purification. Although the DIG-220 is easy to use, it is important to read through the entire manual before attempting to operate the system.

## How Your Chlorine Generator Works

The system requires a low concentration of dissolved salt (sodium chloride) in the water. The salt concentration level is normally maintained below the taste threshold. The DIG-220 automatically converts the salt into chlorine, which your pool/spa requires to remain sanitized and algae free. The chlorine reverts back to salt after treating the water.

Since the salt is constantly recycled, there is minimal loss during a swimming season. However, salt can be lost due to filter backwashing, rain water overflow, leaks, or bather splashing/carry out... but not through evaporation.

The amount of chlorine required for proper sanitization will vary based on the pool size and various factors such as water temperature, bather load, exposure to direct sunlight, and special water features.

The water circulation pump must be operating for your DIG-220 to produce chlorine, so run time is one of several key components to maintaining the proper sanitizer levels.

**Most installations require a minimum of eight (8) hours-per-day pump run time** to properly filter and sanitize the water.



## Control Overview

Following is a brief explanation of owner / operator control options. For full features of the Owner Options Menu, please see page-20 & 21. The MENU button is pressed to obtain access to the Owner Options Menu.

**Please Note:** This quick start section assumes the installer has already programmed the system for specific site parameters, has established proper water balance, and has pretreated water to 1 - 3 ppm chlorine.

**Attention Owner:** Should Celsius vs. Fahrenheit, choice of language, or other owner options require modification, please refer to *Operation of Buttons* located on page-18 and *Owner Options* on page-20 & 21.

### *Up and Down Arrows:*

Use the UP and DOWN arrows to control the **purifier output level**, then press the SELECT button to save the value chosen. With a properly prepared pool, the recommended starting output level is 50%.

Upon initial start-up, check sanitizer level every few days and make small output level adjustments as necessary to maintain 1-3 ppm free chlorine levels.

Your DIG-220 does *not* directly measure or regulate the sanitizer levels in your pool. Rather, the owner / operator will need to periodically test the water to determine the current chlorine level, and adjust the **output setting** as needed.

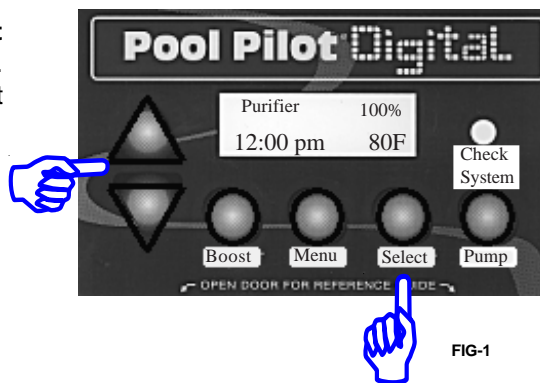

FIG-1

After the purifier output level is “tuned in,” the unit will automatically make fine output adjustments as the water temperature fluctuates. This **patented** temperature compensation feature will adjust output depending on water temperature. See page-10 & 30 for more information concerning the temperature compensation feature.

**Please Note:** The **optimum output setting** will vary based upon pool size, location, exposure to sunlight, number of users, vegetation around the pool, water balance practices, and pump run time. Your installer should have already taken these factors into consideration when performing installation programming. Therefore, your adjustments, at this point, should be relatively minor.



# OWNER QUICK START & RUN

## ***The Boost Button:***

The BOOST button increases output to 100%. Use this feature when a heavier than normal bather load is anticipated.

Press BOOST **once**..... = 24-Hour Boost

Press and hold BOOST for 8 seconds = 72-Hour Boost

Press BOOST a second time..... = Deactivate Boost

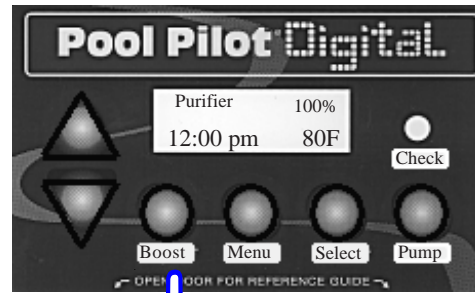

FIG-2

## ***Menu and Select Button:***

Allows access to the “Test,” “View Setup,” “Owner Options,” “Maintenance,” and “Installer” menus. The SELECT button allows the operator to choose program menu options. The owner / operator should not normally need to access these features on a regular basis. Consult “Programming” section or contact factory customer support for additional information.

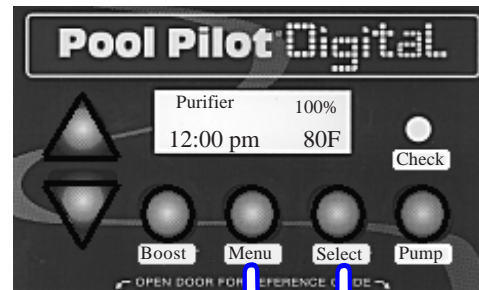

FIG-3

## ***Check System Light:***

The CHECK SYSTEM light will flash to warn the DIG-220 may need attention. A warning message will also be displayed. Unless deemed a normal condition, per below, see troubleshooting section beginning on page-31.

- Flashes if the water flow is insufficient under the following circumstances:
  - When DIG-220 is not set up to control the water pump (uses an External Timer or Remote Runs Pump), and DIG-220 is wired to the line side (hot all the time).
  - If the DIG-220 controls the pump (One-speed Pump), the light will not flash when the pump is off.
- Flashes when salt is low
- Flashes when water temperature exceeds 125° F, or drops below 10° F
- Flashes when “PUMP OFF FOR SERVICE”

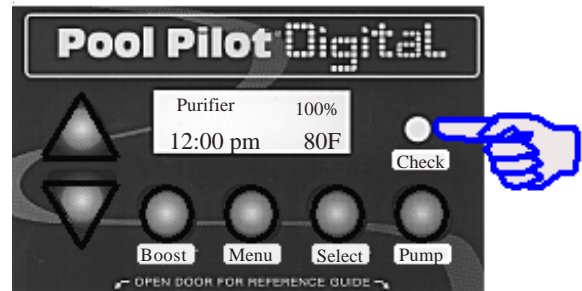

FIG-4

## **Normal Display:**

After 30-minutes of inactivity, the display will go to a “walking dot” screen saver mode. All functions such as chlorine generation, reverse, boost, etc., will continue in the background. Pressing any key will call up the normal informational display.

- Purifier Output level ..... : In 1% increments, from 0% to 100%
- Water Temperature ..... : In Fahrenheit or Celsius
- Cell Status ..... : ON
- Check System Light ..... : OFF



# OWNER QUICK START & RUN

(CONTINUED)

## Water Balance & Chemistry Recommendations

Proper water balance is critical to the operation of your DIG-220.

Conditions such as high pH levels, low cyanuric acid (stabilizer) levels, or other factors causing *unbalanced water*, will mask the sanitizer production of your DIG-220. Please note the following recommended water chemistry parameters:

PH.....	: 7.2 – 7.8
Calcium Hardness.....	: 200 – 400 ppm
Total Alkalinity.....	: 80 – 100 ppm
Salt.....	: 2500 – 3500 ppm (ideal 3000 ppm)
Cyanuric Acid (stabilizer).....	: 60 – 80 ppm
Chlorine.....	: 1 – 3 ppm

See “Basic Water Chemistry,” on page-24 & 25, and “Using the Saturation Index,” on page-25 & 26 for further information concerning pool/spa water chemistry maintenance requirements.

Should you have additional water balance or chemistry questions, please refer to the *Troubleshooting* section in the back of this manual.

# Important !!!

## Information Critical to the Survival of Your DIG-220 Follows...

### Winterizing

#### NOTICE

**Failure to heed the following may result in equipment damage.**

Special measures are required in the event of freezing conditions. Your DIG-220 may be damaged if measures are not taken in advance of freezing conditions. Equipment damage due to freezing conditions is NOT covered under the equipment warranty.

### Freeze Protection & Extended Shut Down:

In areas where freezing conditions are a rare occurrence, allow the filtration system to run continuously throughout the freeze period. Typically, during light freeze conditions, circulating (moving) water will not freeze.

In areas where freezing conditions are prevalent and sustained, the DIG-220 MUST be winterized; please refer to winterizing instructions on page-30.

# OWNER QUICK START & RUN

(CONTINUED)

## Important Features

- Patented temperature compensation for chlorine output control...
- Programmable microprocessor control...
- Multi-language digital display (English, Spanish, Italian, & French)...
- Digitally controlled power to the SuperCell...
- Tri-sensor circuitry to monitor water flow, water temperature, and salt level. Calculates and provides recommended salt addition amounts required to maintain the recommended 3000 ppm (3.0 g/l) salt concentration level.
- Freeze Protection: allows the water pump, if wired and programmed for One-Speed pump, to override the program cycle and run continually (30-minute minimum) when the water temperature falls below 40° F (4.4° C). This helps to prevent damage to the plumbing during light freeze conditions.
- Optional Internal relay for controlling an external single-speed or two-speed water pump.
- On-board diagnostic and test programs.
- Lithium battery back up for saving program settings.
- ORP dry contact interface for connection to an external ORP controller.
- Optional Electronic controller interface for Jandy® (Versions I,K, and newer), Polaris® EOS, or Pentair IntelliTouch® controllers.

## Patented Temperature Compensation

The Tri-Sensor temperature sensor works in conjunction with the purifier % feature to automatically adjust chlorine output based upon changes in water temperature. The automatic compensation feature operates between 55°F and 95°F (13°C - 35°C).

As water temperature falls below 65°F (18°C), the controller will activate a high purifier percent lockout, and may not allow purifier adjustments up to 100%. This feature prevents the controller from overworking the cell under colder temperatures, thus preventing premature cell wear.

At 55°F (13°C) or colder water temperatures, the controller will adjust to a fixed 1% output (and will not allow the percentage to be raised manually), thus preventing over-chlorination and premature cell failure.

As the water temperature rises above set point, the controller will increase output up to 100%, thus preventing under-chlorination during warmer water temperatures.

## Water Manifold Assembly

The DIG-220 may be operated with the Patented (Automatic-Flow Bypass) Manifold using the following Super Cells: SC-36, SC-48, SC-60, or CC-15. Please see Installer section: "Basic System Overview," for details and diagrams.

## Get the Most from Your Purchase!

**To become fully-familiar with all the features, the safe operation, and the care of your new chlorinator, please read through the entire remainder of this manual.**

# SPECIFICATIONS

This device complies with part 15 of the FCC Rules. Operation is subject to the following two conditions: (1) This device may not cause harmful interference, and (2) this device must accept any interference received, including interference that may cause undesired operation.

## Input Power:

230 Vac (1.5 AC amps) 50/60 Hz (default from factory)  
 115 Vac (3AC amps) (easily converted in the field, refer to page-14 & 15 for instructions on conversion)

## Output Power:

Cell Power 1 (5\* DC amps)  
 Cell Power 2 (6.5\* DC amps)  
 Cell Power 3 (8\* DC amps)  
 \* Indicates nominal amperage output. The dual axis controller will slightly vary the amps to optimize the power to the cell.

## Optional Internal Pump Relay Ratings:

Voltage Input ..... Amps / HP max  
 115 Vac ..... 30 amps / 1 HP  
 230 Vac ..... 30 amps / 2.5 HP

## Chlorine Output:

@ Cell Power 3 (8 amps DC) (set at 100% - 24 hour operation)  
 CC-15            2.50 lbs/day (1.13 kg/day)  
 SC-60            1.92 lbs/day (0.88 kg/day)  
 SC-48            1.56 lbs/day (0.71 kg/day)  
 SC-36            1.28 lbs/day (0.58 kg/day)

## Manifold Flow Requirements:

Maximum Operating Pressure: 50 psi  
 Maximum Flow Rate: 100 gpm  
 Minimum Flow Rate: 20 gpm

## Agency Approvals:

ETL tested to conform to UL1081 specification. Standard for Safety for Swimming Pool Pumps, Filters and Chlorinators.  
 NSF/ANSI 50 ..... Circulation System components and related materials for swimming pools, spas/hot tubs.  
 CAN/CSA-E335-1 ..... General Requirements For Safety of Household and Similar Electrical Appliances.  
 See appendix on page-33 for CE Declaration of Conformity

## A Note Concerning Terminology:

Throughout this manual, the portion of the system which mounts to the wall (and powers the cell) may be referred to as the: *DIG-220 or unit*. In addition, when "pool" is referred to in the absence of the word "spa," it should be assumed "spa" is inferred (should a spa be present in the installation).

**Installer... Please record the following information on page-4 of this manual:**

- Date of Installation
- SuperCell Type
- Control Unit Model
- SuperCell Serial Number
- Control Unit Serial Number

**For questions concerning installation or operation of this equipment:**

Visit [www.autopilot.com](http://www.autopilot.com) for latest manual revisions and helpful troubleshooting tips.  
 You can also contact AquaCal AutoPilot customer support as specified on page-5 of this manual.

## Before Installing:

- Determine everything needed for installation is on hand.
- Determine where the Manifold Assembly will be plumbed.
- Identify a suitable mounting location for the DIG-220 within proper cord length to the manifold. If possible, avoid locations with direct sunlight, sprinklers, etc.
- Plan runs for SuperCell and Tri-Sensor Cables. (Cables are 12' or 3.65M)
- Plan wire runs and wiring connections for source power.
- Determine origination point for control center power feed:
  - Directly from a circuit breaker... } Circuit breaker is used to power the DIG-220 and circulation pump.
  - From an external timer, or } DIG-220 is to be wired to the same location as the circulation pump; the unit is activated only when the
  - From an electronic controller } circulation pump is energized.
- Determine whether the input voltage for the DIG-220 will be 115-Vac or 230-Vac
- Determine whether the DIG-220 will be used to control a single speed or a two speed pump. (Optional pump relay must be installed)
- Determine whether the DIG-220 will be controlled by an ORP controller.
- Determine whether the DIG-220 will be controlled by an Electronic Controller System.

## What is included:

Although the manifold assembly may be sold separately, both a manifold and a Digital Control Center are required for a complete installation. The standard cell & manifold assembly is available with the following cells: SC-36, SC-48, SC-60, and CC-15. Before attempting the installation, verify the following items have been included with the Control Center:

Quantity	Item Description
1	DIG-220 Control Center / Power Supply
4	Screws and Screw Anchors
1	Drilling Template
1	Manual
1	6 amp fuse, and wire jumper kit
1	Super Cell Cable
2*	68mm x 2" metric adaptors (#19059)

\* European systems only

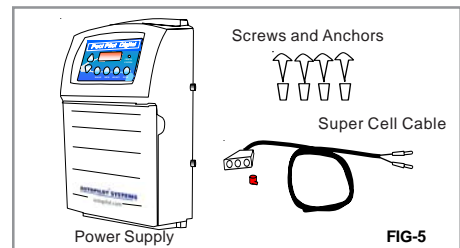

## What is not included:

- Power service electrical wire.
- ½" liquid tight (nonmetallic flex) conduit.

# INSTALLATION

## Required Components for a complete system:

### Automatic-Flow Bypass Manifold Assembly:

The manifold is connected into the plumbing after all other equipment. Water from the pool/spa is moved through the manifold by the circulation pump. The manifold's four key components are the: Strainer Screen, Tri-Sensor, SuperCell, and Bypass Flow Valve (See FIG-7).

The **Strainer Screen** prevents debris in the water from entering the Tri-Sensor or SuperCell, and requires periodic inspection and cleaning.

The **SuperCell** receives power from the DIG-220 and converts the salt contained in the water to chlorine.

The **Bypass Valve** allows the water flow rate to be slowed and optimized through the SuperCell, while permitting the pump to continue to circulate water to-and from the pool/spa at full flow rates. The slowed water flow through the SuperCell results in a more efficient "Super-Chlorination" effect, resulting in improved overall sanitization.

The **Tri-Sensor** provides data (from electronic sensors) to the DIG-220 for monitoring water flow, water temperature, and salt concentration level. The DIG-220 uses this data to determine if conditions are safe for the SuperCell to operate; the signal read from the temperature sensor allows the automatic temperature compensation feature to function (See FIG-8).

When the water flow reaches a minimum flow rate of 20-gpm (76 L/m), the flow paddle magnet closes a micro-switch monitored by the Control Unit.

The **Control Unit** uses the Tri-Sensor dedicated salt sensor blades to measure the level of salt in the water.

The Control Unit uses the Tri-Sensor temperature sensor to determine water temperature. This measurement is required for the Patented Automatic Temperature Compensation feature to automatically adjust chlorine output as water temperature varies.

Less chlorine is needed in cold water, so chlorine output is automatically reduced as water temperature drops (avoiding excess chlorine production). Conversely, more chlorine is needed in warmer water, and production is automatically adjusted higher as water temperatures increase.

*Note: The use of high strength magnet devices in the close proximity of the Tri-Sensor can cause the flow switch to function incorrectly.*

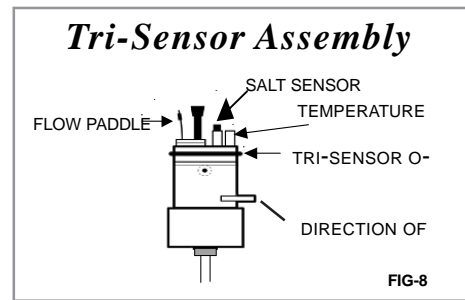
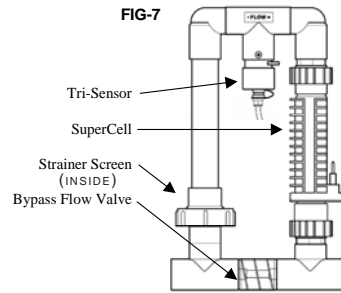

## Installation Steps:

Details on each step of the installation process are presented on the following pages:

1. Plumbing the Manifold Assembly (page-12 & 13)
2. Mounting the Control Unit (page-13 & 14)
3. Electrical Connections
  - a. Grounding and Bonding (page-14)
  - b. Determine Incoming Voltage Requirements (page-14 & 15)
  - c. Connecting DIG-220 to External Equipment (page-15 & 16)
  - d. ORP Connection (page-16)
  - e. SuperCell cable (page-16)
  - f. Tri-sensor cable (page-16)
4. Preparing the Water (page-17)
5. Programming and Setup for Site Parameters. (page-18, 22, & 23)

## Plumbing the Manifold Assembly:

The Manifold Assembly is 2" Schedule 40 PVC, and is typically plumbed into the pool return line; and, if applicable, after the heater and spa return diverter valve. Installing the manifold in the spa return line, will cause an excessive amount of chlorine to be introduced into the spa, while the spa is in use and must be avoided.

**STEP-1:** Select the location for installing the manifold:

- It is recommended the manifold be installed prior to the installation of the Control Unit. The Control Unit must be installed close enough to the Manifold Assembly to allow the Tri-Sensor and SuperCell cables sufficient slack to enable component service and maintenance. The cables are 12' long.
- The assembly must be installed in a vertical orientation as illustrated in the diagram on page-13 (fig 9). This orientation prevents hazardous gas buildup in the system, should the flow switch fail to detect insufficient flow. **WARNING! Place manifold in vertical position ONLY.**
- The direction of the water flow through the manifold must be as indicated for the system to operate properly.
- For a Pool/Spa combination, the manifold must be located as the last component in the POOL RETURN LINE (to avoid over-sanitization of the spa).

# INSTALLATION (CONTINUED)

## Plumbing the Manifold Assembly Continued:

### Flow Rates Within Normal Range:

- The manifold can be directly plumbed into the system as shown.
- If the flow rate for the system is less than 20-gpm (76 L/m), a larger pump must be installed (or steps taken to improve flow rate).

*Note: Insure "proper" flow rates. some two-speed pumps may provide insufficient flow on low speed.*

\*One set of 68 mm x 2" metric adapters (#19059) are included with European Systems.

For other plumbing configurations, please contact the factory for assistance.

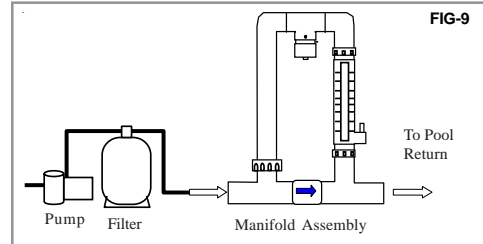

## Plumbing the Manifold Assembly:

### Flow Rates Exceeding 100-gpm (379 L/m):

*NOTE: 5-lb spring bypass check valve must be plumbed in parallel with the manifold.*

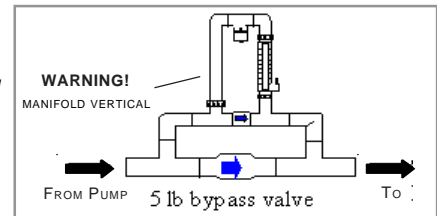

**STEP-2:** Install the cell into the manifold with the cell cable terminals at the bottom of the manifold as illustrated in picture (fig 10).

<b>NOTICE</b>	<b>Failure to heed the following may result in equipment damage.</b>
	If the cell is improperly installed upside down, water from rain or other sources may enter the cable contacts and result in failure of the Supercell. This would void the warranty.

**STEP-3:** Tighten the unions by hand for a watertight seal. The manifold will accept an SC-36, SC-48, SC-60 or CC-15 cell; use of any other cell may damage the power supply and the equipment warranty will be voided.

**STEP-4:** Follow the procedures outlined in the maintenance section on page-28to verify proper operation of the Tri-Sensor Flow Switch protection.

<b>NOTICE</b>	<b>Failure to heed the following may result in equipment damage.</b>
	It is extremely important to verify the safe and proper operation of the Tri-sensor's Flow Switch protection device before operating equipment.

<b>NOTICE</b>	<b>Failure to heed the following may result in equipment damage.</b>
	To avoid over-saturation conditions of your spa, it is suggested to locate the cell downstream of all other equipment and on the pool return line only. For applications other than as recommended, contact the factory.

## Mounting the Control Unit:

Your DIG-220 is suitable for indoor or outdoor mounting. If it is connected to 230 Vac, it must be installed at least 5' (1.5m) horizontal distance from the pool or spa wall (or more if local codes require). If it is connected to 115 Vac, it must be installed at least 10' (3m) horizontal distance from the pool or spa.

The DIG0-220 is designed to mount vertically on a flat surface with the wiring inputs facing downward. The enclosure is designed to allow heat to dissipate from inside the box. It is important not to block the top or bottom of the box. Do NOT mount the unit inside a panel or a tightly enclosed area without proper ventilation.

The cover of the DIG-220 is removed from the sides by four thumbscrews so it is advisable to leave adequate space on the sides for hand access to the thumbscrews.

When selecting a location for installing the DIG-220, please note that the Tri-Sensor and SuperCell cables are 12' (3.6m) long.

<b>NOTICE</b>	<b>Failure to heed the following may result in equipment damage.</b>
	Verify that the selected DIG-220 location is close enough to the Manifold Assembly so that the Tri-Sensor and Supercell cables will have enough slack for service or maintenance procedures.

Continued Next Page...

# INSTALLATION (CONTINUED)

## Mounting the Control Unit Continued:

Read the following section completely before proceeding (damage to wires and connectors may occur):

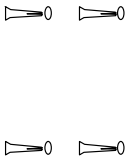
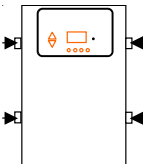
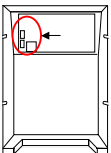
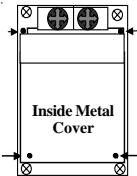
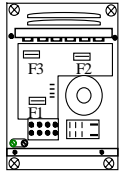
<p>1. Level and tape the mounting template to the selected mounting location. Mark the wall for the four (4) mounting holes.</p>  <p style="text-align: center;"><b>FIG-11A</b></p>	<p>2. Plastic anchors and screws have been provided for concrete or stucco walls. Drill and install anchors and screws. Leave a 1/4" gap from the wall when tightening the screws.</p>  <p style="text-align: right;"><b>FIG-11B</b></p>
<p>3. Loosen, but do not remove the four (4) thumbscrews on the sides of the unit cover. Carefully slide off the outer housing cover. Disconnect the 3 plugs that connect to the display (mounted inside the cover). The display circuit board does not need to be removed from the cover.</p>  <p style="text-align: center;"><b>FIG-11C</b></p>	<p>4. Safely set the cover aside.</p>  <p style="text-align: right;"><b>FIG-11D</b></p>
<p>5. Hang the DIG-220 on the four mounting screws. Using a long shaft slotted screwdriver, tighten the screws through the black plastic access holes.</p> <p>6. For access to the electrical terminal strip, remove the four screws and lift off the inner metal protective cover.</p> <p>7. Safely set the metal protective cover aside.</p>  <p style="text-align: center;"><b>FIG-11E</b></p>	<p>8. See <b>Electrical Connections</b> on page-14, 15, &amp; 16 for terminal connections.</p> <p>9. <b>After terminal connections have been made</b>, reverse steps 3-8 to re-install the metal and external covers.</p> <p>Make sure to route and connect the 3 cables through the side slot in the protective cover properly, then replace the outer housing cover after first connecting the 3 plugs (that were disconnected in step 3).</p>  <p style="text-align: right;"><b>FIG-11F</b></p>

## Electrical Connections

The DIG-220 uses both high and low voltage connections. High voltage connections will be made for providing the direct input power. Additional high voltage connections may be made to the filter pump from the DIG-220. Low voltage connections will be made to the Tri-Sensor and Supercell. Additional low voltage connections are provided for optional equipment such as a pH/ORP or electronic controller.

<h1 style="margin: 0;">WARNING</h1> 	<p style="text-align: center;"><b>Failure to heed the following may result in permanent injury or death.</b></p> <p>Insure the electrical panel or filter pump circuit breaker is turned OFF before wiring the DIG-220. Follow all state, local, NEC, CEC codes as applicable. AquaCal Autopilot recommends a licensed electrician or certified electrical contractor perform the electrical connections.</p>
---	---

## Grounding and Bonding

Connect a ground wire from the primary electrical input to the grounding lug located inside the box. Also ground any piece of high voltage equipment that is connected to the DIG-220 relay. The DIG-220 must also be connected to the pool bonding system with an 8 AWG (6 AWG for Canada) wire. A lug is provided on the bottom exterior of the unit.

## Determine Incoming Voltage Requirements

### AC LINE IN

The DIG-220 is pre-wired from the factory for 230 Vac using a 3-ampere fuse on the AC input. Short test leads are attached to the AC terminal strip **and must be removed prior to installation.**

if 115 Vac input power is required please follow steps in section entitled "For incoming voltage of 115 Vac" on pages-15.

### For incoming voltage of 230 Vac:

For incoming voltage of 230 Vac, confirm the "TRANSFORMER PRIMARY" is wired as indicated in FIG-11G.

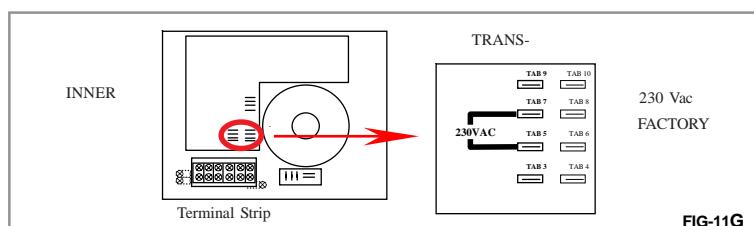

# INSTALLATION (CONTINUED)

## For incoming voltage of 115 Vac:

For incoming voltage of 115 Vac, re-wire the existing jumper then add the jumper wire provided in the installation kit, as shown on the circuit board marked "Transformer Primary". (see fig 12)

### Step 1:

Remove the cover to access the inner control panel (see page-14 for more information). Rewire jumper as shown on this page on the circuit board marked "TRANSFORMER PRIMARY" (using included jumpers).

### Step 2:

Replace the 3 ampere fuse at the lower left corner of the inner control panel with a 6 ampere fuse from the installation kit. See fuse location in the reference section on page-27.

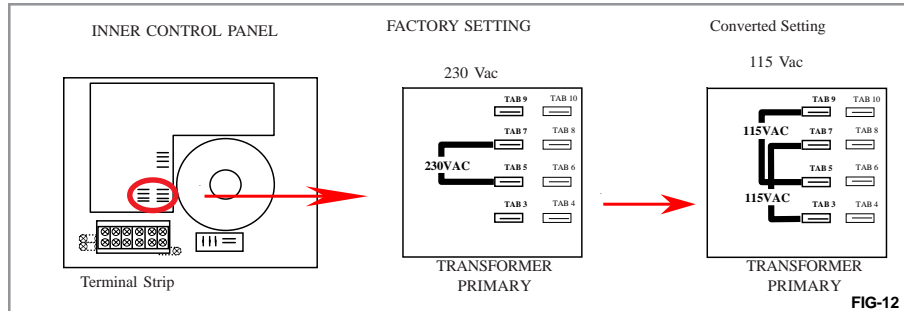

## Connecting DIG-220 to External Equipment:

You must provide the appropriate gauge wire for complete installations to External Time Clock, One-Speed Pump, or Two-Speed Pump connections. Select the diagram that matches your application. (Wiring diagram also located on inside of cover):

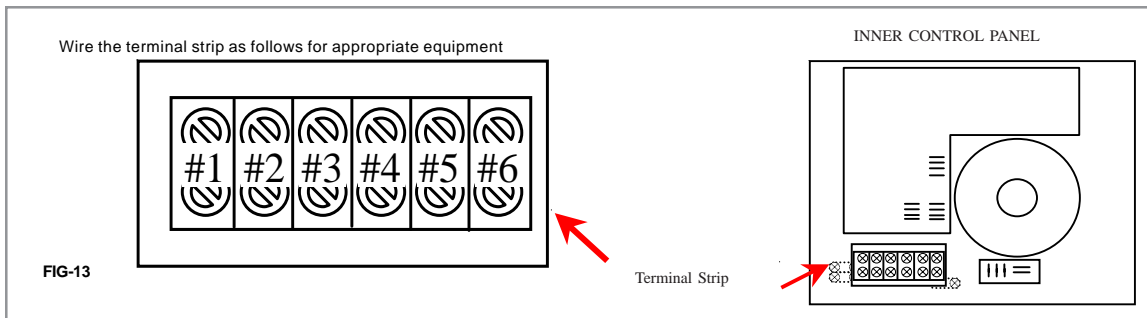

## Connecting DIG-220 to External Time Clock:

### LINE-IN:

1. Remove and discard factory "test" wires from terminals 1, 2, and ground.
2. Connect AC wires from Terminals #1, #2, and ground lug of the DIG-220 to the LOAD SIDE of the time clock, or the same location as the circulation pump wires (pump connected to circuit breaker, time clock or electronic controller).

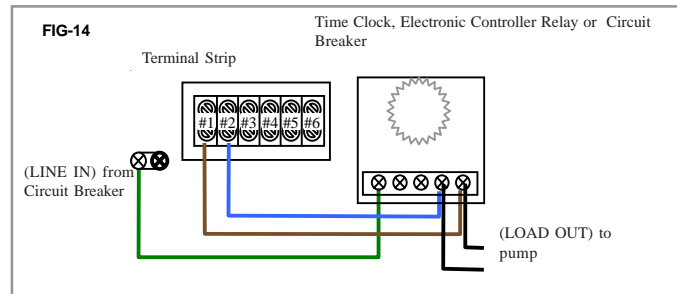

Continued Next Page...



# INSTALLATION (CONTINUED)

## Connecting DIG-220 to Control a One-Speed Pump (with optional pump relay installed)

### LINE-IN:

1. Remove and discard factory "test" wires from terminals 1, 2, and ground.
2. Cut Factory AC wires to 5", strip and expose 1/2" of wire and connect from Terminal #1 to #3, and terminal #2 to #4.
3. Supply new AC LINE-IN wires from circuit breaker to Terminals #3 and #4. Ensure proper gauge wire is used to power the pump.

### LINE-OUT:

Pump is connected to Terminals #5, #6 and Ground lug.

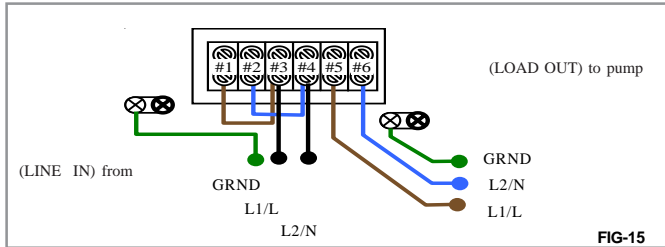

FIG-15

## Connecting DIG-220 to Control a Two-Speed Pump (with optional pump relay installed)

### LINE-IN:

Follow the LINE-IN instructions for the above One-Speed instructions for Two-Speed Pump configuration.

Note: The pump is always powered and will run continuously on low speed when internal time clock program does not have the pump operating on high speed. A safety shut off (wall switch) between the circuit breaker and control box is recommended when the circuit breaker cannot be accessed easily.

### LINE-OUT:

#### Low Speed Wire

1. Remove Factory #6 from the Terminal Strip.
2. Disconnect the other end of the wire from the relay bottom row and reconnect to the relay top row right terminal. Connect the exposed end to the low speed input of the pump.

#### Common Wire

1. Remove the factory #4 wire from the relay.
2. Cut the end off and expose 1/2" of wire. Insert this bare end into the #6 terminal which will create a jumper from #4 to #6.

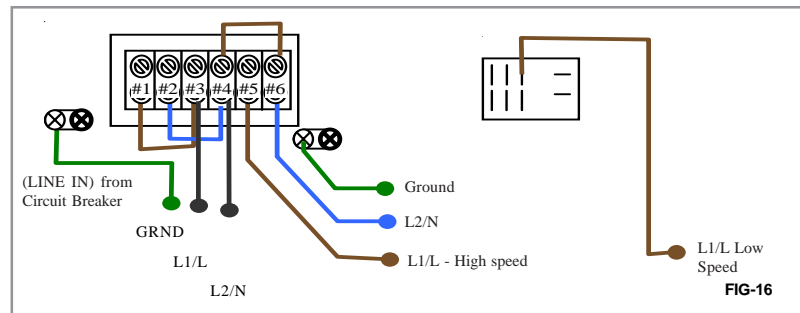

FIG-16

## Cell and Tri-Sensor Cord Connections

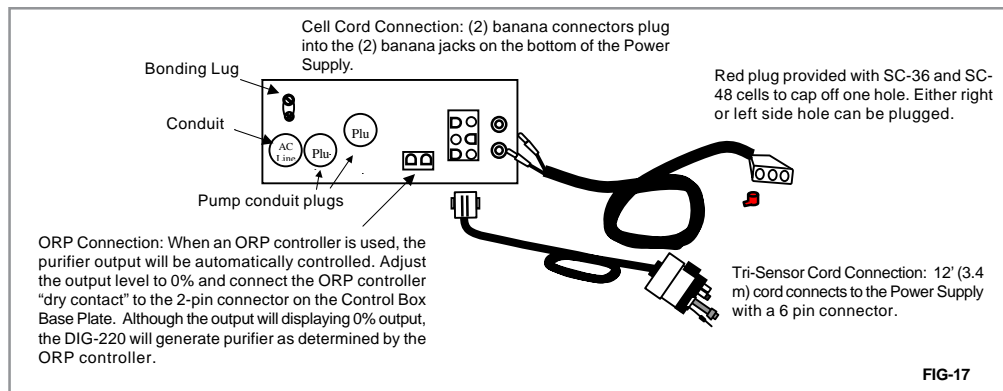

FIG-17

## NOTICE

Failure to heed the following may result in equipment damage.

Do not energize the orp inputs! The orp connections are dry contact inputs.

# PREPARING THE POOL WATER

## Installer Please Note:

When properly sized to the site, the DIG-220 will meet the sanitizer "maintenance" requirements of the pool/spa. The DIG-220 is *not* designed to chlorine shock treat, or build up a chlorine residual, when starting with a zero or very low chlorine level.

Before starting the DIG-220, the water must be properly balanced, and the chlorine level must be adjusted to between 1-to-3 ppm free chlorine. More on adjusting water balance, and start-up chlorine levels, follows below.

## Steps to Prepare Water:

1. Calculate Pool Volume:  
See next section, below.
2. Adjust Water Chemistry:  
(Via saturation index... consider pH, total alkalinity, hardness, and water temperature; also adjust stabilizer level). See Reference section, page-25 & 26.
3. Add Initial Chlorine Dosage:  
Use liquid chlorine (sodium hypochlorite), or available types of tablet or granular chlorine as obtained from pool supply, to achieve 1-3 ppm free chlorine.
4. Add salt to water (test the water for salt level, first).  
Adjust to 3000 ppm. See salt chart on page-24.
5. Enter pool volume information into DIG-220:  
See "Pool Volume" programming on page-22.

## Calculating Pool Volume:

Average Depth =	$\frac{\text{depth of deep end} + \text{depth of shallow end}}{2}$
Gallons (pool size measured in feet)	
Rectangular	= Length x Width x Average Depth x 7.5
Round	= Diameter x Diameter x Average Depth x 5.9
Oval	= Length x Width x Average Depth x 5.9
Liters (pool size measured in meters)	
Rectangular	= Length x Width x Average Depth x 1000
Round	= Diameter x Diameter x Average Depth x 785
Oval	= Length x Width x Average Depth x 785
Calculated pool volume is:	_____
<i>Enter Pool Volume figure in the information section, page-4.</i>	

**FIG-18**

## Adding Salt:

### Type of Salt to Add...

- It is important to use Sodium Chloride (NaCl) salt that is greater than 99% pure.
- Acceptable types of salt include granular food grade, water softener pellets, or solar salt flakes; these are usually available in 25-lb (13 kg) to 80-lb (36 kg) bags at local pool or building supply outlets.
- Water softener and solar salt will have a slower dissolve rate than food grade salt. Rock salt and Granular Salt with Iodine or Rust Preventatives should not be used, as these mixtures contain high levels of impurities and will cause staining.

#### Note:

While not recommended, granular salt containing anti-caking additives such as YPS (Yellow Prussiate of Soda) or Sodium Ferrocyanide *can* be used. However, these mixtures—if not mixed and dissolved immediately—may cause a localized tint to the water or yellow staining of the pool/spa finish.

## Determine Amount of Salt Required (and salt level to maintain)...

*FIRST... Test the water for current salt content !!!*

- The ideal salt range is 3000 - 3500 PPM (2500 minimum) (2.5 - 3.5 g/l). However, if so desired, the DIG-220 *can* operate with salt levels in excess of 35,000 PPM (35.0 g/l).
- Salt levels above 6000 PPM are not normally recommended, as corrosion issues may result. Salt levels below 2400 ppm will reduce the efficiency of the DIG-220 and will result in low chlorine production.
- Extremely low salt levels (below 1900 ppm) will activate the low salt safety cut off, and will halt chlorine production until salt is replenished to proper levels.
- Once the DIG-220 is programmed to the pool water volume, the controller will automatically indicate how much salt is required to attain ideal salt levels. Additionally, please see the reference table, on page-24 for information on amount of salt to be added relative to the gallons of water to be treated vs existing salt level.

## NOTICE

### Failure to heed the following may result in equipment damage.

Do not use a pool cleaner or vacuum head with wheels, as wheels can leave track marks on newly-plastered pools. Do not allow Granular salt to pile up in one location, without brushing, as staining may occur.

## Add Salt to Pool Water...

How to add the salt (or remove it if too much)...

- The object is to have the salt fully dissolve into the water.
- Add salt directly to pool (or spa, if a spa-only installation), and over the main drain (if main drain is present). If there is no main drain, a vacuum head may be used to encourage salt circulation. Start the water circulation pump and set to run continuously for 24 hours to properly dissolve salt.
- Distributing the salt through brushing is also helpful; brush the salt toward the main drain (if one is present). Set pump operation to normal run time after salt has fully dissolved into water.
- If the salt level becomes undesirably high, the only way to remove excess salt is to partially drain the pool/spa and refill with fresh water.

# MENU OVERVIEW

## ACCESS TO PROGRAMMING

### Control Panel:

The following instructions apply to software versions 4.40 and above. Earlier versions of software will vary slightly.

#### The DISPLAY –

After 30 minutes of inactivity, the display will go to a walking dot screen saver mode. All functions such as chlorine generation, reverse, boost, etc., will continue in the background. Pressing any key will call up the normal informational display.

The First line of the display shows the Purifier Output Level in percent (set to 50% at install), or whether the system is in Boost or Super-Boost mode.

The Second line of the display shows the current TIME in either 12 or 24-hr mode, the TEMPERATURE in either Fahrenheit or Celsius, whether the cell is powered or not shown as "ON" or "OFF", and Polarity Direction shown as a "." or blank.

### Operation of Buttons:

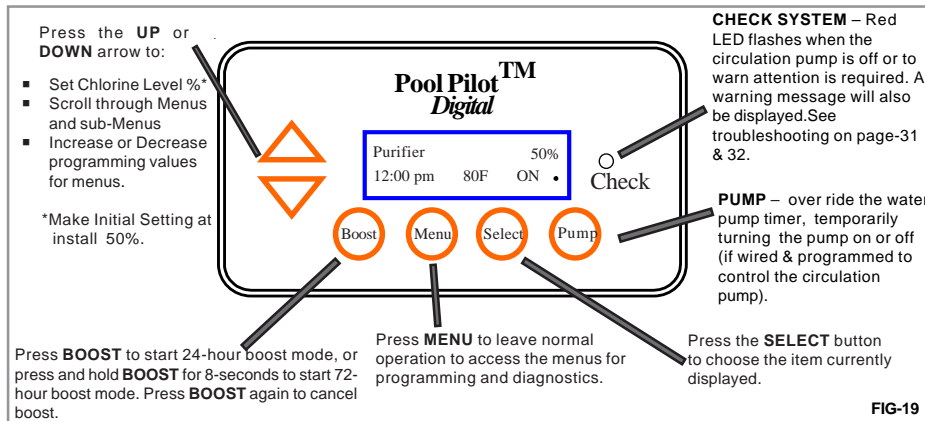

### Menu Button...

The MENU button is used to leave the normal operation mode and enter the program and diagnostic modes. Use the UP/DOWN arrows and SELECT buttons to navigate through the menus and sub-menus.

#### MAIN MENU:

- Test Pool Pilot (R) - displays various operating parameters and diagnostic results
- View Setup - displays the programmed setup parameters
- Owner Options - programs the primary operating parameters an owner would need to change
- Maintenance Menu - tests and programs the primary features a service technician would need to access when servicing the system
- Installer Menu - program the initial system setup

*Note: to permit quick access to features, some functions are accessed or programmed in several menus.*

### Select Button...

The SELECT button chooses the displayed menu option. For the **Installer Menu**, press and hold the SELECT button for approximately 13-seconds to access this feature.

### Pump Button...

(This button is not active if the Pump Configuration is programmed for "External Timer" or "Remote runs pump". If the Pump button is pressed when programmed for one of these modes, "External Time" or "Remote runs pump" will display, then revert back to the normal display.)

#### Pump Button - One-Speed Pump Control

The DIG-220 must be wired to control the main circulation pump and programmed for a One-Speed pump for this feature to be active (for more information on wiring, see page-15 & 16, and for pump control programming, see page-23). Note - optional pump relay must be installed.

- To turn "**PUMP OFF**", when pump is on:
  1. Press Pump.
  2. Press **▽** - Stop Pump will be displayed. Press **▽**
  3. "Pump off" will be displayed.
- To turn "**PUMP OFF FOR SERVICE**", when pump is off:
 

(This mode disables pump operation indefinitely, until manually enabled. Boost and Pump program modes will not enable pump.)

  1. Press Pump.
  2. Press **▽** - Stop Pump will be displayed. Press **▽**
  3. "Pump off for service" will be displayed.
- To **terminate maintenance mode** and return to "PUMP OFF" mode:
  1. Press Pump.
  2. Press **▲** - End Maint.
  3. "Pump off" will be in the displayed.
- To turn "**PUMP ON**", when pump is off:
  1. Press Pump.
  2. Press **▲** - to start pump.
  3. The pump will run until the pump program reaches the next scheduled turn off time.

# PROGRAMMING (CONTINUED)

## Pump Button Continued...

### Pump Button - Two-Speed Pump Control

The DIG-220 must be wired to control the two-speed main circulation pump and programmed for a Two-Speed pump for this feature to be active (for more information on wiring, see page-15 & 16, and for pump control programming, see page-23). The DIG-220 cannot turn off the pump, and can only change pump speeds, between high and low (see "Pump Program 1 and 2" on page-23 for additional information) Note - optional pump relay must be installed.

- To switch to "LOW SPEED" when pump is on high speed:
  1. Press Pump.
  2. Press ▾ Low Speed.
  3. Pump will switch to low speed.
- To switch to "HIGH SPEED" when pump is on low speed:
  1. Press Pump.
  2. Press ▲ High Speed.
  3. Pump will switch to high speed.

## Basic Operational Programming:

### Adjusting the Purifier Output % ...

Press the UP/DOWN arrow buttons to enter the Purifier Adjustment mode. Adjust the purifier output percentage to the desired output: from 0% (off) to 100 % (maximum output); then, press SELECT to default back to the normal display. **At start up of a new system, the standard output setting starting point is 50%.**

Typically, once the initial setting is established, very little adjustment is needed. The purifier % setting refers to the amount of time the cell is energized within a 15-minute cycle. The system cycles on-and-off, as indicated on the display's lower right display.... "ON," when generating chlorine. Higher settings will generate more chlorine.

Follow the instructions "Purifier % Adjustment Procedure" in the chart on page-19 to determine and correct purifier % settings.

Example:

50% setting = 50% of 15-minutes or 7.5-minutes ON and 7.5-minutes OFF.

25% setting = 3.75-min ON, 11.25-min OFF

Once the percentage is set, the DIG-220 will implement the patented temperature compensation algorithm based on current water temperature.

### Boost or SuperBoost...

The Boost feature is used to increase the purifier % from its normal setting to 100% for a cumulative 24-hour or 72-hour period. When the Boost period expires, or is manually terminated, the Purifier % returns to its previous setting and normal operation.

- **Boost Purifier Output to 100% for 24-Hours...** From the normal operation mode, press and release the BOOST button. The display will flash: "Boost 24-hour," then "Boost hh" (with the "hh" actually being the displayed hours remaining in the boost period).
- **Boost Purifier Output to 100% for 72-Hours...** From normal operation mode, press and hold the BOOST button until: "Boost 72 hour ON" is displayed; then release the BOOST button. Display will then show "Boost hh" with the "hh" actually being the displayed hours remaining in boost period.

When Boost is activated, and DIG-220 powered through an external time clock or programmer, the time remaining for the boost cycle is held in memory; Boost will continue when the pump restarts until the 24 or 72-hr boost period has expired.

If the DIG-220 is controlling the pool pump, the Boost will override the pump program and will run continuously at 100% for either 24 or 72 hours.

To exit Boost or SuperBoost mode and revert to normal operation:

- Allow the Boost cycle to expire.
- OR press BOOST at anytime to manually deactivate Boost.

## Purifier Mode

The DIG-220 will automatically display informative messages about the condition of the chlorinator (Purifier Output %, water temperature, warning messages, etc.), and responds to manual adjustment of purifier % setting (as described below). After 30 minutes of inactivity, the display will go to a walking dot screen saver mode. All functions such as chlorine generation, reverse, boost, etc., will continue in the background. Pressing any key will call up the normal informational display.

### Purifier % Adjustment Procedure:

- 1 Balance water chemistry according to necessary water chemistry parameters. (See page-24 & 25.) For new start ups, if free chlorine level as tested is not at least 1 ppm, add liquid chlorine to insure a 1-3 ppm free chlorine reading.
- 2 Add the proper amount of salt as indicated by the DIG-220 (or as described on page-24), and run the circulation pump continuously for 24-hours allowing the salt to be fully mixed and dissolved into the pool. *If the salt level is too low, the DIG-220 will provide a warning, and will not generate chlorine until the minimum salt level has been reached.*
- 3 Use the UP and DOWN arrow buttons to set the purifier % to 50%, and then allow the pool to operate normally.

For the first two weeks, test the water chemistry parameters every 3-4 days. Adjust chemicals as needed to maintain correct water balance. For the Free Chlorine adjustment, use the following table for fine-tuning the controller output percentage (%):

Purifier % Currently set to:	If Free Chlorine is <u>lower</u> than ideal range...	If Free Chlorine is <u>higher</u> than ideal range...
0% - 25%	The purifier % output needs to be increased. Use the up arrow button to increase the purifier output %.	The purifier % output needs to be reduced. - If not done already, set purifier % to lower value. - Power level may be too high and may need to be adjusted down.
25% - 100%	The purifier % output needs to be increased. - If not done already, set purifier % to higher value. - If at 100%, power level may be too low and need to be raised and/or cell size increased. - Check sizing.	The purifier % output needs to be reduced. Use the down arrow button to decrease the purifier output %.

FIG-21

After the optimal output percentage (%) has been determined, this setting will not normally require further adjustment. Rather, to compensate for increased bather usage or heavy rainfalls (which can both quickly consume chlorine), select a Boost Cycle.

# PROGRAMMING (CONTINUED)

Menus:

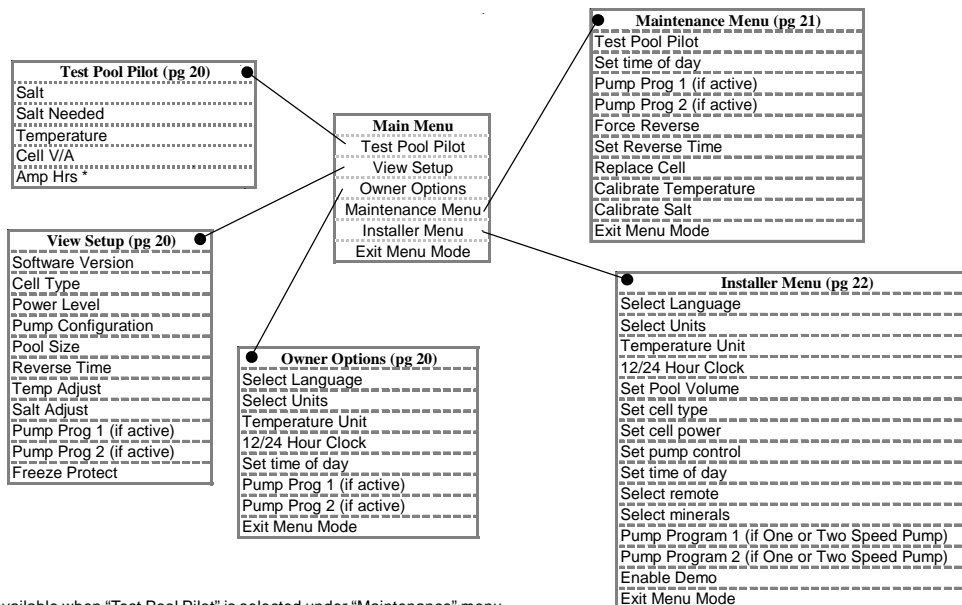

\* Only available when "Test Pool Pilot" is selected under "Maintenance" menu.

## Test Pool Pilot (Diagnostic Menu):

1. Press MENU.
2. "Test Pool Pilot" is automatically displayed; then press SELECT.
3. The display will automatically toggle through the following displays (  $\nabla$  or  $\blacktriangle$  allows manual control forward and back. While in this feature, pressing MENU will override the remaining displays and exit back to normal operation):
  - "Salt =XXXX ppm (X.x g/l)" (The optimum salt level is 3000 ppm (3.0 g/l))
  - "Add Salt xx Lbs (xx Kg)" (The amount of salt needed to maintain 3000 ppm (3.0 g/l))
  - "Temperature XX° F (XX° C)" (The temperature of the water flowing through the Tri-Sensor)
  - "Cell = XX V XX.x A" (The measured voltage and current sent to the SuperCell)
  - "Amp-Hrs = xxxxxx" (The amount of amps received by the SuperCell per hour) . This is only viewable if "Test Pool Pilot" was selected under the "Maintenance Menu."
4. The controller will automatically leave the menu and revert to normal operation.

## View Setup (Program and parameter menu to view the current programmed settings):

1. Press MENU, press  $\nabla$  or  $\blacktriangle$  until "View Setup" is displayed, then press SELECT.
2. The display will automatically toggle through the following displays (or pressing  $\nabla$  or  $\blacktriangle$  allows manual control forward and back. While in this feature, pressing MENU will override the remaining displays and exit back to normal operation):
  - "Software V X.Xx" (The version number of Digital #DIG-200 software)
  - "Cell = XX-XX" (cell type: SC-36, SC-48, SC-60, CC-15)
  - "Power Level" (1-lowest, 2, and 3-highest; factory setting is 2)
  - Pump Configuration (External Timer, one-speed pump, two-speed pump, or remote runs pump. Factory setting is External Timer.)
  - "XX,XXX gallons( liters)" (The pool volume programmed in Installation Menu; 15,000 is the factory setting; page-22)
  - "Reverse = X hrs" (The reverse rate programmed in Installation Menu: 4-hrs is factory setting)
  - "Temp. adjust = X" (The temperature adjustment variation of actual tri-sensor reading; page-22)
  - "Salt adjust  $\pm$  X %" (The salt calibration adjustment variation of actual tri-sensor reading; page-22)
  - "Pump program 1" (Only appears if pump control has been set to one-speed or two-speed)
  - "Pump program 2" (Only appears if pump control has been set to two-speed or two-speed)
  - Freeze protect (can only be enabled when the pump control is set to one-speed pump mode)
3. The DIG-220 will automatically leave the menu and revert to normal operation.

## Owner Options:

1. Press MENU, press  $\nabla$  or  $\blacktriangle$  until "Owner Options" is displayed; then press SELECT.
2. Press  $\nabla$  or  $\blacktriangle$  for desired selections, followed by SELECT
3. Once all modifications are complete, press  $\nabla$  or  $\blacktriangle$  until "Exit Menu Mode" is displayed; then press SELECT. The menu will also time out after 20 seconds of no key activity.

## Select Language:

(Allows for personal preference language display)

1. Press  $\nabla$  or  $\blacktriangle$  until "Select Language" is displayed; then press SELECT (English is the factory setting).
2. Press  $\nabla$  or  $\blacktriangle$  until desired language "English," "Español," "Italiano," or "Français," is displayed; then press SELECT.

Continued Next Page...

# PROGRAMMING (CONTINUED)

## Owner Options Continued:

### Select Units:

(Used to program the operator's personal preferences for the liquid and weights measurement the DIG-220 will display.)

1. Press  $\nabla$  or  $\Delta$  until "Select Units" is displayed; then press SELECT ("English Units" is the factory setting).
2. Press  $\nabla$  or  $\Delta$  until desired measurement "English Units" (gallons and pounds), or "Metric Units" (liters and kilograms), is displayed; then press SELECT.

### Temperature Units:

(Used to set the personal preference (C or F) for temperature display.)

1. Press  $\nabla$  or  $\Delta$  until "Temperature Unit" is displayed; then press SELECT ("Fahrenheit" is the factory setting).
2. Press  $\nabla$  or  $\Delta$  until desired measurement unit "Fahrenheit" or "Celsius" is displayed; then press SELECT.

### 12/24 Hour Clock:

(Allows for personal preference time clock display)

1. Press  $\nabla$  or  $\Delta$  until "12/24 hour clock" is displayed; then press SELECT (12 hour clock is the factory setting).
2. Press  $\nabla$  or  $\Delta$  until the desired clock format (12-hour or 24-hour clock) is displayed, then press SELECT.

### Set Time of Day:

(Allows for changes to the time of day displays for time zones or day-light savings.)

1. Press  $\nabla$  or  $\Delta$  until desired hours are displayed; then press SELECT.
2. Press  $\nabla$  or  $\Delta$  until the desired minutes are displayed; then press SELECT.

### Exit Menu Mode:

Press SELECT to exit menu entry.

## Maintenance Menu:

- Press MENU, press  $\nabla$  or  $\Delta$  until "Maintenance Menu" is displayed; then press SELECT.
- Press  $\nabla$  or  $\Delta$  for desired selections, followed by SELECT
- Once all modifications are complete, press  $\nabla$  or  $\Delta$  until "Exit Menu Mode" is displayed; then press SELECT. The menu will also time out after 20 seconds of no key activity.

## Test Pool Pilot:

(Diagnostic Menu)

The display will automatically toggle through the following displays ( $\nabla$  or  $\Delta$  allows manual control forward and back. While in this feature, pressing MENU will override the remaining displays and exit back to normal operation):

- "Salt = XXXX ppm (X.x g/l)" (The optimum salt level is 3000 ppm (3.0 g/l))
- "Add Salt xx Lbs (xx Kg)" (The amount of salt needed to maintain 3000 ppm (3.0 g/l))
- "Temperature XX° F (XX° C)" (The temperature of the water flowing through the Tri-Sensor)
- "Cell = XX V XX.x A" (The measured voltage and current sent to the SuperCell)
- "Amp-Hrs = xxxxxx" (The amount of current times hours of operation received by the SuperCell) . This is only viewable if "Test Pool Pilot" was selected under the "Maintenance Menu."

### Set Time of Day:

(Allows for changes to the time of day displays for time zones or day-light savings.)

1. Press  $\nabla$  or  $\Delta$  until desired hours are displayed; then press SELECT.
2. Press  $\nabla$  or  $\Delta$  until the desired minutes are displayed; then press SELECT.

### Force Reverse:

Note: this is a diagnostic tool, only, and should not be used unless a problem is suspected.

(This function activates a reverse cycle, which can be used to verify that the self-cleaning feature is working). After selecting "Force Reverse," there will be a 40 second delay before proceeding. During the delay "Cell reversing \*" will display.

1. Press  $\nabla$  or  $\Delta$  until "Force Reverse" is displayed; then press SELECT.
3. "Cell reversing" will display temporarily for 40-seconds.  
The "."(period) on the end of 2<sup>nd</sup> line of the display will either appear, or disappear—based on its previous state—to indicate cell power polarity has reversed.

### Set Reverse Time:

(Used to program the SuperCell's self-cleaning cycle.)

<b>NOTICE</b>	<b>Failure to heed the following may result in equipment damage.</b>
	Reduced polarity reversing cycle times will reduce SuperCell life, and should <u>only</u> be used due to uncontrollable scale formation on the Cell.  <u>ALWAYS</u> test and adjust water balance, <u>before</u> attempting scale control via shortening reverse period.

1. Press  $\nabla$  or  $\Delta$  until "Set Reverse Time" is displayed; then press SELECT (4-hours is the factory setting).
2. Press  $\nabla$  or  $\Delta$  until the desired cycle time (2, 4, 8, or 16 hours) is displayed; then press SELECT.

Continued Next Page...

# PROGRAMMING (CONTINUED)

## Replace Cell:

(Used to reset the ampere-hour counter after a cell is replaced)  
Press and hold for approximately 13 seconds until display briefly shows "Amp-Hrs = 0".

## Calibrating Temperature:

(Used only when it is desired to match the display of the Digital to another on-site thermometer.)

Note: Temperature can only be calibrated 2-minutes after start-up.

1. Press  $\nabla$  or  $\Delta$  until "Calibrate Temp." is displayed; then press SELECT.
2. Press  $\nabla$  or  $\Delta$  to adjust temperature up or down to the desired temperature; then press SELECT. The maximum adjustment is  $\pm 6^{\circ}\text{F}$  ( $\pm 3^{\circ}\text{C}$ ). (To maximize protection, only negative adjustments will be used to calculate freeze protection temperature.)

## Calibrating Salt:

Note: This step is used to match the Digital to the installed Tri-Sensor. In the event the salt display does not match on-site test results, follow these steps (it is necessary to wait 2-minutes after start-up before calibrating salt):

1. Press  $\nabla$  or  $\Delta$  until "Calibrate Salt" is displayed; then press SELECT.
2. Press  $\nabla$  or  $\Delta$  until the number on the display matches the accurately measured pool sample; then press SELECT. The maximum adjustment is  $\pm 1000$  ppm (1.0 g/l).

## Exit Menu Mode:

Press SELECT to exit menu entry.

## Programming at Installation

NOTE: Once determined to be appropriately programmed for the installation site, the following menu items should not require regular access; rather, need to access should be infrequent or not at all. See "Basic Operational Programming," for setting initial Purifier Level and routine control instructions (page-19).

The DIG-220 requires the pool volume be entered into the microprocessor for control center to automatically indicate how many pounds (kgs) of salt to add should salt levels fall. For instructions in calculating volume, see Calculating Pool Volume on page-17.

The salt chart on page-24 can also be used to calculate how much salt, in pounds (kgs), should be added to reach the recommended level of 3000 ppm (3.0 g/l) salinity.

Adjust Purifier Output to 50%... see page-19 for instructions.

## Installer Menu:

- Press MENU, press  $\nabla$  or  $\Delta$  until "Installer Menu" is displayed
- Press and hold the SELECT button for approximately 13-seconds.
- Press  $\nabla$  or  $\Delta$  for desired selections, followed by SELECT
- Once all modifications are complete, press  $\nabla$  or  $\Delta$  until "Exit Menu Mode" is displayed; then press SELECT. Please note - the menu will time out after 20 seconds of no key activity and any changes may be lost.

*To enter the **Installer Menu**, press and hold SELECT button for approximately 13-seconds.*

## Select Language:

(Allows for personal preference language display)

1. Press  $\nabla$  or  $\Delta$  until "Select Language" is displayed; then press SELECT (*English* is the factory setting).
2. Press  $\nabla$  or  $\Delta$  until desired language "English," "Español," "Italiano," or "Français," is displayed; then press SELECT.

## Select Units:

(Used to program the operator's personal preferences for the liquid and weights measurement the DIG-220 will display.)

1. Press  $\nabla$  or  $\Delta$  until "Select Units" is displayed; then press SELECT ("*English Units*" is the factory setting).
2. Press  $\nabla$  or  $\Delta$  until desired measurement "*English Units*" (gallons and pounds), or "*Metric Units*" (liters and kilograms), is displayed; then press SELECT.

## Temperature Units:

(Used to set the personal preference (C or F) for temperature display.)

1. Press  $\nabla$  or  $\Delta$  until "Temperature Unit" is displayed; then press SELECT ("*Fahrenheit*" is the factory setting).
2. Press  $\nabla$  or  $\Delta$  until desired measurement unit "*Fahrenheit*" or "*Celsius*" is displayed; then press SELECT.

## 12/24 Hour Clock:

1. Press  $\nabla$  or  $\Delta$  until "12/24 hour clock" is displayed; then press SELECT (12 hour clock is the factory setting).
2. Press  $\nabla$  or  $\Delta$  until the desired clock format (12-hour or 24-hour clock) is displayed, then press SELECT.

## Pool Volume:

(Must be programmed for the "salt amount needed" display to be accurate.)

1. Press  $\nabla$  or  $\Delta$  until "Set Pool Volume" is displayed; then press SELECT.  
(*Factory setting is 15,000 gallons*). (The range is 500 to 127,500 gallons (1,000 to 226,000 liters))
3. Press  $\nabla$  or  $\Delta$  until correct pool size is displayed; then press SELECT.

Continued Next Page...



# PROGRAMMING (CONTINUED)

## **Cell Type:**

(Must match the installed cell)

1. Press  $\nabla$  or  $\Delta$  until "Set Cell Type" is displayed; then press SELECT (SC-48 is the factory setting).
2. Press  $\nabla$  or  $\Delta$  until the desired cell type (SC-36, SC-48, SC-60, or CC-15) is displayed, then press SELECT.

## **Cell Power:**

(See recommendations on pg 31 for when to change cell power. Factory setting is cell power 2)

1. Press  $\nabla$  or  $\Delta$  until "Set cell power" is displayed; then press SELECT (Power level 1 is the factory setting).
2. Press  $\nabla$  or  $\Delta$  until the desired power level (1, 2, or 3) is displayed; then press SELECT.

## **Pump Control:**

(Program DIG-220 to accept a one-speed pump, two-speed pump, remote, or external timer) Note - optional pump relay must be installed.

1. Press  $\nabla$  or  $\Delta$  until "Set Pump Control" is displayed; then press SELECT (external timer is the factory setting).
2. Press  $\nabla$  or  $\Delta$  until the desired pump configuration (One-speed pump, two-speed pump, remote runs pump or external timer) is displayed; then press SELECT.

## **Set Time of Day:**

(Allows for changes to the time of day displays for time zones or day-light savings.)

1. Press  $\nabla$  or  $\Delta$  until desired hours are displayed; then press SELECT.
2. Press  $\nabla$  or  $\Delta$  until the desired minutes are displayed; then press SELECT.

## **Select Remote:**

(Selects type of external controller. Need Pump control programmed for "remote runs pump" in order to use this option.)

1. Press  $\nabla$  or  $\Delta$  until "Select remote" is displayed, then press SELECT (Remote 1).
2. Press  $\nabla$  or  $\Delta$  until the desired remote (1 or 2) is displayed, then press SELECT.

## **Select Minerals:**

(This is a special display mode, which does not impact salt readings or other functionality)

1. Press  $\nabla$  or  $\Delta$  until "Select minerals" is displayed, then press SELECT (Salt).
2. Press  $\nabla$  or  $\Delta$  until the desired display mode (Salt or Minerals) is displayed; then press SELECT.

## **Pump Program 1 and 2:**

**Note:** The pump programs are only accessible if a one or two speed pump is selected in the pump configuration) There are two programs available for high speed operation. Low speed operation is not programmable and pump will run continuously on low speed unless pump program is calling for high speed. A separate switch is recommended to turn off low speed pump operation when servicing system)

1. Press  $\nabla$  or  $\Delta$  until "Pump program X" is displayed; then press SELECT.
2. Press  $\Delta$  to program the pump, press D to Delete the program or SELECT to exit with no change.  
- If  $\nabla$  is selected, use  $\nabla$  or  $\Delta$  to select hours, then SELECT. Repeat for minutes.

## **Enable Demo:**

(This is a special display mode, which does not impact salt readings or temperature readings. Note that chlorine will not be generated even though valid readings for volts and mps will show on the "Test Pool Pilot" menu.)

1. Press MENU; press  $\nabla$  or  $\Delta$  until "Installer Menu" is displayed; then press SELECT.
2. To disable demo mode, press  $\nabla$  or  $\Delta$  until "Disable demo" is displayed, then press SELECT. Unit will reset and operate in normal mode.
3. To enable demo mode, press  $\nabla$  or  $\Delta$  until "Enable demo" is displayed, then press SELECT.  
\*\*\* DEMO \*\*\* will flash, then DIG-220 will reset into demo mode.

## **Exit Menu Mode**

Press SELECT to exit menu entry.

END OF PROGRAMMING SECTION

# REFERENCE SECTION

## Salt Addition Chart:

The following salt chart is included for reference only; once programmed to the correct water volume, the controller will automatically indicate how much salt is required to achieve optimum water salinity.

To use this chart:

1. Find current salt level (ppm or g/l) in the left column. (This can be obtained from DIG-220 display or by testing water.)
2. Find pool/spa volume in the second row (Gallons or Liters).
3. Find the amount of salt needed to bring pool to the ideal level by finding the intersection of the row and column.

For volumes other than what is shown, use combinations of various columns.

Current salt level ppm (0.0g/l)	Pounds (kilograms) of Salt needed to attain 3000 ppm (3.0 g/l)									
	Pool/Spa Volume in Gallons or Liters									
	1,000 <i>(4,000)</i>	2,000 <i>(8,000)</i>	5,000 <i>(18,000)</i>	10,000 <i>(38,000)</i>	15,000 <i>(56,000)</i>	20,000 <i>(76,000)</i>	25,000 <i>(94,000)</i>	30,000 <i>(114,000)</i>	35,000 <i>(132,000)</i>	40,000 <i>(152,000)</i>
0	25 <i>(11)</i>	50 <i>(23)</i>	125 <i>(57)</i>	250 <i>(114)</i>	376 <i>(170)</i>	501 <i>(227)</i>	626 <i>(284)</i>	751 <i>(341)</i>	876 <i>(398)</i>	1,002 <i>(454)</i>
250 <i>(0.25)</i>	23 <i>(10)</i>	46 <i>(21)</i>	115 <i>(52)</i>	230 <i>(104)</i>	344 <i>(156)</i>	459 <i>(208)</i>	574 <i>(260)</i>	689 <i>(312)</i>	803 <i>(364)</i>	918 <i>(416)</i>
500 <i>(0.50)</i>	21 <i>(9)</i>	42 <i>(19)</i>	104 <i>(47)</i>	209 <i>(95)</i>	313 <i>(142)</i>	417 <i>(189)</i>	522 <i>(237)</i>	626 <i>(284)</i>	730 <i>(331)</i>	835 <i>(379)</i>
750 <i>(0.75)</i>	19 <i>(9)</i>	38 <i>(17)</i>	94 <i>(43)</i>	188 <i>(85)</i>	282 <i>(128)</i>	376 <i>(170)</i>	470 <i>(213)</i>	563 <i>(256)</i>	657 <i>(298)</i>	751 <i>(341)</i>
1,000 <i>(1.0)</i>	17 <i>(8)</i>	33 <i>(15)</i>	83 <i>(38)</i>	167 <i>(76)</i>	250 <i>(114)</i>	334 <i>(151)</i>	417 <i>(189)</i>	501 <i>(227)</i>	584 <i>(265)</i>	668 <i>(303)</i>
1,250 <i>(1.25)</i>	15 <i>(7)</i>	29 <i>(13)</i>	73 <i>(33)</i>	146 <i>(66)</i>	219 <i>(99)</i>	292 <i>(133)</i>	365 <i>(166)</i>	438 <i>(199)</i>	511 <i>(232)</i>	584 <i>(265)</i>
1,500 <i>(1.5)</i>	13 <i>(6)</i>	25 <i>(11)</i>	63 <i>(28)</i>	125 <i>(57)</i>	188 <i>(85)</i>	250 <i>(114)</i>	313 <i>(142)</i>	376 <i>(170)</i>	438 <i>(199)</i>	501 <i>(227)</i>
1,750 <i>(1.75)</i>	10 <i>(5)</i>	21 <i>(9)</i>	52 <i>(24)</i>	104 <i>(47)</i>	157 <i>(71)</i>	209 <i>(95)</i>	261 <i>(118)</i>	313 <i>(142)</i>	365 <i>(166)</i>	417 <i>(189)</i>
2,000 <i>(2.0)</i>	8 <i>(4)</i>	17 <i>(8)</i>	42 <i>(19)</i>	83 <i>(38)</i>	125 <i>(57)</i>	167 <i>(76)</i>	209 <i>(95)</i>	250 <i>(114)</i>	292 <i>(133)</i>	334 <i>(151)</i>
2,250 <i>(2.25)</i>	6 <i>(3)</i>	13 <i>(6)</i>	31 <i>(14)</i>	63 <i>(28)</i>	94 <i>(43)</i>	125 <i>(57)</i>	157 <i>(71)</i>	188 <i>(85)</i>	219 <i>(99)</i>	250 <i>(114)</i>
2,500 <i>(2.5)</i>	4 <i>(2)</i>	8 <i>(4)</i>	21 <i>(9)</i>	42 <i>(19)</i>	63 <i>(28)</i>	83 <i>(38)</i>	104 <i>(47)</i>	125 <i>(57)</i>	146 <i>(66)</i>	167 <i>(76)</i>
3,000	Ideal									
3,500	OK for DIG-220 Operation - (This is typically the maximum salt level desired by most pool owners/operators since most people can taste salt levels above									
Greater than 3,500	OK for DIG-220 Operation but greater than 6000 ppm can cause corrosion to metallic objects (If lower salt level is desired, partially drain and refill with fresh water.)									

## Basic Water Chemistry:

The DIG-220 is designed to produce chlorine on a daily basis. To monitor the system's efficiency, the water chemistry ranges, and schedule of periodic checks—per below—should be followed.

<b>NOTICE</b>	<b>Failure to heed the following may result in equipment damage.</b>
<b>NOTICE</b>	Excessively high chlorine levels can cause premature cell failure and corrosion damage to pool fixtures and equipment.
<b>NOTICE</b>	<b>Failure to heed the following may result in equipment damage.</b>
<b>NOTICE</b>	Always follow the instructions on the manufacturer's label whenever handling or using chemicals.
<b>NOTICE</b>	<b>Failure to heed the following may result in equipment damage.</b>
<b>NOTICE</b>	Do not use a hydrogen peroxide based chlorine neutralizer or permanent damage to the cell will occur.



# REFERENCE SECTION

## Using the Saturation Index (SI) Continued:

Examples:

<p>pH = 7.4 ..... :                  Water Temperature = 84 F ..... :                  Calcium Hardness = 400 ppm ..... :                  Total Alkalinity = 125 ppm ..... :                  Salt Level = 3200 ppm ..... :</p>	<p><b>Water Test Results #1</b></p> <p>pH = 7.4                  TF = 0.7                  CF = 2.2                  AF = 2.1                  SC = 12.4</p>	<p><math>7.4 + 0.7 + 2.2 + 2.1 - 12.4 = 0</math> (Water is perfectly balanced)</p>
<p>pH = 7.8 ..... :                  Water Temperature = 84 F ..... :                  Calcium Hardness = 600 ppm ..... :                  Total Alkalinity = 200 ppm ..... :                  Salt Level = 3200 ppm ..... :</p>	<p><b>Water Test Results #2</b></p> <p>pH = 7.8                  TF = 0.7                  CF = 2.4                  AF = 2.3                  SC = 12.4</p>	<p><math>7.8 + 0.7 + 2.4 + 2.3 - 12.4 = 0.8</math> (Water is scale forming)</p>

**(FIG-24)**

## Part Numbers:

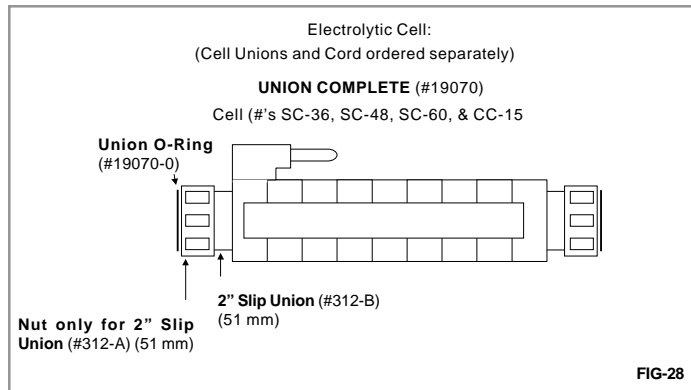
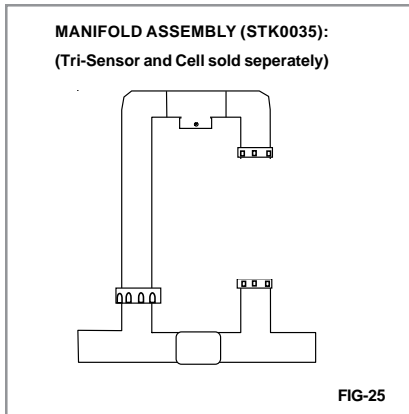
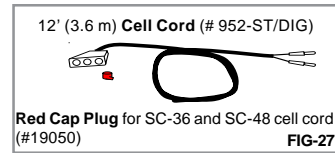
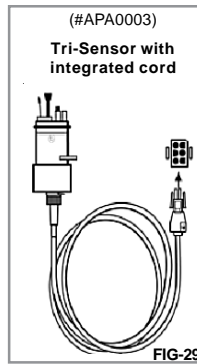
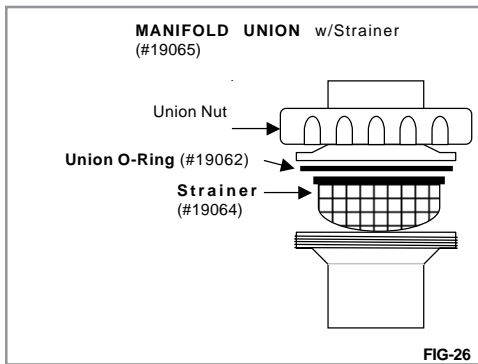

# MAINTENANCE

## Fuse Location and Ratings:

<b>WARNING</b>	<b>Failure to heed the following may result in permanent injury or death.</b>
	<b>ELECTRICAL SHOCK HAZARD...</b> Turn off the electrical power to DIG-220 before servicing.

To inspect or service fuse, disconnect power and remove power center cover (see below for location of fuse). As required, see pages-14 & 15 of this manual for information on converting the DIG-220 from a 230-Vac to 115-Vac input power supply.

Incoming Voltage	Location	Fuse	Description
230V	F1	<b>3 Amps 250 Vac</b>	Main AC Power Fuse
230V	F2	3 Amps 250 Vac	Control Panel
230V	F3	20 Amps 250 Vac	Cell Fuse
115V	F1	<b>6 Amps 250 Vac</b>	Main AC Power Fuse
115V	F2	3 Amps 250 Vac	Control Panel
115V	F3	20 Amps 250 Vac	Cell Fuse

(FIG-31)

There are very few serviceable parts on the DIG-220 except the fuses. For any other problems with the Control Box, please contact the Factory or Authorized Dealer/Service Center. To remove the Control Box Cover and access the fuses, follow these steps.

**DANGER: TURN OFF THE POWER FROM THE CIRCUIT BREAKER BEFORE SERVICING THIS UNIT.**

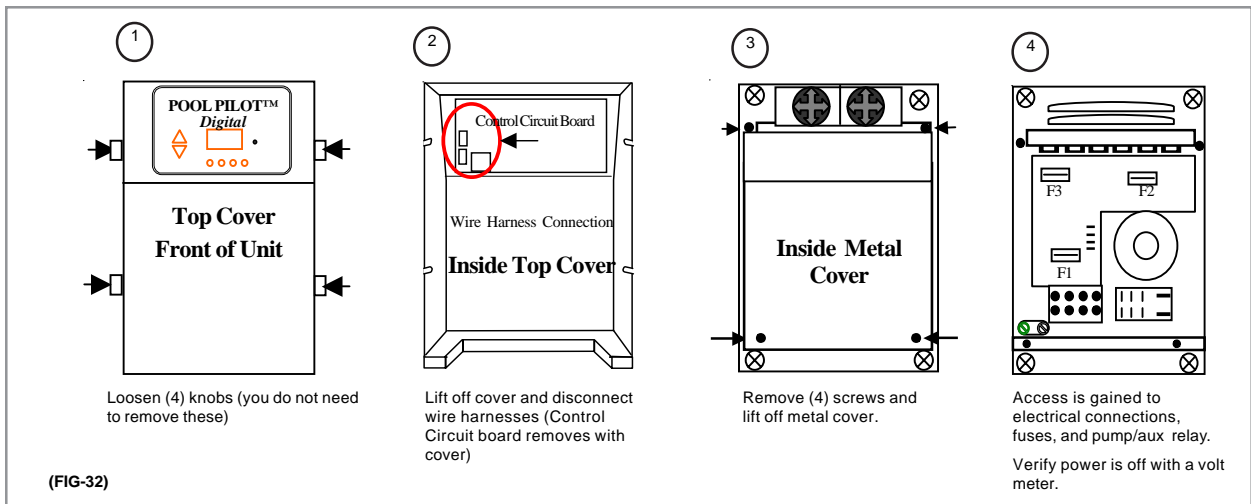

## Removing\Inspecting\Cleaning the Tri-Sensor (Pump must be off):

*Note:* the Tri-Sensor does not normally require maintenance or cleaning. Unnecessary cleaning will decrease the life of the cell.

<b>WARNING</b>	<b>Failure to heed the following may result in permanent injury or death.</b>
	Turn off the pump power at the circuit breaker before servicing this unit. Personal injury or equipment damage could occur if the pump activates.
<b>NOTICE</b>	<b>Failure to heed the following may result in equipment damage.</b>
	If the manifold is located below the water level, be sure to block the flow from both the pool input and output <u>before</u> removing the manifold, tri-sensor, or electrolytic cell.
<b>NOTICE</b>	<b>Failure to heed the following may result in equipment damage.</b>
	The Tri-Sensor should <u>not</u> be pulled out at an angle, or the flow paddle or flow post may be damaged.

Continued Next Page...

# MAINTENANCE

Removing\Inspecting\Cleaning the Tri-Sensor Continued (Pump must be off):

<b>WARNING</b> 	<b>Failure to heed the following may result in permanent injury or death.</b>
	<b>CHEMICAL HAZARD...</b> To avoid damaging splashes, always add acid to water, never water to acid. Wear safety glasses and use other appropriate personal protection equipment.

1. Disconnect the Tri-Sensor cable from the power center. (Place the end of the cable out of the way, where it will stay dry when the Tri-Sensor is removed.) **Please note all cautions and warnings!**
2. Remove the two (2) screws retaining the Tri-Sensor in the Tee joint of the Manifold.
3. Note the orientation of the Directional of Flow Tab. The Tri-Sensor must be installed in the same orientation when it is reinstalled or replaced.
4. The Tri-Sensor can now be pulled out of the Tee. Firmly grip the Tri-Sensor assembly (this is typically done with a large pair of channel lock pliers). Twist the Tri-Sensor back-and-forth while simultaneously pulling the Tri-Sensor straight out of the Tee joint.
5. Inspect the following on the flow switch: Verify the thin metallic paddle is straight and free from erosion; verify the long plastic post is straight and free of cracks. Do not twist or bend the paddle or the plastic post. (see fig 30 on page-26 for illustration of Tri-Sensor flow paddle.)
6. Inspect the two salt sensor blades. The blades should not have any mineral deposits (scale) or other debris on them. If the blades need to be cleaned, use the following method:
  - Do not use any metallic objects to scrape the blade surfaces or you will remove or damage the blade sensor coating.
  - To remove a calcium scale buildup, mix one (1) part Muriatic Acid into four (4) parts water. Mix the solution in a small container tall enough to cover the sensor blades. **Always add acid to water, never water to acid, see warnings above.**
  - Immerse the salt sensor blades in the solution for up to 15-minutes. An effervescing action indicates the calcium is being dissolved from the blades.
  - Rinse with fresh water and reinspect. Repeat the acid treatment as necessary until all scale has been eliminated. Use care not to allow the pin connection to get wet.
7. Check the tri-sensor assembly for any damage to the plastic housing and replace if needed.

## Testing the Flow Switch, Cleaning the Filter Screen, Cleaning the Bypass Valve

The flow switch is a critical equipment protection device. When water flow has stopped, to prevent damage to the cell or system, it is important power to the SuperCell be automatically turned OFF. It is important to verify the proper operation of the Tri-Sensor's water Flow Switch protection device.

<b>NOTICE</b>	<b>Failure to heed the following may result in equipment damage.</b>
	<b>DO NOT</b> operate system with a faulty flow switch.

The following procedure can be used to verify the proper operation of the flow switch, or to flush debris from the Bypass Valve.

1. Turn off circulator pump.
2. Slightly loosen the union nut just below the cell on the side of the manifold that does not contain the filter screen.
3. Completely loosen the manifold union nut that contains the filter screen and pivot the manifold to gain access to the filter screen.
4. Remove the screen. Clean the screen if dirty.
5. If the screen was dirty, then the system may need to be purged to remove excess debris. Leave the manifold off and run the pump for a few seconds until clear.
6. Wrap the strainer screen securely with a small piece of plastic wrap (saran wrap, food wrap or zip lock bag) as indicated in the diagram, place it back in the union.
7. Hand tighten the two unions that were loosened.
8. Turn on the pump and the DIG-220. The plastic will stop water flow to the flow switch, which is part of the Tri-Sensor that is located in the upper portion of the manifold. All water will be forced through the Bypass Valve. This action will normally flush out any small bits of debris trapped in the Bypass Valve.)
9. The DIG-220 should detect a low water flow at the Tri-Sensor, and activate the red Check System LED. The DIG-220 will also display the message "Purifier Off! Check Flow."
10. If the DIG-220 did not display this warning, then check the Tri-Sensor cable connections and inspect the Tri-Sensor as outlined in the previous section. If the warning message still does not appear, then turn the DIG-220 off and contact the factory or your local dealer for assistance.
11. Turn the pump off.
12. Loosen the unions.
13. Remove the plastic wrap and replace the strainer screen. Hand tighten unions.
14. Resume normal operation.

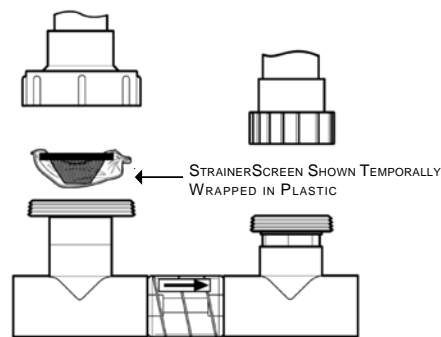

FIG-33

## Servicing the SuperCell

The SuperCell may require removal for periodic visual inspections, or for servicing when debris or calcium mineral deposits develop. The need to inspect and service the cell is indicated by the following display messages: "Check System" light, and the message, "Check/Clean Cell", or "Purifier Off - Check Flow".

The SuperCell is installed with Unions on each end to allow quick and easy installation and removal.

1. Turn off pump and shut off all power.
2. Detach the SuperCell cable from the SuperCell.
3. Unscrew the unions at both ends of the SuperCell.
4. Slide the SuperCell out of the Manifold Assembly.

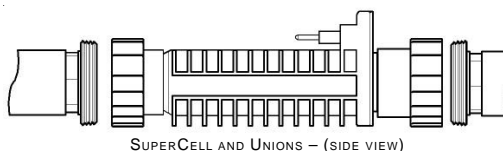

FIG-34

# MAINTENANCE

## Servicing the SuperCell (Continued)

### Visual Inspection of the SuperCell...

Remove the SuperCell from the Manifold Assembly, following the directions in the previous section. The SuperCell titanium blades, seen inside the cell body, should be straight and clear of any debris on the ends or between the blades.

A white flaky or crusty calcium build up on the edge or between the blades will shorten the life of the cell.

Clean the cell immediately, and determine the cause of scaling. See "Basic Water Chemistry," and "Using the Saturation Index" ... on page-24, 25, & 26. Also see "Manual Cleaning of the SuperCell" ... starting on this page. Your DIG-220 is designed to automatically self-clean calcium scale build up that may form on the blades during normal operation. However, unbalanced water chemistry can cause a heavy scale build up exceeding self-cleaning capabilities... thus; periodic manual cleaning may be necessary. The simplest way to avoid this extra work is to maintain the water chemistry at the levels recommended.

END VIEW OF THE SUPERCELL LOOKING AT THE BLADES

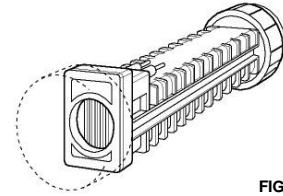

FIG-35

<b>NOTICE</b>	<b>Failure to heed the following may result in equipment damage.</b>
	For maximum cell life, maintain water in a balanced condition. Water maintained in a scaling condition will shorten cell life and may render the chlorinator inoperative. Damage and/or service calls, caused by improper water balance, will NOT be covered under the equipment warranty.

### Manual Cleaning of the SuperCell...

<b>NOTICE</b>	<b>Failure to heed the following may result in equipment damage.</b>
	Scraping or scratching the titanium blade's edge or surface <b>will</b> damage the blade catalyst coating and cause premature failure of the cell... warranty will be voided. <u>Never</u> use any sharp or metallic objects to remove scale.

<b>WARNING</b>	<b>Failure to heed the following may result in permanent injury or death.</b>
	<b>CHEMICAL HAZARD...</b> To avoid damaging splashes, always add acid to water, never water to acid. Wear safety glasses and use other appropriate personal protection equipment.

The SuperCell should only be cleaned when excessive calcium buildup is present. Unnecessary cleaning will reduce the life of the cell.

1. Turn off circulator pump.
2. Loosen the unions as indicated on the cell manifold.
3. Remove the cell and place a cap or plug on the end of the cell as shown. Plugs are available at any pool supply warehouse or home improvement store. Ask for a 1.5" MPT clean out plug.
4. Fill the capped cell with water 2-inches from the top of the cell blades.
5. Fill the rest of the cell with Muriatic Acid. This allows for an approximate 1-to-4 solution. Always add the acid to the water. If you do it the other way around, it can cause the solution to spray back at you causing serious injury.
6. Allow the solution to sit in the cell for up to 20-minutes.
7. Safely dispose of the solution; pouring it into the pool is recommended.

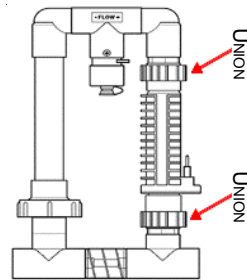

FIG-36

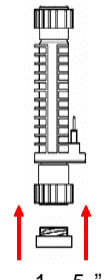

FIG-37

### Installing a SuperCell...

1. Clean and dry the electrical terminals on the SuperCell. The contacts must be completely dry to avoid corrosion and failure of the SuperCell or cable.
2. Insure the union o-rings are firmly in place; then place the SuperCell into the manifold with the cell oriented as illustrated in the diagram on page-12.
3. Tighten the unions by hand for a watertight seal.
4. The SC-36 and SC-48 SuperCell will have two (2) electrical terminals. The SC-60 and CC-15 will have three terminals
5. Connect the SuperCell plug cord so two (2) open holes align with any two mating terminals and push gently, but firmly, to connect. if using a SC-36 or SC-48 Cell, use the red weather plug to seal the unused contact in the cable.
6. Turn on the system.
7. Check for leaks and proper operation of the chlorinator.



# MAINTENANCE

## Important

### Information Critical to the Survival of Your Chlorinator

#### Winterizing

In areas that experience severe cold weather, or extended periods of freezing temperatures, the DIG-220 should be winterized by draining all water from the Manifold Assembly (SuperCell and Tri-Sensor), pump, filter, supply and return lines prior to freezing weather, the Digital Manifold (including the SuperCell and Tri-Sensor) will be damaged by freezing water. The DIG-220 power supply is not affected by the cold and does not need to be removed.

#### NOTICE

Failure to heed the following may result in equipment damage.

Special measures are required in the event of freezing conditions. Your DIG-220 may be damaged if measures are not taken in advance of freezing conditions. Equipment damage due to freezing conditions is NOT covered under the equipment warranty.

#### *Freeze protection program and its limits*

When configured to control the circulation pump, the DIG-220 can reduce the possibility of freeze damage to the filter and pipes in milder climates where freezing weather is not normally expected. Winterizing procedures should be done prior to periods of freezing temperatures.

The DIG-220 will turn on the pump and circulate pool water while the water temperature is below 40°F (4.4°C). Circulating the pool water will reduce the possibility of damage to the filter and pipes due to freezing.

The DIG-220 freeze protect feature will NOT work properly unless all of the following conditions are met:

- The DIG-220 must be powered continuously. An external switch or timer should not be used to turn off the DIG-220 power during the freezing weather.
- The DIG-220 must control the power to the circulation pump.
- The DIG-220 "Pump Control" must be programmed for One-speed pump (see pg. 34). When the Tri-Sensor indicates that water temperature is below 38°F (4.4°C), the Control Unit will override the normal timed program cycle and run the pump 30 minutes minimum or continuously while the water temperature is below 38°F (4.4°C).
- The DIG-220 uses a temperature sensor located in the Tri-Sensor to determine water temperature. If the Tri-Sensor is located so that it cannot accurately detect the cold water, then the freeze protection becomes ineffective. (For example, if the Tri-Sensor is located inside a protected or warm location and the other pool components are located in an unprotected area, the other pool components could freeze before the Tri-Sensor detects the cold water.)

#### Spring Start-Up

It is recommended the water be manually chlorine-shocked when first starting up the pool in the springtime. Test water, and add the appropriate chemicals to balance the pool water per the levels recommended on page-24 & 25.

Be sure to check salt and cyanuric acid (stabilizer), bringing those readings up to the recommended levels. It is also a good idea to inspect the cell, manifold screen, and test the Tri-Sensor flow switch; clean and/or replace those items as necessary.

# TROUBLESHOOTING

Issue / Message Displayed	Problem	Typical Solution
1) Insufficient Purifier Production.	The test kit reagents or test strips are old or expired.	Retest with new Reagents or Strips.
	The DIG-220 is set too low in relation to purifier demand.	Increase the Purifier % output.
	The circulation run time is insufficient.	Increase your pump run time.
	The bather load has increased.	Increase the Purifier % output or add a Non-Chlorine Shock containing Potassium Monopersulfate to supplement.
	The body of water being purified leaks.	Repair the leak and rebalance as needed.
	Low Salt.	Check the residual salt level and adjust as needed.
	"Cell Type" selection not matched to the cell installed.	Follow the INSTALLER SETUP instructions, see page 23.
	Purifier loss due to intense sunlight.	Check your stabilizer level and adjust if needed.
	If the output is 100% then "Cell Power" may be inadequate.	Follow programming directions on page 23 to increase the power level.
2) Scale Buildup within the Cell.	The water being purified contains high pH, total alkalinity and calcium hardness levels. (Cell scales within 2 – 3 weeks)	Calculate Saturation Index to assure balanced water. Adjust chemicals and clean the cell. See page-24 & 25 and page-28 & 29.
	Power Supply not reversing polarity. (Cell constantly scales within 3 – 5 days)	Contact the factory for Warranty Status/Procedures.
3) DC Plug and Cell Terminals Burned.	The Cell terminals are wet due to an incorrectly oriented (upside down) cell, failure to dry terminals, or leaking cell body.	Make sure cell is installed correctly. See page- 29. Contact the factory for Warranty Status/Procedures.
	The Cell plug is not securely pushed onto the cell terminals, causing electrical arcing in the cell cord terminals.	Ensure the Cell cord plug is pressed completely onto the Cell terminal. Check the terminals and clean with a dry cloth to remove all dirt and corrosion. If the cell cord is corroded or burned then it must be replaced to prevent damage to the cell.
4) Premature Cell Failure (Requires Replacement Cell).	Abnormally high Cell usage due to an insufficient Stabilizer (Cyanuric acid) level.	Check the stabilizer level and adjust to recommended levels.
	Excessive Scale/Debris in the Cell.	See Section 2 above.
	"Cell Type" selection not matched to the Cell installed.	Follow the INSTALLER SETUP instructions, see page-29.
5) White Flakes in the Water.	This occurs when excessive calcium hardness is present. Usually due to water chemistry imbalance	Adjust your water chemistry, visually inspect Cell for scale buildup and if necessary clean the cell as described on page-29.
6) No Power to the Control Box.	Circuit Breaker tripped.	Check the power going to the Control Box. Reset the Circuit Breaker.
	Internal Power Fuse blown.	Check and replace fuse. See page-27.
7) CHECK SYSTEM Light Flashing. Message Displayed "PURIFIER OFF - CHECK FLOW" (No purifier generation during this display)	Insufficient Flow (Min 15 gpm) (3.4 m <sup>3</sup> /hr)	Ensure your Filter and Cell are clean of debris. Check all valves that might divert flow away from the cell.
	Tri-Sensor Defective.	Contact the factory for Warranty Status/Procedures.
	Tri-Sensor Cord Defective.	Contact the factory for Warranty Status/Procedures.
8) CHECK SYSTEM Light Flashing. Message Displayed "CHECK/CLEAN CELL" (Purifier still producing)	Extremely Low Cell Amperage. Select "Test Pool Pilot" menu and note cell volts and amps.	Same as LOW SALT message below.
9) CHECK SYSTEM Light Flashing. Message Displayed "LOW AMPS – CELL" (Purifier still producing)	Low Cell Amperage.	Cell heavily scaled. If cell is already clean, replace cell.
	Pool has low salt and the unit needs salt calibration.	Add salt to pool, recalibrate salt sensor.
	The Cell Cord is Loose.	Ensure that the cord is firmly pressed into the cell and the wires properly connected into the banana plugs.
	Power Supply has failed.	Contact the factory for Warranty Status/Procedures.

Continued Next Page...

# TROUBLESHOOTING

Issue / Message Displayed	Problem	Typical Solution
10) CHECK SYSTEM Light Flashing. Message Displayed "PURIFIER OFF - Add Salt xxx lbs (No purifier generation during this display)	Salt level extremely low (below 1900 ppm (2.0 g/l))	Same as LOW SALT message below.
11) CHECK SYSTEM Light Flashing. Message Displayed "Warning! Add Salt XXX lbs (kg)"	Salt level Low (below 2500 ppm (2,5 g/l)).	Add the amount of salt shown on the display. Test the salt level with a reliable salt test kit and compare to the DIG-220 display. Calibrate if needed, see page-22.
12) CHECK SYSTEM Light Flashing. Message Displayed "Freeze Protect"	Pump runs when no program is on.	Freeze protect function is active. See page-30 for description.
13) CHECK SYSTEM Light Flashing. Message Displayed "DEMO" instead of "On" or "Off"	Chlorine is not generated.	Disable demo mode, see page-23.
14) A small dot "walks" across the display.	Display is inactive, but all functions such as purifier are still operational.	Pressing a key will activate the display.
15) CHECK SYSTEM Light Flashing. Message Displayed "Pwr Ctrl Error"		Contact the factory for Warranty Status Procedures.
16) CHECK SYSTEM Light Flashing. Message Displayed "Control Error" (No purifier generation during this display)		Contact the factory for Warranty Status/Procedures.

# APPENDIX

## Declaration of Conformity

(according to ISO/IEC Guide 22 and EN 45014)

**Manufacturer's Name:** Autopilot Systems, Inc.

**Manufacturer's Address:** 2737 24th Street North,  
St. Petersburg,  
Florida USA 33713.

declares that the product:

**Product Name:** Pool Pilot Digital

**Model Number(s):** DIG-220 + SC-36, SC-48, SC-60, CC-15

to which this declaration relates, **meets the essential health and safety requirements** and is in conformity with the relevant EU directives listed below:

**EU EMC Directive 89/392/EEC**

**EU Low Voltage Directive 73/23/EEC**

using the relevant sections of the following EU standards and other normative documents:

EMC: EN55014-1:1993 + A1:1997

EN55014-2:1995

Safety: EN 60335-1:94 + A11:95 + A1:96 + A12:96

Fort Lauderdale, Florida USA

March 7 2002

(Place and date of issue)

Peter Maitland, BSc(Eng), CEng.



## FCC Compliance:

NOTE: This equipment has been tested and found to comply with the limits for a Class B digital device, pursuant to part 15 of the FCC Rules. These limits are designed to provide reasonable protection against harmful interference in a residential installation. This equipment generates, uses and can radiate radio frequency energy and, if not installed and used in accordance with the instructions, may cause harmful interference to radio communications. However, there is no guarantee that interference will not occur in a particular installation.

If this equipment does cause harmful interference to radio or television reception, which can be determined by turning the equipment off and on, the user is encouraged to try to correct the interference by one or more of the following measures:

- Reorient or relocate the receiving antenna.
- Increase the separation between the equipment and receiver.
- Connect the equipment into an outlet on a circuit different from that to which the receiver is connected.
- Consult the dealer or an experienced radio/ TV technician for help.



2737 24th St. North  
St. Petersburg, FL 33713  
1-800-786-7751