

CONVEX Awning Instructions

IMPORTANT NOTE: Please take a few minutes to become familiar with this entire document BEFORE beginning your installation. The time you spend doing this is well spent and will make installing your CONVEX Round Awning quite simple. You will also do it correctly the first time and ensure many, many years of enjoyment.

Basic Tools Needed for Installation

- Tape Measure & Pencil
- Level (Recommended)
- Adjustable Wrench
- Screwdriver
- Drill
- Drill Bits (Depends on Surface)
- Ladder

General Comments

- Wash your hands before installation and be sure they are clean when handling the fabric.
- Always be careful with the fabric during installation. Drills, screwdrivers and other items can puncture the fabric. This and other customer installation damage is not covered by the warranty.
- A second person to assist in holding the awning up and the fabric back when installing your awning is recommended.
- Take your time in planning and installing your new awning. It is very simple to install and the results are excellent, but rushing will make things much harder.

IMPORTANT!

If you need replacement parts or hardware for installation, please do not return your awning to the store or dealer. We will promptly provide these to you at no charge. Call 800-367-3433 ext.278 for assistance.



Planning and Layout of the Installation Location

The first step in installing your CONVEX Round Awning is to determine where you will mount the unit. It should be installed level and centered over the window or door. **If the door or window opens outward, the awning must be high enough to provide clearance when the door or window is in the open position.** (NOTE: In some cities and counties there are building codes that specify how awnings can be mounted.)

Determine where you will be mounting the convex awning and refer to the figure below for typical locations of studs and headers. The framing members outlined in gray will provide an appropriate anchoring point for the fasteners.

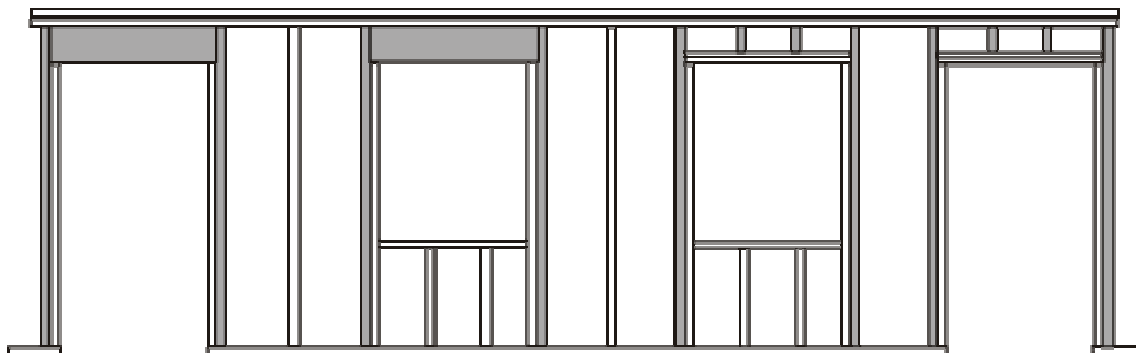

On masonry walls drill and insert appropriate anchors for the mounting screws. For other surfaces, locate the studs for anchoring the supplied screws.

- If the locations of the pre-drilled holes do not match your stud locations, drill new 1/4" holes in the back bar of the frame to match your stud locations.
- If you have planking or another thick surface over the framing, you may need to use longer screws than those supplied to ensure a secure fastening.

Dimensions and List of Parts

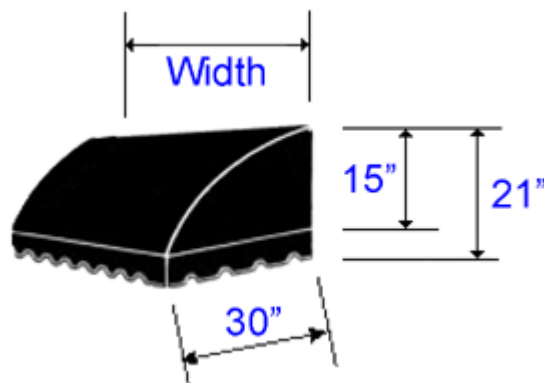

See the list of parts in the figure below. Become familiar with each part before you begin.

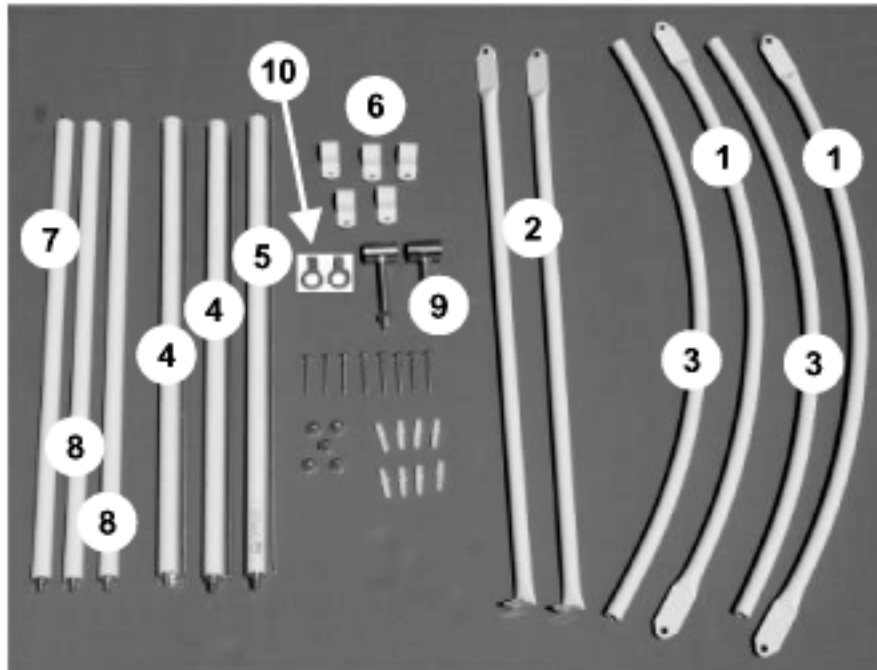

Item	Description
1	Rafter
2	Return Arm
3	Center Brace – 8' to 12' Only
4	Back Bar
5	Back Bar Center – 8' to 12' Only
6	Clamps (Item 11 is shown below)

Item	Description
7	Front Bar Center – 8' to 12' Only
8	Front Bar
9	Rafter Tensioner
10	Rafter Pin
11	Center Return Arm – 8' to 12' Only

Assembled Awning without the Fabric (For reference only, fabric is attached during the installation and the frame is assembled during the installation.)

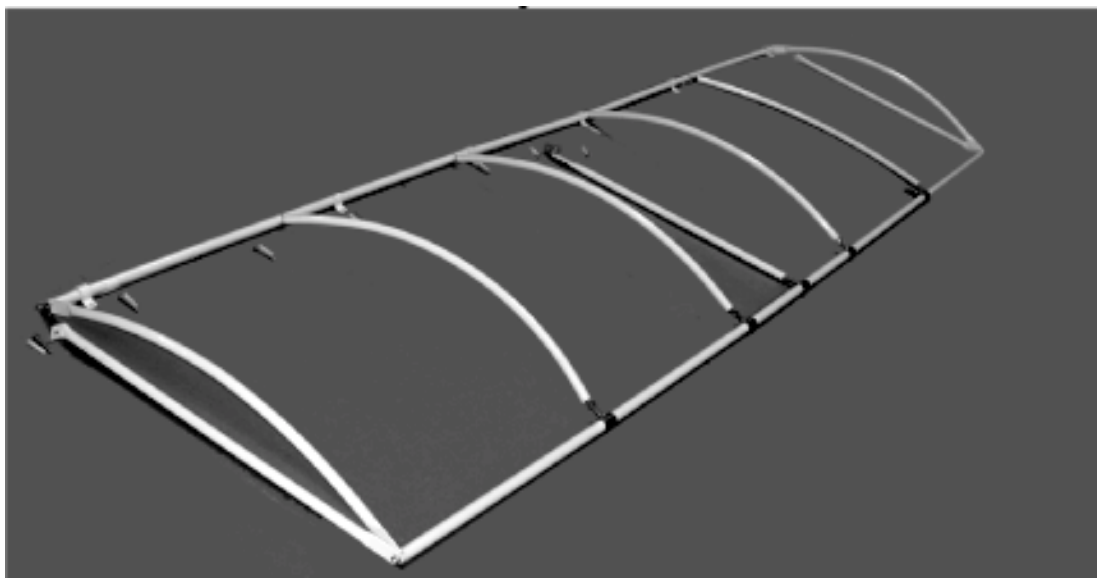

Assembly and Mounting of the CONVEX Round Awning

Assemble the back bar pipes (they are in 2' sections) and include a rafter pin between each section as shown below. Screw together snugly and align the aluminum channel so the fabric can run through the track from one end of the awning to the other.

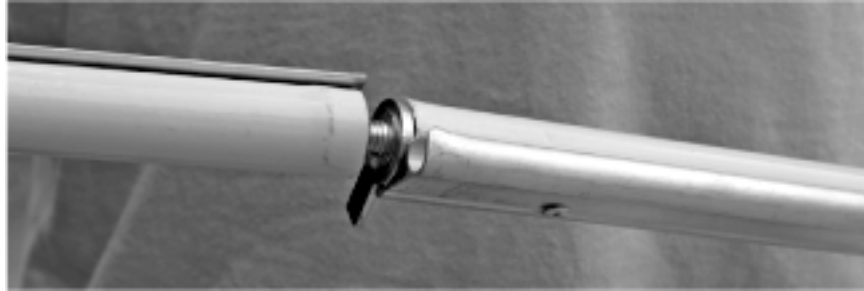

Position the back bar to the correct height above the window or door. Mark the center of the window or door to make sure the awning is centered. For 10' and 12' awnings there is a return arm that should be mounted at least 6 inches below the back bar to keep the front bar level. Attach with clamps and hardware keeping the back bar level.



Ensure the back bar is level and fasten the clamps tightly to the wall.

Review the completed frame assembly as shown below.

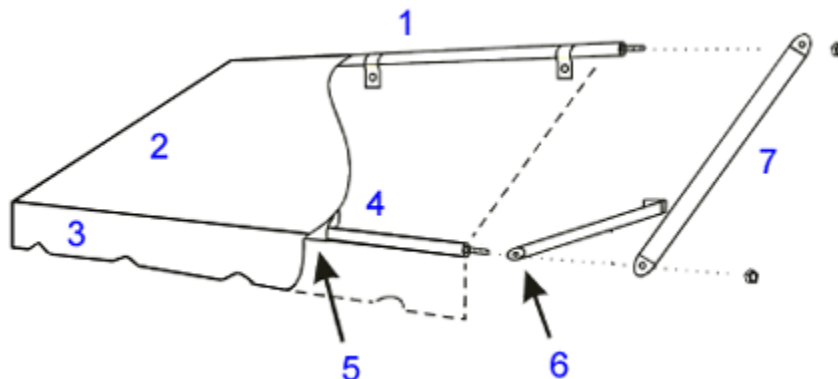

Item	Description
1	Back Bar
2	Cover
3	Valance
4	Front Bar

Item	Description
5	Pocket
6	Return Arm
7	Rafter
8	Center Return Arm (Not Shown)

Slide the rope sewn into the back edge of the cover into the back bar on the wall. You may need to use a screwdriver to slightly open the channel at each section if the fabric catches on the edges.

Assemble the front bar and slide it into the front pocket of the cover. **A rafter tensioner should be installed between each front bar section.** On the 10' to 12' awnings the center return arm will need to be on a center rafter as shown to the left.

NOTE: On the 10' and 12' Wide Quarter Round Awnings there is a center return arm as shown on the left. Make sure the threaded rafter holder is above and the tab with the hole in it is below the front bar when you insert it into the cover.

Hold the front bar out from the wall so the rafter is level to the ground to loosen the fabric. Install a round end rafter (Item 1) connecting the back bar to the front bar. Raising the front bar to the same height as or above the back bar may be required. A second person to hold the front bar out and level may be needed on larger awnings.

Loosely fasten a nut at each end of the back bar to hold the rafter in place.

- **DO NOT TIGHTEN THE NUTS ON THE ENDS OF THE FRONT AND BACK BAR UNTIL THE INSTALLATION IS COMPLETED.**

Repeat the above step for the rafter on the opposite end of the awning.

Slide the return arm into the pocket on the side panel of the awning. Make sure the tab for mounting the return arm to the wall is facing to the inside of the awning. Loosely fasten a nut at the end of the front bar to hold the rafter and return arm in place.

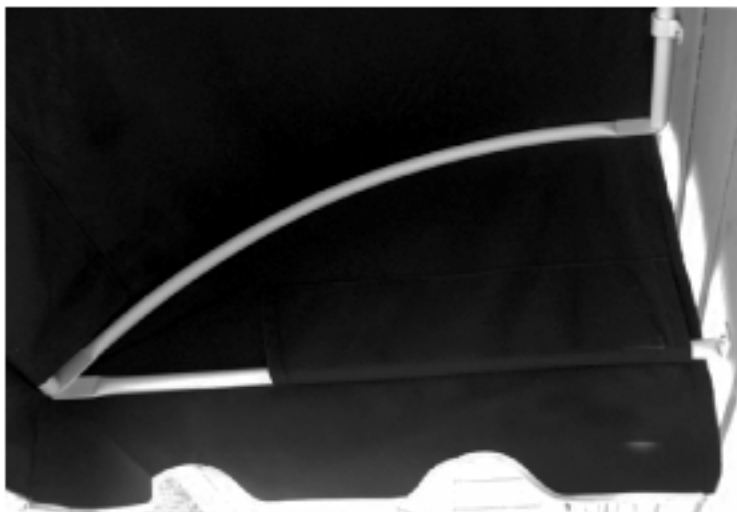

Level the return arms but do not fasten the end of the return arms to the wall until after the center rafters are installed.

Install Center Rafters – First insert one end of the rafter into the rafter pin and rotate the rafter tensioner into the opposite end of the rafter. Snug each bolt by hand to prevent the rafter from coming out.

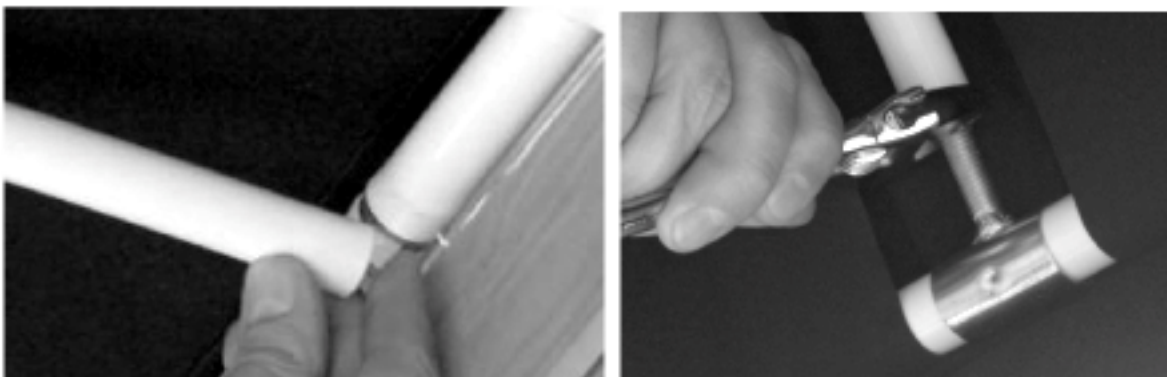

Fasten Return Arms to the Wall - Pull the return arms down firmly to further the fabric before fastening. The last step is to tighten the frame bolts and fabric tensioner bolts to tension the fabric.

Install Center Return Arm – 8’ -12’ CONVEX Round Awning Only: Attached the end of the center rafter to the front bar and the bracket to the rear of the return arm as shown below. You can mount the bracket anywhere 6” below the back bar to 12’ below the front bar but if possible it should be mounted level with the other return arms. Adjust the nut so the center of the front bar is level from side to side.

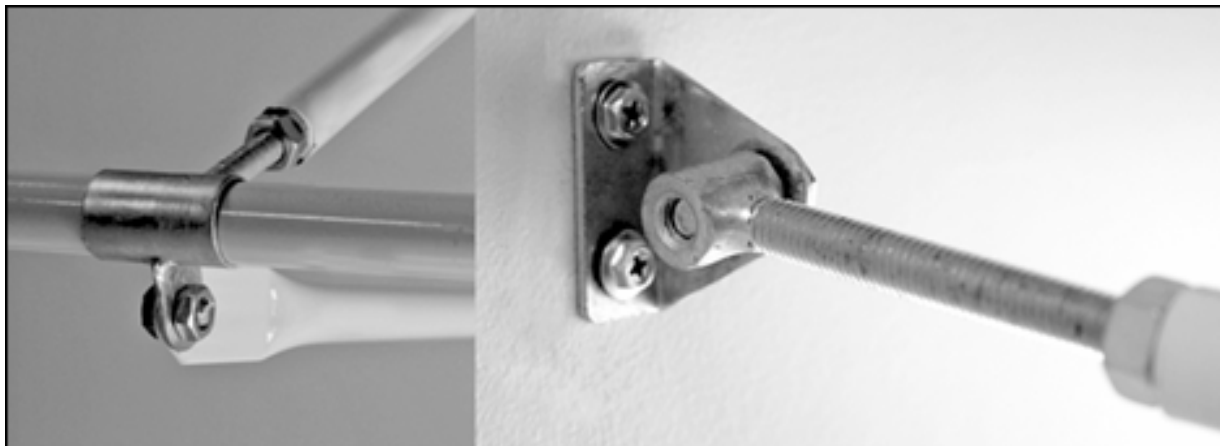

Congratulations - Your Convex Round Awning installation is now complete!

NOTE: If you would like a waterproof seal at the wall, use a non-adhesive caulk to seal the aluminum channel to the wall. This is not recommended if you will be removing the awning each season.

Care and Maintenance

One of the best ways to keep your Convex Round Awning fabric looking great is to hose off the fabric on a monthly basis with water. This will help prevent dirt from embedding in the fabric and reduce the need for thorough cleanings. In most environments, a thorough cleaning will be needed every two to three years with the fabric on the awning frame, or removed for cleaning in your washing machine.

When cleaning your cover on the frame, follow these simple steps:

- Brush off loose dirt.
- Hose down.
- Prepare a cleaning mixture of water and mild, natural soap (NO detergents).
- Use a soft bristle brush to clean.
- Allow soap to soak in.
- Rinse thoroughly.
- Air dry.

If you are removing the cover and using a washing machine, these steps should be followed:

- Use only natural soaps. NO detergent!
- Wash and rinse in cold water.
- Air dry. **NEVER PUT AWNING FABRICS IN YOUR DRYER!**

After a thorough cleaning, the awning fabric should be treated to re-establish water repellency. Your outdoor awning fabric is treated with fluorocarbon-based water repellency chemicals during manufacturing, and it is recommended that a retreatment with ScotchGard® or similar product is done following cleanings.

General Care Tips

- Keep trees and shrubs trimmed back from all canvas awnings.
- Do not use harsh chemicals or bleaches for cleaning.
- Insect repellents and other chemicals can damage the fabric.
- Do not hang from the awning; it will damage the fabric and the frame.
- Remove awnings for painting any mounting surfaces.
- Snow accumulation can stretch or tear the fabric.
- Remove awnings during snow conditions.
- Do not let water "pool" or accumulate on the fabric.

We appreciate your purchase of this CONVEX Awning. We have made every effort to supply a high quality product that insures trouble free service for many years. Please contact us if you have any type of questions, concerns or if we can be of help in any way. If you need replacement parts or hardware for installation, please do not return your awning to the store or dealer. Please contact us at 800-367-3433 extension 278, and we will promptly provide these to you at no charge.