

# Arctic / Vertex

## Aluminum Door Canopy

SHOWN WITH STANDARD SUPPORT ARMS



It is our recommendation that you read instructions carefully prior to assembly and installation

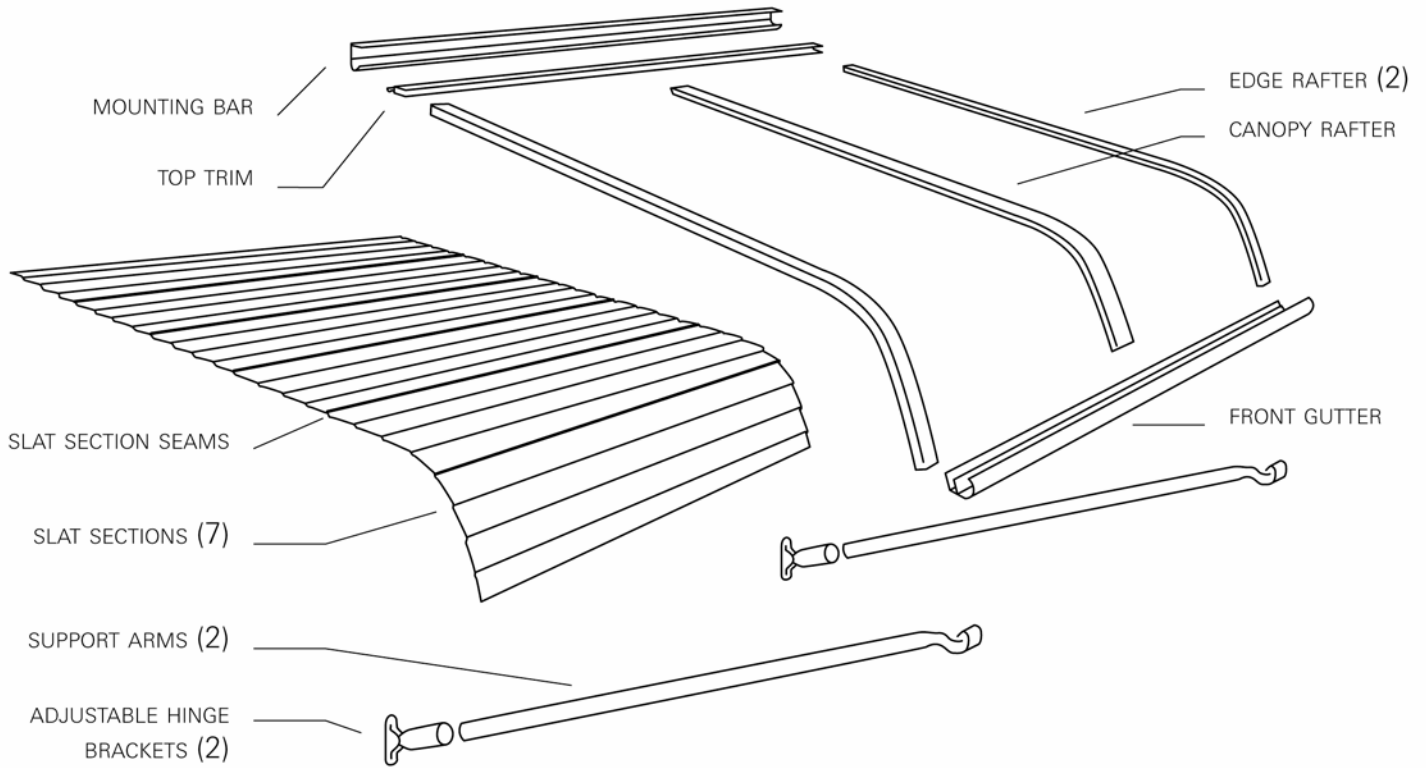

### Arctic / Vertex Metal Awning Parts Check List:

**Note: Take inventory of all parts prior to assembly**

- |                                       |  |  |  |
|---------------------------------------|--|--|--|
| <input type="checkbox"/> Mounting Bar | <input type="checkbox"/> Edge Rafters (2)  | <input type="checkbox"/> Support arms (2)              | <input type="checkbox"/> Small Screws (22) |
| <input type="checkbox"/> Top Trim     | <input type="checkbox"/> Canopy Rafter     | <input type="checkbox"/> Adjustable Hinge Brackets (2) | <input type="checkbox"/> Large Screws (8)  |
| <input type="checkbox"/> Front Gutter | <input type="checkbox"/> Slat Sections (7) | <input type="checkbox"/> Interlock Clips (5)           |  |

**Actual Size End Views** of door canopy parts for easy reference and assembly:



Mounting Bar



Top Trim



Front Gutter



Edge Rafter



Canopy Rafter

### Required Tools:

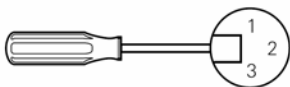

Phillips, Regular & Hex head  
Screw Drivers or Bits



Channel Lock Pliers

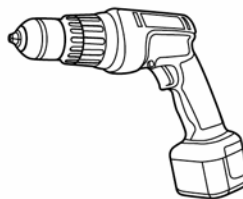

Power Drill

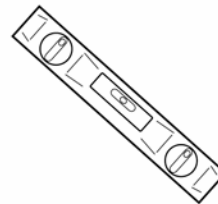

Level

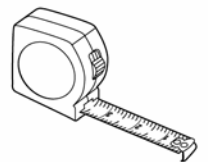

Tape Measure

# Assembly Instructions

## Arctic / Vertex Metal Door Awning

1

Slats have a slight curve to them. Keep them this way for assembly.

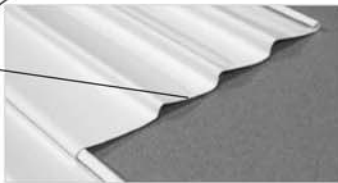
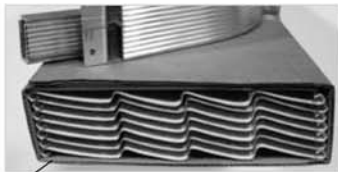

1

1a

It is important that the **Canopy Slats** are assembled properly so that rain water will not leak through the seams where the slats join.

**The canopy is assembled upside down.** Note that the **Slat Sections** are packaged upside down. (see detail 1) Assemble on a flat surface.

**Caution:** Canopy parts may have sharp edges. Use care in assembly.

Begin by laying the first slat out, curled edge **DOWN** on your left with ends toward you. Slide each subsequent slat into the curled **UP** edge on the right. Be sure the slats interlock properly. (see detail 1a)

When all slats are interlocked together the Slat Section of the Canopy is ready for the next step.

2



While keeping Slat Sections **flush with each other**, crimp slats together at each seam interlock with a pair of channel lock pliers about 1/4 inch in from the edge (not too much - only enough to secure them together). Be sure to keep the plier teeth level with slats as to not accidentally bend them up while crimping.

3

Top Trim

Curl Down

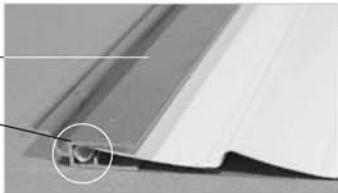

Slide the **Top Trim** onto Slat Section end with **curl DOWN** on the left with the pre-punched holes of the Top Trim **UP**.

4

Front Gutter

Curl Up

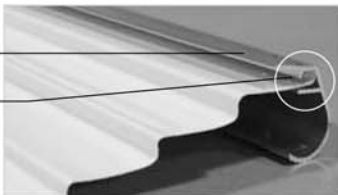

At the right end or end with the **curl UP**, slide the **Front Gutter** onto Slat Section, be sure to slide the Slat Sections correctly into the channel of the Front Gutter as shown. Make sure the pre-punched holes of the Front Gutter are **UP**.

5

Edge Rafter

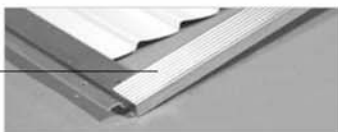

**TIP:** use the palm of your hand flat on slats pulling toward you to help snug them into edge rafter.

Slide the **Top Trim** out from Slat Section about 2 inches to provide clearance. Next slide the none curved end of the **Edge Rafter** onto Top Trim, making sure the opposite curved end of the Edge Rafter is up.

Next slide both Top Trim and Edge Rafter back toward Slat Section and push Edge Rafter onto slat section edge evenly until slat section & the Top Trim are completely **FLUSH** into Edge Rafter.

6

Front Gutter

Edge Rafter

Illustrated to show assembly -



**NOTE:** it is very important that both ends; the top trim and the front gutter ends along with the slat section are completely flush in the edge rafter to be able to align pre-punched holes for assembly

Now connect the **Edge Rafter** and Slat Section with the **Front Gutter**. Again, Slat Section and Front Gutter **MUST** be **FLUSH** in the Edge Rafter.

With Slat Section still secured **FLUSH** in Edge Rafter slide Front Gutter toward you and flush into the Edge Rafter, aligning pre-punched holes, it will fit snug.

**Note:** Only the outside edge of the Front Gutter and the curled edge of the slat is inserted into the Edge Rafter, as shown in fig. 6.

Next, secure **Edge Rafter** in place. Secure Top Trim and Front Gutter with small screws in the larger pre-punched holes at **each end** of the Edge Rafter.

7



Next fasten small screws in the **two** larger pre-punched holes along Edge Rafter. (Pairs of **small holes** are for optional sidewings connections)

**Note:** Support the underside of the Slats Section and apply pressure while fastening screws

**Repeat Edge Rafter assembly on the other side.**

**8**

Top Trim  
Canopy Rafter

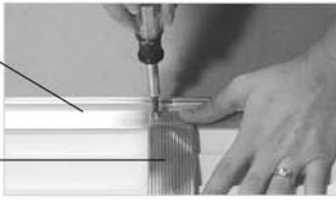

Now install **Canopy Rafter**.

Align Canopy Rafter with pre-punched holes in the center of the Top Trim first and secure with small screws, then do the same at the other end of the Canopy Rafter in the center on the Front Gutter and secure with small screws.

**9**

Interlock Clip

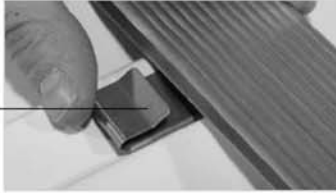

Next install **Interlock Clips**.

Connect Canopy Slat Section to the **canopy rafter** using interlock clips at each joint **where the slats interlock**. Installing clips is a two-step process: first insert the curved part of clip into slat joint, then slide clip onto Canopy Rafter. Interlock clips are installed on the flat section of the awning only, not at the curve. If stubborn, make sure they are straight and parallel with the slat joint.

## Installation Instructions with Support Arms

(Awnings ordered with Support Arms do not include Sidewings, however Sidewings can be ordered separately)

**1**

Caulk  
Mounting Bar  
6 inch minimum

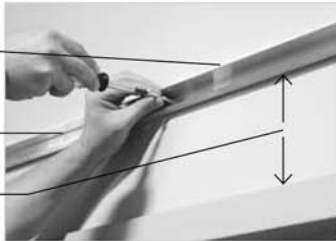

Install **Mounting Bar** and secure with large screws above the door. Models with standard Support Arms require a minimum of 6 inches above door.

Be sure the Mounting Bar is level and centered over the opening. Screws must be in studs or heavy sheathing. (Drill alternate holes in bar if necessary)

**!** *Caulk the top of the Mounting Bar against the house.*

**Note:** Models with **Sidewings** require 13 inches for standard sidewings and 6 inches for special ordered **Low Mount Sidewings**.

**2**

Adjustable Hinge Bracket  
Arm  
Front Gutter

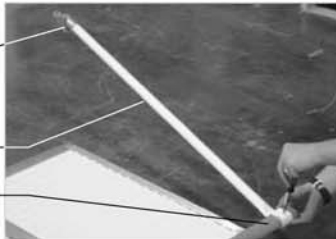

Attach **Support Arms** on Front Gutter with small screws. Install **Adjustable Hinge Brackets** to opposite ends of support arms and **hand** tighten set screws. The Adjustable Hinge Brackets will need re-adjusting and leveling when fastening to the house.

**Note:** For models with **Sidewings**, please see instructions on back.

**3**

Mounting Bar  
Top Trim Inserted  
Small Screws



Align the front of the Canopy above the **Mounting Bar** and insert the **Top Trim** into the Mounting Bar (allow **Support Arms** to rest on the house). Align holes and secure Top Trim to Mounting Bar with small screws from bottom side, as shown.

**!** *Apply a bead of caulking in the trough of the mounting bar prior to installation of the awning's top trim placement onto*

**4**

Adjustable Hinge Bracket

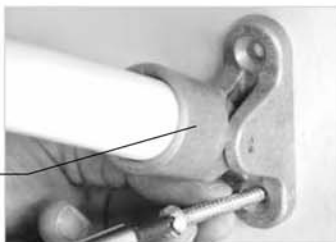

Adjust Support Arms for desired pitch. Be sure door opens completely before attaching.

Align **Adjustable Hinge Brackets**, level and secure to wall with large screws.

Tighten set screws on brackets.

Installation is now complete.

# Installation Instructions with Sidewings



1

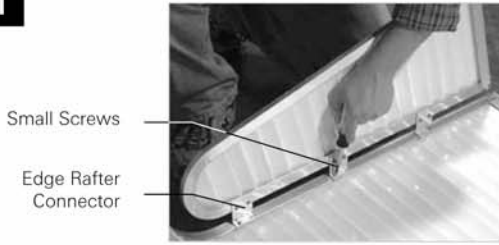

If using **Sidewings**, attach sides to **Edge Rafter** with small screws using pre-drilled holes.

**Please note:** Support Arms are included on awnings in excess of 84 inches wide. Support Arms may still be used when Sidewings are attached for additional support.

2

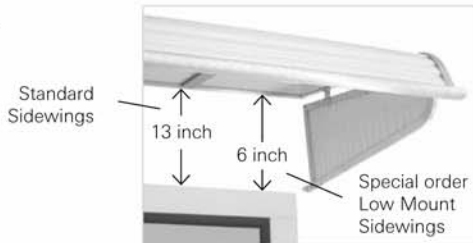

Install **Mounting Bar** with large screws above the door.

Be sure the Mounting Bar is level and centered over the opening. Screws must be in studs or heavy sheathing. (Drill alternate holes in bar if necessary).

 Caulk the top of the Mounting Bar against the house.

**Note:** **Sidewings** require 13 inches of headroom over door for mounting. Specially ordered **Low Mount Sidewings** require 6 inches of headroom for mounting.

3

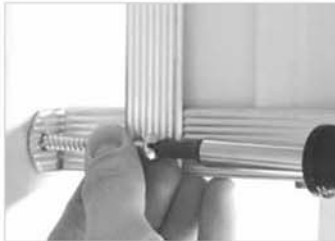

Adjust Sidewings so they are vertically plumb. Attach Sidewings to house with large screws.

## Limited warranty information

Awnings and Canopies are manufactured under the highest standards of production, after comprehensive research and development, and will be warranted by the manufacturer to the original purchaser from date of purchase for a period of Five (5) years against the occurrence of manufacturing defects directly resulting in peeling, flaking, blistering or rusting under conditions of normal use and service, subject to the terms and conditions contained in this Limited Warranty.

The manufacturer does not warrant installation nor defects caused by installation. This Limited Warranty does not cover any other defects as specified herein. This Limited Warranty does not cover any other damage or material failure resulting from, but not limited to, normal weathering, oxidation, accidental damage or intentional damage, fire or flood, windblown objects, windstorm, sleet or chemical pollutants, mildew or structural defects, negligent maintenance or misuse or abuse, or any other causes or occurrences beyond the control of the manufacturer.

Normal weathering may cause any surface to oxidize, chalk, gradually fade or accumulate surface dirt or stains due to varying exposures to sunlight, weather or atmospheric conditions. The geographic location, the quality of the atmosphere and other local factors in the area, over which the manufacturer has no control, contribute to the severity of these conditions.

This Limited Warranty is void if incompatible accessory products are installed which cause defects to occur.

The provisions of this Limited Warranty are the full and complete warranty policy extended by the manufacturer.

This Limited Warranty shall be null and void if harmful cleaning compounds are used.

THE WARRANTY STATEMENTS CONTAINED IN THIS LIMITED WARRANTY SET FORTH THE ONLY EXPRESS WARRANTIES EXTENDED BY THE MANUFACTURER IN LIEU OF ALL OTHER WARRANTIES, AND THE PROVISIONS OF THIS LIMITED WARRANTY SHALL CONSTITUTE THE ENTIRE LIABILITY OF THE MANUFACTURER AND THE PROPERTY OWNER'S EXCLUSIVE REMEDY FOR BREACH OF THIS WARRANTY. THE MANUFACTURER SHALL NOT BE LIABLE TO THE PROPERTY OWNER FOR INCIDENTAL OR CONSEQUENTIAL DAMAGES OF ANY KIND FOR BREACH OF ANY EXPRESS OR IMPLIED WARRANTY.

Some states do not allow the exclusion or limitation of incidental or consequential damages, so the above limitations or exclusions may not apply to you. This Warranty gives you the specific legal rights and you may also have other rights, which vary from state to state.