

ER-285M

ELECTRONIC CASH REGISTER



Optional RJ-45 and Second DB-9 Port Shown.
(Option Board Part No. 501430)



Cable Catalog

August 1, 2008



PC
UTILITY

PRINTER

COIN
DISPENSER

SCALE*

POLE
DISPLAY

KITCHEN
VIDEO

VIDEO
SURVEILLANCE

SCANNER

SD
CARD

INTEGRATED
PAYMENT

MCR

ER-285M Cable Configurations

PC Polling/Communication

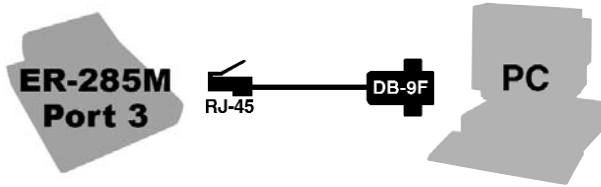

ECR RJ-45		PC DB-9F
DCD	1	1 DCD
DSR	2	2 RXD
TXD	3	3 TXD
RXD	4	4 DTR
RTS	5	5 GND
CTS	6	6 DSR
GND	7	7 RTS
DTR	8	8 CTS

CRS Part No. 522124 – 5 Feet

PC Polling/Communication

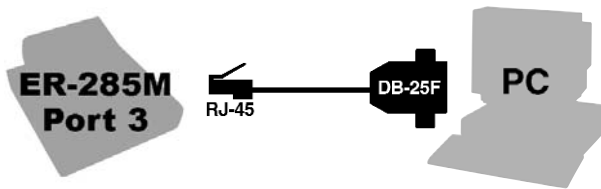

ECR RJ-45		PC DB-25F
DCD	1	0-1 ChGND
DSR	2	2 TXD
TXD	3	3 RXD
RXD	4	4 RTS
RTS	5	5 CTS
CTS	6	6 DSR
GND	7	7 GND
DTR	8	8 DCD
		20 DTR

CRS Part No. 522036 – 5 Feet

PC Polling/Communication

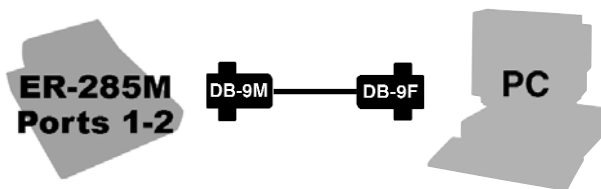

ECR DB-9M		PC DB-9F
DCD	1	1 DCD
RXD	2	2 RXD
TXD	3	3 TXD
DTR	4	4 DTR
GND	5	5 GND
DSR	6	6 DSR
RTS	7	7 RTS
CTS	8	8 CTS
VCC	9	9 VCC

CRS Part No. 522126 – 5 Feet

ER-285M Cable Configurations

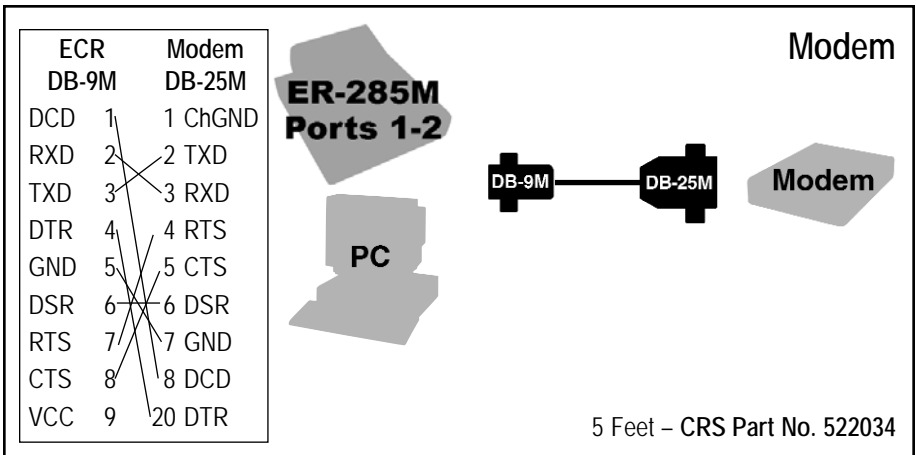
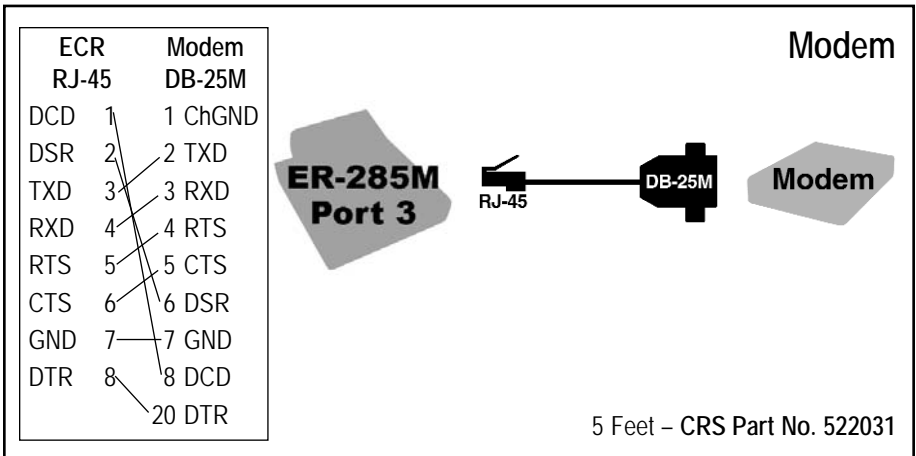
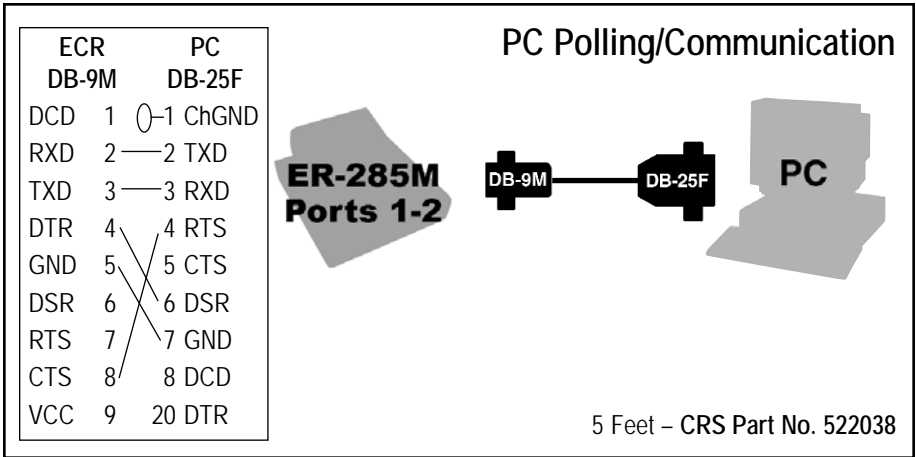

ER-285M Cable Configurations

Printer

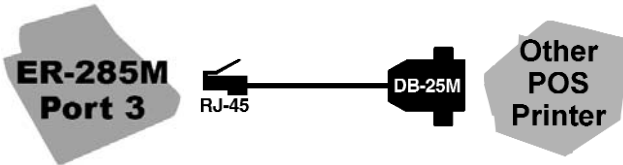

ER-285M Port 3 **RJ-45** **DB-25M** **Other POS Printer**

ECR RJ-45	Printer DB-25M
DCD 1	0-1 ChGND
DSR 2	2 TXD
TXD 3	3 RXD
RXD 4	4 RTS
RTS 5	5 CTS
CTS 6	6 DSR
GND 7	7 GND
DTR 8	8 DCD
	20 DTR

CRS Part No. 522030 – 5 Feet

Printer

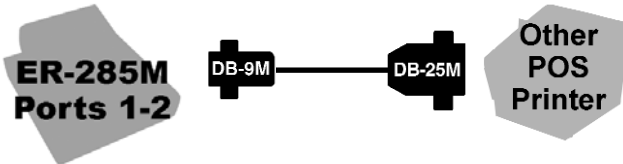

ER-285M Ports 1-2 **DB-9M** **DB-25M** **Other POS Printer**

ECR DB-9M	Printer DB-25M
DCD 1	0-1 ChGND
RXD 2	2 TXD
TXD 3	3 RXD
DTR 4	4 RTS
GND 5	5 CTS
DSR 6	6 DSR
RTS 7	7 GND
CTS 8	8 DCD
VCC 9	20 DTR

CRS Part No. 522033 – 5 Feet

Printer

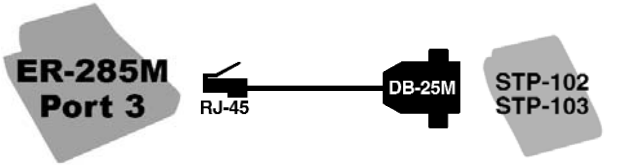

ER-285M Port 3 **RJ-45** **DB-25M** **STP-102 STP-103**

ECR RJ-45	Printer DB-25M
DCD 1	18 RTS
DSR 2	19 RXD
TXD 3	20 TXD
RXD 4	21 CTS
RTS 5	22 GND
CTS 6	23
GND 7	24
DTR 8	25

CRS Part No. 522093 – 5 Feet

ER-285M Cable Configurations

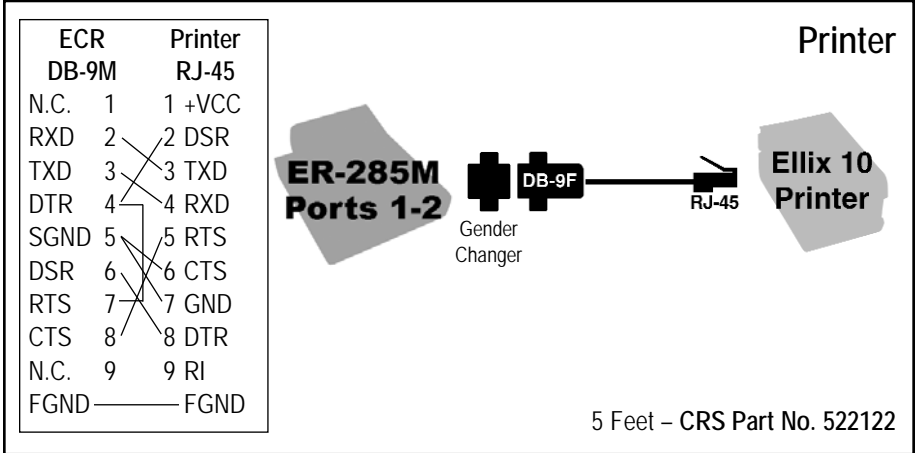
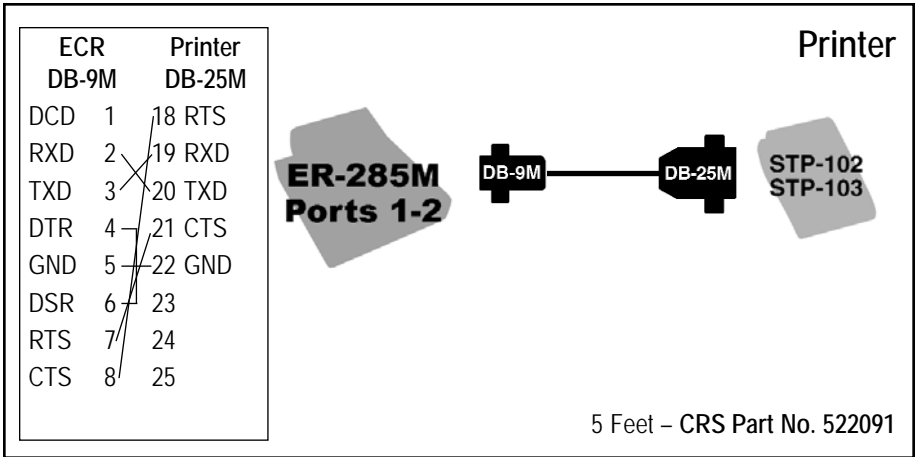

ER-285M Cable Configurations

Printer

ER-285M Port 3 — RJ-45 — DB-25M

Ellix 20 Printer
Bixolon SRP Printer

ECR RJ-45	Printer DB-25M
DCD 1	1 ChGND
DSR 2	2 TXD
TXD 3	3 RXD
RXD 4	4 RTS
RTS 5	5 CTS
CTS 6	6 DSR
GND 7	7 GND
DTR 8	8 DCD
	20 DTR

CRS Part No. 522115 – 5 Feet

Printer

ER-285M Ports 1-2 — DB-9M — DB-25M

Ellix 20 Printer
Bixolon SRP Printer

ECR DB-9M	Printer DB-25M
DCD 1	1 ChGND
RXD 2	2 TXD
TXD 3	3 RXD
DTR 4	4 RTS
GND 5	5 CTS
DSR 6	6 DSR
RTS 7	7 GND
CTS 8	8 DCD
VCC 9	20 DTR

CRS Part No. 522117 – 5 Feet

EPSON DIE-P202 Pole Display

ER-285M Port 3 — RJ-45 — DB-9M — Pole Display

ECR RJ-45	Pole Disp DB-9M
+Vcc 1	1
DSR 2	2 RXD
TXD 3	3
RXD 4	4
RTS 5	5 GND
CTS 6	6
GND 7	7
DTR 8	8 DTR

N/A

ER-285M Cable Configurations

ECR DB-9M	Pole Disp DB-9M
DCD 1	1
RXD 2	2 RXD
TXD 3	3
DTR 4	4
GND 5	5 GND
DSR 6	6
RTS 7	7 DTR
CTS 8	8
+Vcc 9	

EPSON DIE-P202 Pole Display

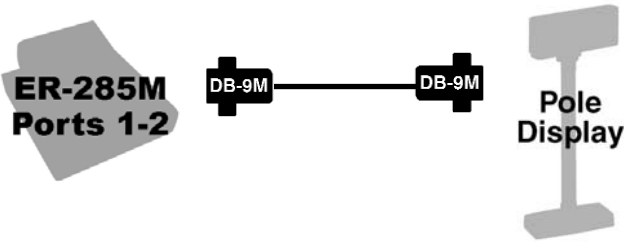

ER-285M Ports 1-2

Pole Display

N/A

ECR RJ-45	Pole Disp DB-9M
DCD 1	1
DSR 2	2 TXD
TXD 3	3 RXD
RXD 4	4
RTS 5	5 GND
CTS 6	6 DSR
GND 7	7
DTR 8	8

ICD-2002 Pole Display

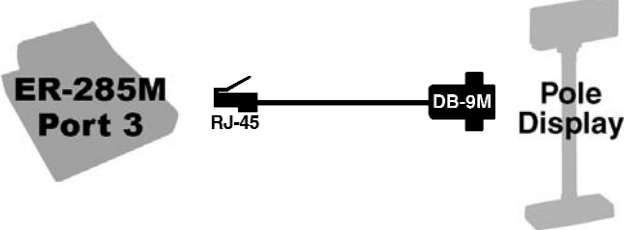

ER-285M Port 3

Pole Display

5 Feet – CRS Part No. 522063

ECR DB-9M	Pole Disp DB-9M
DCD 1	1
RXD 2	2 TXD
TXD 3	3 RXD
DTR 4	4
GND 5	5 GND
DSR 6	6 DSR
RTS 7	7
CTS 8	8

ICD-2002 Pole Display

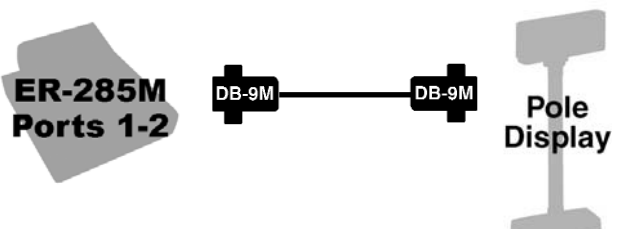

ER-285M Ports 1-2

Pole Display

5 Feet – CRS Part No. 522062

ER-285M Cable Configurations

Coin Dispenser

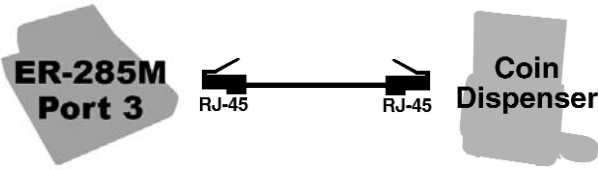

	ECR RJ-45	Coin Disp RJ-45
DTR	1	1
DSR	2	2
TXD	3	3
RXD	4	4
RTS	5	5 TXD
CTS	6	6 RXD
GND	7	7 SG
CD	8	8

N/A

Coin Dispenser

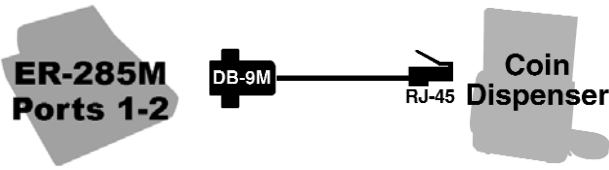

	ECR DB-9M	Coin Disp RJ-45
DCD	1	1
RXD	2	2
TXD	3	3
DTR	4	4
GND	5	5 TXD
DSR	6	6 RXD
RTS	7	7 SG
CTS	8	8
VCC	9	

N/A

Scanner

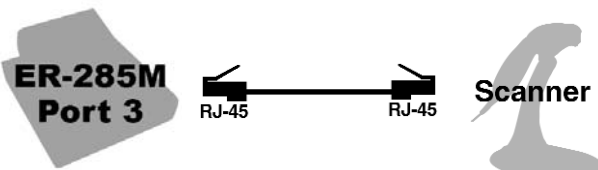

	ECR RJ-45	Scanner RJ-45
	1	1 TXD
DSR	2	2 RXD
TXD	3	3 RTS
RXD	4	4 CTS
RTS	5	5 DSR
CTS	6	6
	7	7 DTR
DTR	8	8

N/A

ER-285M Cable Configurations

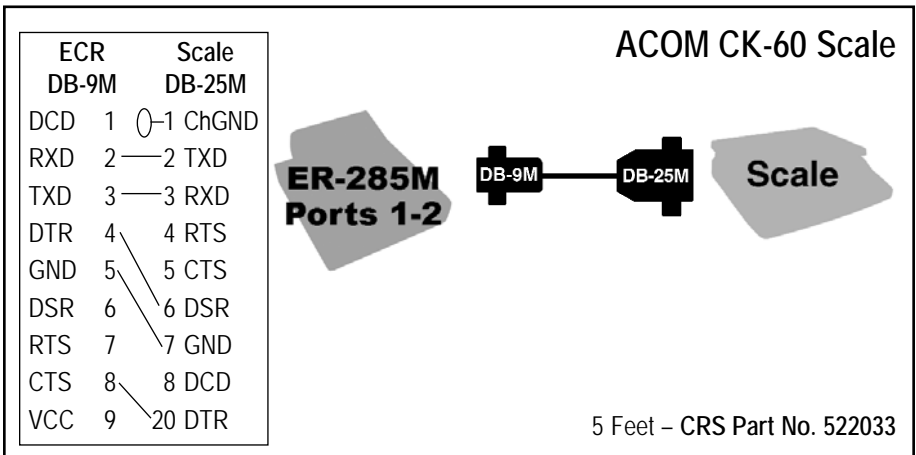
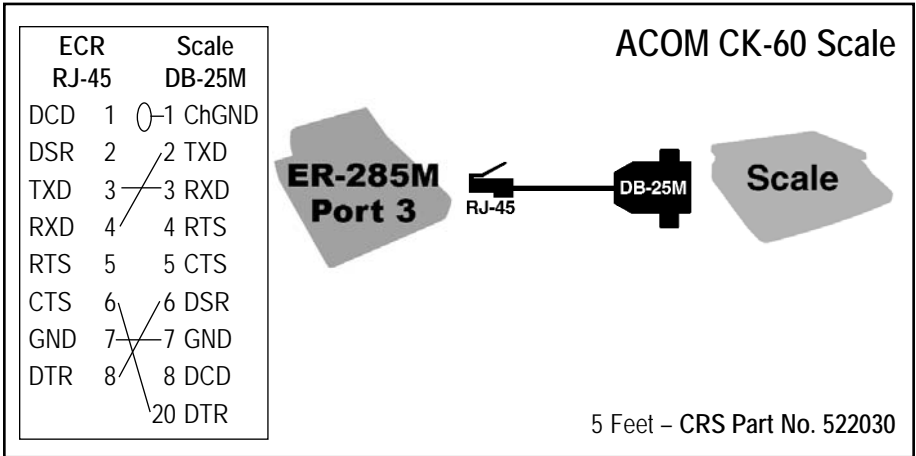
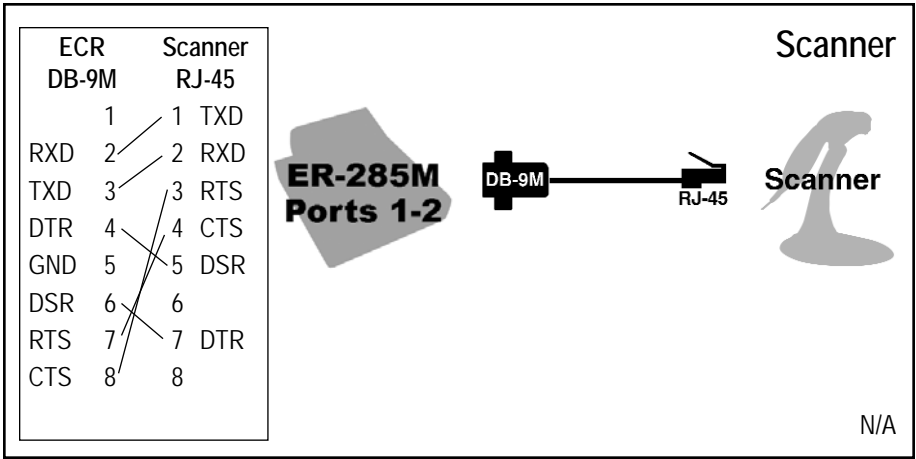

ER-285M Cable Configurations

CAS PD-1 Scale

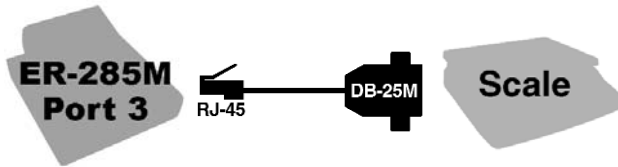

ECR RJ-45	Scale DB-25M
+Vcc 1	1
DSR 2	2
TXD 3	3
RXD 4	4
RTS 5	5 TXD
CTS 6	6 RXD
GND 7	7
DTR 8	8
	23 GND

CRS Part No. 522060 – 5 Feet

CAS PD-1 Scale

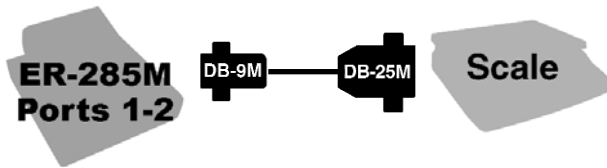

ECR DB-9M	Scale DB-25M
DCD 1	1
RXD 2	2
TXD 3	3
DTR 4	4
GND 5	5 TXD
DSR 6	6 RXD
RTS 7	7
CTS 8	23 GND

CRS Part No. 522059 – 5 Feet

NCI 6710/6720 Scale

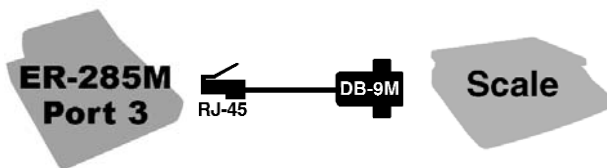

ECR RJ-45	Scale DB-9M
DCD 1	1
DSR 2	2 TXD
TXD 3	3 RXD
RXD 4	4
RTS 5	5 GND
CTS 6	6
GND 7	7
DTR 8	8

CRS Part No. 522057 – 5 Feet

ER-285M Cable Configurations

NCI 6710/6720 Scale

ECR RJ-45	Scale DB-15M
DCD 1	1 RXD
DSR 2	2 TXD
TXD 3	3 GND
RXD 4	4
RTS 5	5
CTS 6	6
GND 7	7
DTR 8	8

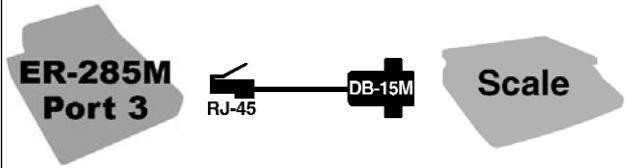

5 Feet – CRS Part No. 522044

NCI 6710/6720 Scale

ECR DB-9M	Scale DB-9M
DCD 1	1
RXD 2	2 TXD
TXD 3	3 RXD
DTR 4	4
GND 5	5 GND
DSR 6	6
RTS 7	7
CTS 8	8
ShieldFR -()	

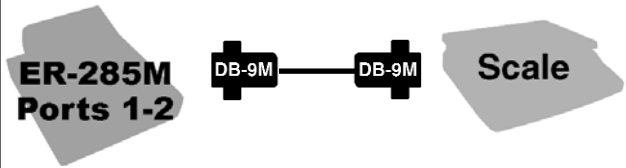

5 Feet – CRS Part No. 522056

NCI 6710/6720 Scale

ECR DB-9M	Scale DB-15M
DCD 1	1 RXD
RXD 2	2 TXD
TXD 3	3 GND
DTR 4	4
GND 5	5
DSR 6	6
RTS 7	7
CTS 8	8
ShieldFR -()	

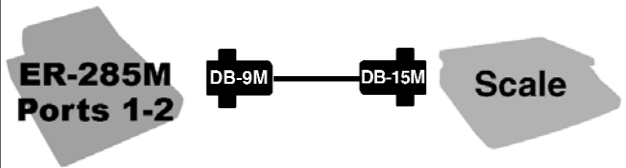

5 Feet – CRS Part No. 522043

ER-285M Cable Configurations

NCI 4100 Scale

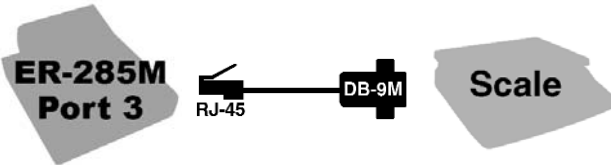

ECR RJ-45	Scale DB-9M
+Vcc 1	1 GND
DSR 2	2
TXD 3	3 TXD
RXD 4	4
RTS 5	5
CTS 6	6
GND 7	7
DTR 8	8
	9 RXD

N/A

NCI 4100 Scale

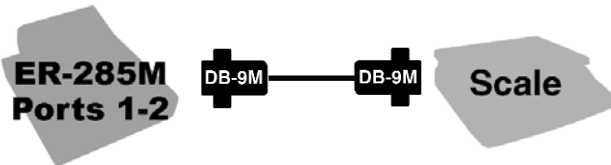

ECR DB-9M	Scale DB-9M
DCD 1	1 GND
RXD 2	2
TXD 3	3 TXD
DTR 4	4
GND 5	5
DSR 6	6
RTS 7	7
CTS 8	8
	9 RXD

N/A

DataTran

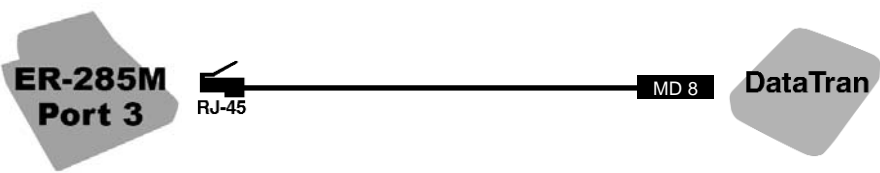

CRS Part No. 522071 – 6 Feet

ER-285M Cable Configurations

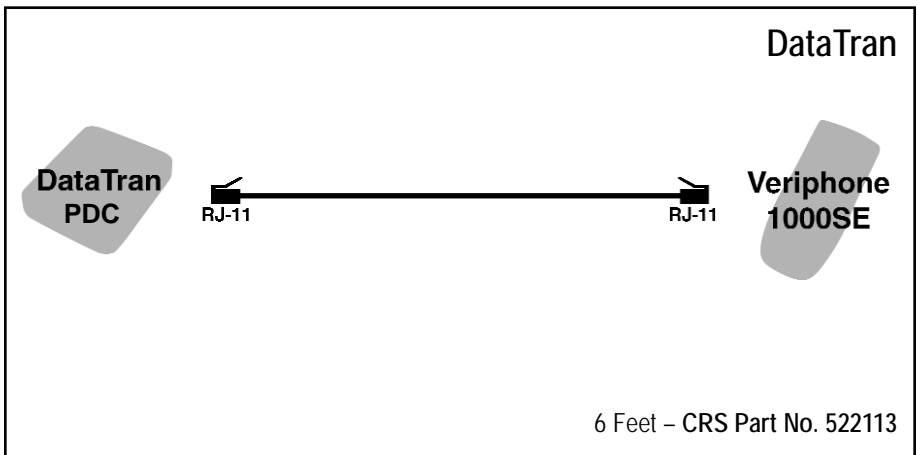
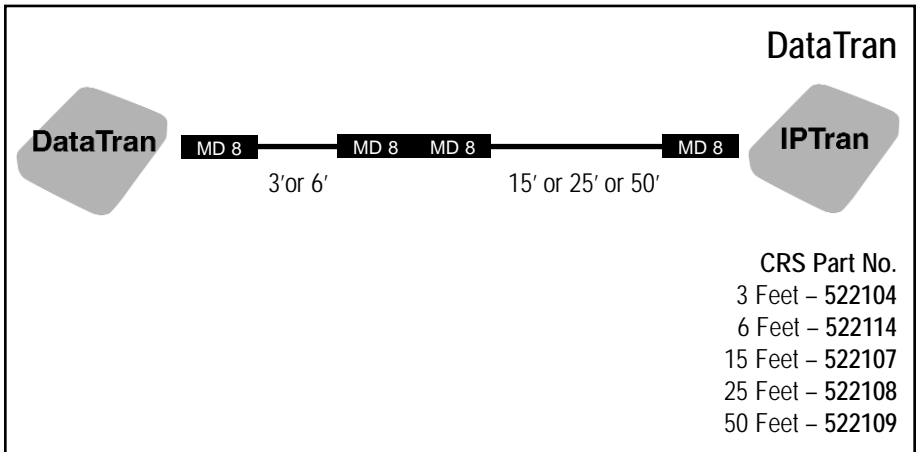
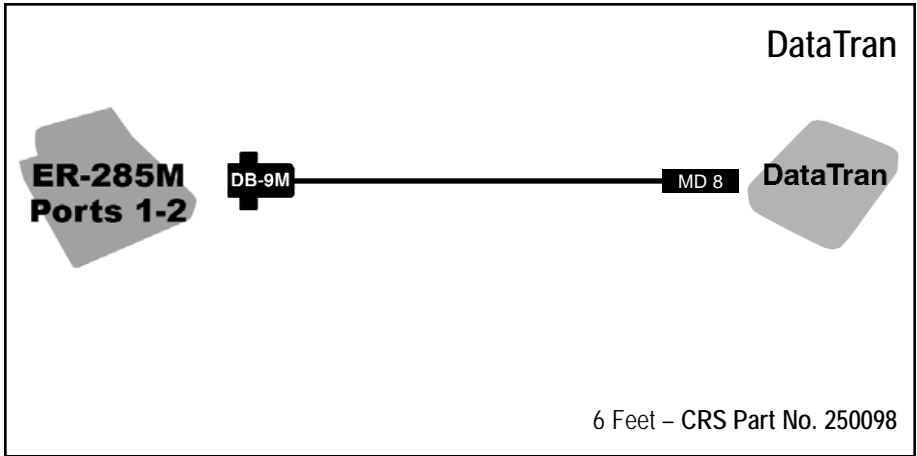

ER-285M Cable Configurations

DataTran

**ER-285M
Ports 1-2**

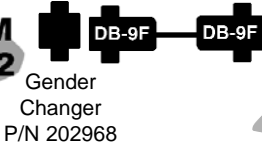

**PC
with
IPEnabler**

ECR DB-9F		PC DB-9F
DCD	1	1 DCD
RXD	2	2 RXD
TXD	3	3 TXD
DTR	4	4 DTR
GND	5	5 GND
DSR	6	6 DSR
RTS	7	7 RTS
CTS	8	8 CTS
		SHELL — SHELL

CRS Part No. 250056 – 6 Feet

DB-9 to RJ-45 Adapter

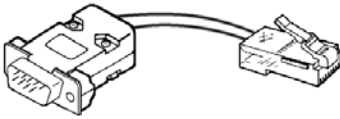

DB-9M		RJ-45
DCD	1	1 DCD
RXD	2	2 DSR
TXD	3	3 TXD
DTR	4	4 RXD
GND	5	5 RTS
DSR	6	6 CTS
RTS	7	7 GND
CTS	8	8 DTR
VCC	9	

CRS Part No. 522119