

SAM4S

ER-350II Electronic Cash Register

Operator's and Programming Manual

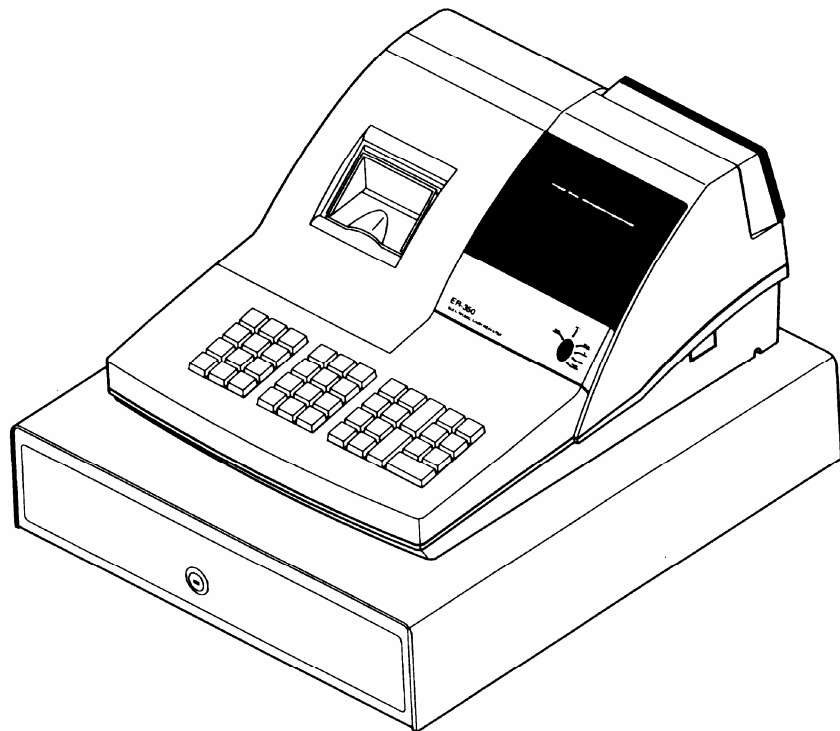

*For Fast Startup, See
"Quick Setup" on page 7*

All specifications are subject to change without notice.

©2010, CRS, Inc.
M-ER350II Version 1.6

CRS, Inc.

Limited Warranty and Disclaimers of Warranty

This manual has been developed by CRS, Inc. It is intended for the use of its customers and service personnel and should be read in its entirety before attempting to install, use or program the product(s).

Nothing contained in this manual shall be deemed to be, and this manual does not constitute, a warranty of, or representation with respect to, the product or any of the products to which this manual applies. This manual is subject to change without notice and CRS, Inc. has no obligation to provide any updates or corrections to this manual. Further, CRS, Inc. also reserves the right, without prior notice, to make changes in equipment design or components as it deems appropriate. No representation is made that this manual is complete or accurate in all respects and CRS, Inc. shall not be liable for any errors or omissions contained in this manual. In no event shall CRS, Inc. be liable for any incidental or consequential damages relating to or arising out of the use of this manual. This document contains proprietary information that is protected by copyright. All rights are reserved. No part of this document may be photocopied or reproduced without prior written consent of CRS, Inc.

NOTICE

IF ANY WARRANTY IS EXTENDED TO YOU WITH REGARD TO THE PRODUCT(S) TO WHICH THIS MANUAL APPLIES, IT IS A WARRANTY FROM THE ENTITY OR INDIVIDUAL FROM WHOM YOU DIRECTLY PURCHASED THE PRODUCT(S).

SUBJECT TO THE FOREGOING, UNLESS YOU ARE A DIRECT END USER CUSTOMER OF CRS, INC., CRS, INC. DOES NOT EXTEND TO YOU ANY EXPRESS WARRANTY OR ANY IMPLIED WARRANTY AND EXPRESSLY DISCLAIMS ANY IMPLIED WARRANTY OF MERCHANTABILITY, FITNESS FOR USE, OR FITNESS FOR ANY PARTICULAR PURPOSE, OR ANY WARRANTY OF NON-INFRINGEMENT OF INTELLECTUAL PROPERTY RIGHTS IN CONNECTION WITH THE PRODUCT(S) OR ANY SOFTWARE, DRIVERS, OR PROGRAMMING PRODUCT, WHETHER EMBEDDED IN PRODUCT(S) OR PROVIDED AS A SEPARATE PROGRAM, OR USED IN CONJUNCTION WITH THIS/THESE PRODUCT(S). CRS, INC. SPECIFICALLY DOES NOT WARRANT THAT THE OPERATION OF ANY DRIVERS, SOFTWARE, OR PROGRAMMING PRODUCTS LICENSED HEREUNDER, WHETHER EMBEDDED IN PRODUCTS OR PROVIDED AS SEPARATE PROGRAMS, SHALL BE UNINTERRUPTED OR ERROR FREE OR THAT FUNCTIONS CONTAINED IN SUCH DRIVERS, SOFTWARE OR PROGRAMMING PRODUCTS SHALL OPERATE IN COMBINATION(S) WHICH MAY BE SELECTED FOR USE BY YOU OR OTHERWISE MEET YOUR REQUIREMENTS.

CRS, Inc. is not responsible for any damages or loss, either direct, indirect, special, incidental or consequential, which you may experience as a result of your purchase or use of the product(s). Your sole remedy in the event that you encounter any difficulties with the product(s) is against the entity or individual from whom you purchased the product(s).

Revision 2.0 - April 1, 2005

WARNING - U.S.

THIS EQUIPMENT GENERATES, USES AND CAN RADIATE RADIO FREQUENCY ENERGY, AND IF NOT INSTALLED AND USED IN ACCORDANCE WITH THE INSTRUCTIONS MANUAL, MAY CAUSE INTERFERENCE TO RADIO COMMUNICATIONS. IT HAS BEEN TESTED AND FOUND TO COMPLY WITH THE LIMITS FOR A CLASS A COMPUTING DEVICE PURSUANT TO SUBPART J OF PART 15 OF FCC RULES WHICH ARE DESIGNED TO PROVIDE REASONABLE PROTECTION AGAINST SUCH INTERFERENCE WHEN OPERATED IN A COMMERCIAL ENVIRONMENT. OPERATIONS OF THE EQUIPMENT IN A RESIDENTIAL AREA IS LIKELY TO CAUSE INTERFERENCE IN WHICH CASE THE USER, AT HIS OWN EXPENSE, WILL BE REQUIRED TO TAKE WHATEVER MEASURES MAY BE REQUIRED TO CORRECT THE INTERFERENCE.

NOTICE - CANADA

THIS APPARATUS COMPLIES WITH THE CLASS "A" LIMITS FOR RADIO INTERFERENCE AS SPECIFIED IN THE CANADIAN DEPARTMENT OF COMMUNICATIONS RADIO INTERFERENCE REGULATIONS.

CET APPAREIL EST CONFORME AUX NORMES CLASS "A" D'INTERFERENCE RADIO TEL QUE SPECIFIER PAR MINISTRE CANADIEN DES COMMUNICATIONS DANS LES REGLEMENTS D'INTERFERENCE RADIO.

ATTENTION



The product that you have purchased may contain a battery that may be recyclable. At the end of its useful life, under various state and local laws, it may be illegal to dispose of the battery into the municipal waste system.

Check with your local solid waste officials for details concerning recycling options or proper disposal.

Precaution Statements

Follow these safety, servicing and ESD precautions to prevent damage and to protect against potential hazards such as electrical shock.

1-1 Safety Precautions

1. Be sure that all built-in protective devices are replaced. Restore any missing protective shields.
2. When reinstalling the chassis and its assemblies, be sure to restore all protective devices, including nonmetallic control knobs and compartment covers.
3. Make sure there are no cabinet openings through which people - particularly children - might insert fingers and contact dangerous voltages. Such openings include excessively wide cabinet ventilation slots and improperly fitted covers and drawers.
4. Design Alteration Warning:
Never alter or add to the mechanical or electrical design of the SECR. Unauthorized alterations might create a safety hazard. Also, any design changes or additions will void the manufacturer's warranty.
5. Components, parts and wiring that appear to have overheated or that are otherwise damaged should be replaced with parts that meet the original specifications. Always determine the cause of damage or over-heating, and correct any potential hazards.
6. Observe the original lead dress, especially near the following areas : sharp edges, and especially the AC and high voltage supplies. Always inspect for pinched, out-of-place, or frayed wiring. Do not change the spacing between components and the printed circuit board. Check the AC power cord for damage. Make sure that leads and components do not touch thermally hot parts.
7. Product Safety Notice:
Some electrical and mechanical parts have special safety-related characteristics which might not be obvious from visual inspection. These safety features and the protection they give might be lost if the replacement component differs from the original - even if the replacement is rated for higher voltage, wattage, etc.
Components that are critical for safety are indicated in the circuit diagram by shading, () or (). Use replacement components that have the same ratings, especially for flame resistance and dielectric strength specifications. A replacement part that does not have the same safety characteristics as the original might create shock, fire or other hazards.

CAUTION

Danger of explosion if battery is incorrectly replaced.

Replace only with the same or equivalent type recommended by the manufacturer.

Dispose used batteries according to the manufacturer's instructions.

ATTENTION

Il y a danger d'explosion s'il y a un remplacement incorrect de la batterie.

Remplacer uniquement avec une batterie du même type ou d'un type équivalent recommandé par le constructeur.

Mettre au rebut les batteries usagées conformément aux instructions du fabricant.

SAFETY NOTICE : "For pluggable equipment, the socket-outlet shall be installed near the equipment and shall be easily accessible."

1-2 Servicing Precautions

WARNING: First read the-Safety Precautions-section of this manual. If some unforeseen circumstance creates a conflict between the servicing and safety precautions, always follow the safety precautions.

WARNING: An electrolytic capacitor installed with the wrong polarity might explode.

1. Servicing precautions are printed on the cabinet. Follow them.
2. Always unplug the units AC power cord from the AC power source before attempting to:
 - (a) Remove or reinstall any component or assembly
 - (b) Disconnect an electrical plug or connector
 - (c) Connect a test component in parallel with an electrolytic capacitor
3. Some components are raised above the printed circuit board for safety. An insulation tube or tape is sometimes used. The internal wiring is sometimes clamped to prevent contact with thermally hot components. Reinstall all such elements to their original position.
4. After servicing, always check that the screws, components and wiring have been correctly reinstalled. Make sure that the portion around the serviced part has not been damaged.
5. Check the insulation between the blades of the AC plug and accessible conductive parts (examples : metal panels and input terminals).
6. Insulation Checking Procedure:

Disconnect the power cord from the AC source and turn the power switch ON. Connect an insulation resistance meter (500V) to the blades of AC plug.

The insulation resistance between each blade of the AC plug and accessible conductive parts (see above) should be greater than 1 megohm.
7. Never defeat any of the B+ voltage interlocks. Do not apply AC power to the unit (or any of its assemblies) unless all solid-state heat sinks are correctly installed.
8. Always connect an instrument's ground lead to the instrument chassis ground before connecting the positive lead ; always remove the instrument's ground lead last.

1-3 Precautions for Electrostatically Sensitive Devices (ESDs)

1. Some semiconductor (solid state) devices are easily damaged by static electricity. Such components are called Electrostatically Sensitive Devices (ESDs); examples include integrated circuits and some field-effect transistors. The following techniques will reduce the occurrence of component damage caused by static electricity.
2. Immediately before handling any semiconductor components or assemblies, drain the electrostatic charge from your body by touching a known earth ground. Alternatively, wear a discharging wrist-strap device. (Be sure to remove it prior to applying power - this is an electric shock precaution.)
3. After removing an ESD-equipped assembly, place it on a conductive surface such as aluminum foil to prevent accumulation of electrostatic charge.
4. Do not use freon-propelled chemicals. These can generate electrical charges that damage ESDs.
5. Use only a grounded-tip soldering iron when soldering or unsoldering ESDs.
6. Use only an anti-static solder removal device. Many solder removal devices are not rated as anti-static; these can accumulate sufficient electrical charge to damage ESDs.
7. Do not remove a replacement ESD from its protective package until you are ready to install it. Most replacement ESDs are packaged with leads that are electrically shorted together by conductive foam, aluminum foil or other conductive materials.
8. Immediately before removing the protective material from the leads of a replacement ESD, touch the protective material to the chassis or circuit assembly into which the device will be installed.
9. Minimize body motions when handling unpackaged replacement ESDs. Motions such as brushing clothes together, or lifting a foot from a carpeted floor can generate enough static electricity to damage an ESD

Contents

Introduction	1
Using This Manual	1
Using Flowcharts.....	1
Basic Features and Functions	2
Keyboard	2
Control Lock	4
Display	5
Quick Setup	7
Unpacking.....	7
Installing the Paper	7
Installing the Ribbon Cartridge	10
Clearing Memory.....	11
Basic Programming	12
Setting the Date	12
Setting the Time	12
Programming Tax.....	13
Programming a Taxable Department.....	15
Basic Operations.....	16
Registering Items.....	16
Totaling a Cash Sale.....	17
Tendering a Cash Sale.....	17
Tendering a Check Sale.....	18
Totaling a Charge Sale	18
Advanced Operating Instructions	19
Clerk Operations.....	19
Clerk Sign On.....	19
Clerk Sign Off	19
Department Registrations	20
Open Department	20
Preset Price Department	20
Department Repeat Entry	21
Multiplication	21
Department Multiplication With Decimal Point.....	22
Split Pricing.....	22
Single Item Department.....	23
PLU (Price Look Up) Registrations	24
Open PLU.....	24
Preset Price PLU	24
PLU Repeat Entry	24
PLU Multiplication.....	25
PLU Multiplication With Decimal Point.....	25

Split Pricing PLU	26
Shifting or Exempting Tax	27
Shifting Tax	27
Exempting Tax	28
Percent Key (+% and -%) Operations.....	29
Preset Percent on a Department or PLU Item.....	29
Enter a Percent on a Department or PLU	29
Percent On Sale Total	30
Return Merchandise Registrations	30
Voids and Corrections	31
Void Last Item.....	31
Void Previous Item.....	31
Cancel.....	32
Void Position Operations	32
- (Minus) Key Registrations	33
No Sale Operations	34
Open Drawer	34
Non Add Number	34
Received On Account Operations.....	35
Paid Out Operations.....	35
Totaling and Tendering.....	36
Subtotaling a Sale	36
Totaling a Cash Sale.....	36
Tendering a Cash Sale	37
Tendering a Check Sale.....	37
Totaling a Charge Sale	38
Check Cashing.....	38
Split Tender	39
Post Tender.....	40
Currency Conversion.....	41
Add Check.....	42
Receipt On/Off and Receipt on Request.....	43

Advanced Programming Instructions 45

Department Programming.....	45
Programming Department Status.....	45
Programming Department Entry Limit or Price	48
System Option Programming.....	50
System Option Table	52
Advanced Tax Programming	54
Tax Rate Programming.....	54
Tax Table Programming.....	56
+% and -% Key Programming.....	58
- (Minus) Key Programming.....	60
CANCEL Key Programming.....	62
Programming the CANCEL Key.....	62
Currency Conversion	63
Programming Clerks	64
PLU (Price Look Up) Programming.....	66
Programming PLU Status.....	66
Programming PLU Entry Limit or Price	69
Setting a Register Number	71
Programming Descriptions	72
Customer Logo.....	72

Department Descriptor	74
PLU Descriptor	75
Code Table	76
Setting Receipt/Journal Status	77
Printing a Programming Report.....	77

Reports 79

Report Summary	79
Running a Report	80
Cash-In-Drawer Declaration.....	80
Declaring Cash	80
Report Samples	81
Financial Report	81
Hourly Sales Report	84
PLU Report	85
Clerk Report	86
Cash-in-Drawer Report	87
Check-in-Drawer Report	87
System Balancing	88
Department Sales Total	88
Net Total.....	88
Gross Total	88
Grand Total	88

Manual Revision Record 89

Introduction

Using This Manual

Congratulations! You have selected a very flexible electronic cash register designed for years of reliable service. The *SAM4s ER-350II* will fit many retail stores, shops and restaurants. It provides fast transaction processing, security, and detailed sales information.

- To Get Started turn to “Quick Setup” on page 7. This section covers unpacking, memory clearing, a few simple programming steps, and instructions for basic cash register transactions. All of the features of the *SAM4s ER-350II* (except the clerk functions) operate immediately, without additional programming steps. In most cases, all the programming you need to do is covered in this section.
- For information about reports and balancing see “Reports” on page 79.

This manual also includes detailed information about many additional features that will help you solve the special calculation problems or security issues that you might face.

- For detailed programming instructions, see “Advanced Programming” on page 45.
- For detailed operations sequences, see “Advanced Operating Instructions” on page 19.

Using Flowcharts

Flowcharts are used to supplement step by step instructions throughout this manual. For example, the following flowchart describes how to register \$1.00 into department **1/9**:



This flowchart means:

1. Press numeric key **1**.
2. Press numeric key **0**.
3. Press numeric key **0**.
4. Press department **1/9**.

Follow the flowchart from left to right, pressing the keys in the order they are shown. Numeric keypad entries are shown as square keys. Department and function keys are shown as rectangular keys.

Basic Features and Functions

Keyboard

PAPER FEED	#/NO SALE	@/FOR	7	8	9	4/12	8/16	DEPT SHIFT	CLERK #	RECD ACCT
-	+%	-%	4	5	6	3/11	7/15	PLU	ADD CHECK	PAID OUT
CANCEL	MDSE RTRN	VOID	1	2	3	2/10	6/14	SUB TOTAL	CHARGE	CHECK TEND
C/ CONV	TAX SHIFT	CLEAR	0	00	.	1/9	5/13		CASH/TEND	

Key Descriptions

Key	Description
PAPER FEED	Press to advance then printer paper.
Numeric Keypad: 0-9 and 00	Use the numeric keypad to enter amounts, other numeric values.
CLEAR	Press to clear numeric errors made on keyboard prior to pressing the registration key. Also press to stop the error alarm when incorrect entries are made.
Department Keys	There are eight department keys on the keyboard to register different types of merchandise. (Eight additional department classifications are available by using the DEPT SHIFT key, for a total of 16 department classifications.) Departments may be used to accept open priced entries, or may be programmed to register preset prices
DEPT SHIFT	Press the Department Shift key before pressing a department to access departments 9 to 16 .
#/NO SALE	Press to open the cash drawer when you have not already started a transaction. Also, may be used to print any number (up to 8 digits) on the printer paper.
@/FOR	Enter a quantity, then press the @/FOR key to enter multiple items. Also use to enter "split pricing" items, such as 1 item at 3 for \$.89.
VOID	Press to void (or erase) the last item entered. You can also void an item previously entered within a transaction by pressing SUBTOTAL , then VOID then re-entering the item you wish to correct.

RTRN MDSE	If you wish to return or refund an item, press Return Merchandise, then re-enter any item you wish.
- (MINUS)	Register a negative amount by entering a price, then pressing the - (MINUS) key. For example, you can enter bottle returns or coupons using the - (MINUS) key.
CANCEL	Press to void (or erase) all items entered thus far in any transaction.
C/CONV	Press the Currency Conversion key to convert the sale subtotal into an equivalent value in foreign currency. You must first program foreign currency exchange rates. See “Currency Conversion” on page 63.
-% , +%	Use the Percent keys to add a percentage surcharge or subtract a percentage from an item or the subtotal of the sale. You can enter the amount of the percentage before pressing the -% or +% keys, or you can program a preset percentage if you are consistently using the same percentage. See “+% and -% Key Programming” on page 58 to set a preset percentage.
PLU	Use to register a Price Look Up (PLU).
RECD ACCT	Use to accept cash into the cash drawer when you are not actually selling merchandise. For example, use the Received on Account key to accept payments for previously sold merchandise, or record loans to the cash drawer.
PAID OUT	Use to track cash paid out for merchandise or to record loans from the cash drawer.
TAX SHIFT	Press to reverse the programmed tax status of a department key. For example, by using the TAX SHIFT key prior to registering a taxable item, the item will be sold without sales tax added.
. (Decimal)	Use the Decimal key to enter fractions of percentages. For example to enter a one third off discount, enter 3 3 . 3 3 before pressing the -% key.
CLERK #	Use to sign on or sign off a clerk, if you have decide to use a clerk sales tracking system. See “Programming Clerks” on page 64.
SUB TOTAL	Press to see the subtotal of a sale.
CHARGE	Press to total a transaction paid by charge or credit card.
CHECK	Press to total a transaction paid by check. Also if the check amount is over the amount purchased, enter the amount of the check, then press the CHECK key. The drawer will open and the cash change will be computed.
CASH/TEND	Press to total a transaction paid by cash. Also if the cash amount tendered is over the amount purchased, enter the amount of the tender, then press the CASH/TEND key. The drawer will open and the cash change will be computed.
ADD CHECK	Press when you wish to issue a receipt, but not yet pay for the sale. For example, one person may wish to pay for two guest checks at a restaurant, or one person may pay for two admissions, where separate receipts are required for each person.

Control Lock

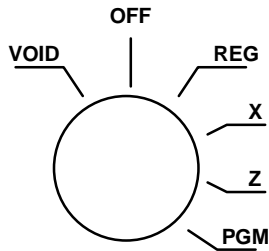

- VOID** Use to void (correct) items outside of a sale.
- OFF** The register is inoperable.
- REG** Use for normal registrations.
- X** Use to read register reports.
- Z** Use to read register reports and reset totals to zero.
- PGM** Use to program the register.

The *SAM4s ER-350II* includes two sets of keys that may be used to access the following key lock positions.

<u>Key</u>	<u>Positions Accessible</u>
VD	VOID, OFF, REG, X
REG	OFF, REG
Z	VOID, OFF, REG, X, Z
P	VOID, OFF, REG, X, Z, PGM
C	ALL POSITIONS

Note: Keys may be removed from the key lock in the OFF or REG positions.

Display

Front Display



DPT	Indicates the department number of the registration (2 digits).
RPT	Indicates the number of times an item has been repeated.
AMOUNT	Displays the amount the amount of the item, subtotal or total.
CLERK	If the clerk system is implemented, one of 10 lines illuminate indicating which clerk is active.

Display Messages

C	Change Due
E	Error
-	Negative entry
=	Total
E1	Input Error
E3	Printer Error (paper jam)
E8	No Paper
E11	Amount Tender Compulsory on CASH or CHECK

Rear Display

The rear display may be lifted and turned for easy customer viewing.

Quick Setup

Unpacking

1. Unpack and Unwrap the cash register.
2. Locate in the packing the following items:
 - 1 roll of paper
 - 1 ribbon cartridge
 - 1 rewind spindle
 - 1 set of control keys
3. Remove the cardboard protectors from the cash drawer.
4. Plug the register into a grounded outlet (three prong), insert a control key and turn the key to the **REG** control lock position.

Installing the Paper

1. Remove the printer cover.

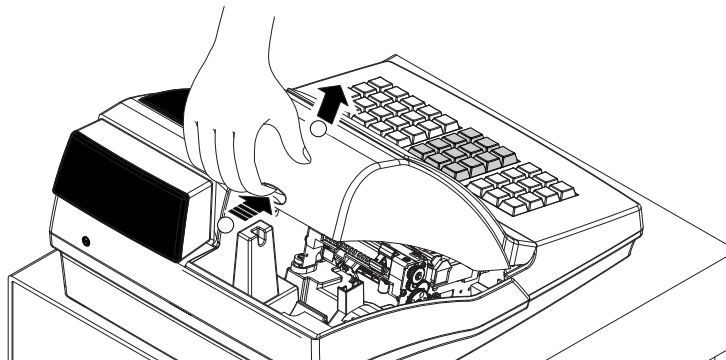

2. For proper feeding through the print head, cut or tear a straight even edge on the end of the paper roll. Place the paper roll in the paper holder so that the paper will feed from the bottom of the roll.

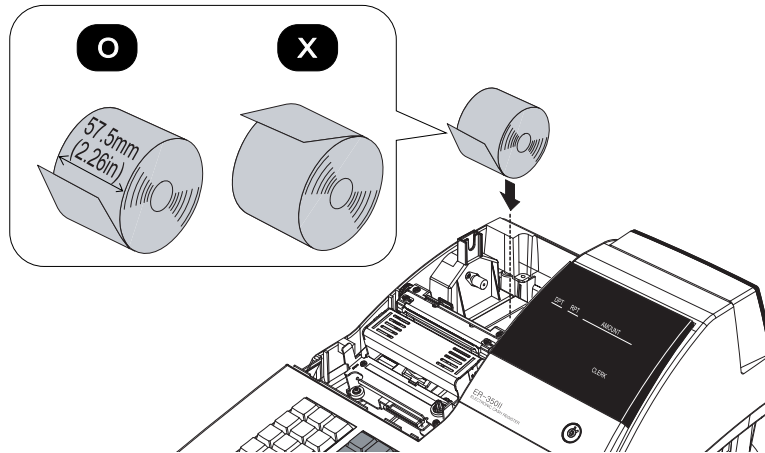

3. Insert the end of the paper into the paper slot.

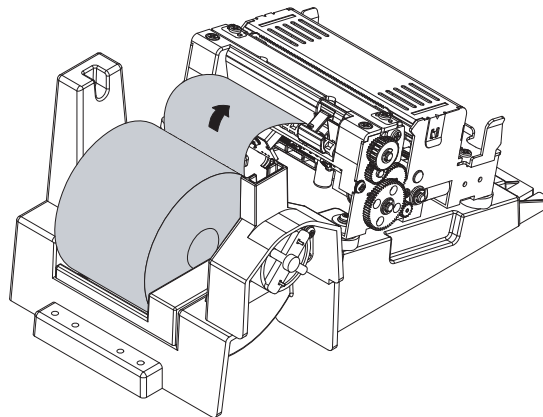

4. Press the **PAPER FEED** key until the paper comes out about 8 inches. If the “E8” message is displayed, press the **CLEAR** key.

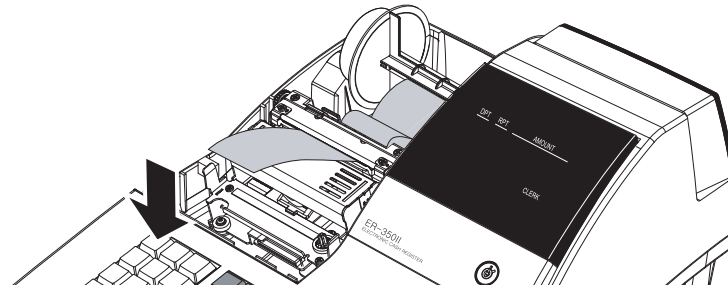

5. If you wish to use the printer to print a sales journal, insert the paper into the paper take-up spool. Also see “Setting Receipt/Journal Status” on page 77. Wind the paper two or three turns around the spool shaft and install the spool in the mount. The illustration below show the use of 2-ply carbonless paper, so that both a journal and receipt are printed.

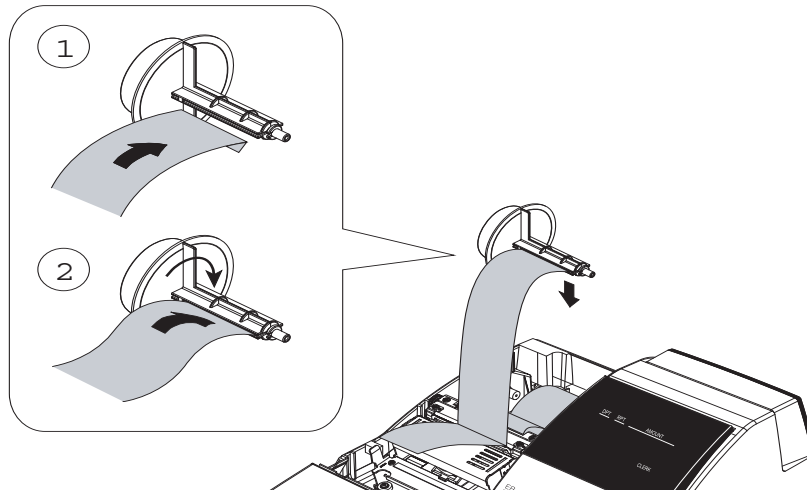

6. If you wish to use the printer to print customer receipts, pass the paper through the window of the printer cover and replace the printer cover.

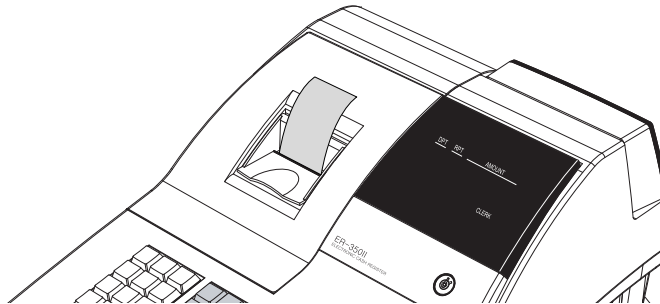

Installing the Ribbon Cartridge

1. Remove the printer cover.
2. If you are replacing a worn ribbon, lift up to remove the old cartridge. You must install the first cartridge on a new cash register.
3. Insert the new ribbon cartridge firmly into place.
4. Turn the post on the ribbon cartridge to tighten the ribbon.
5. Replace the printer cover

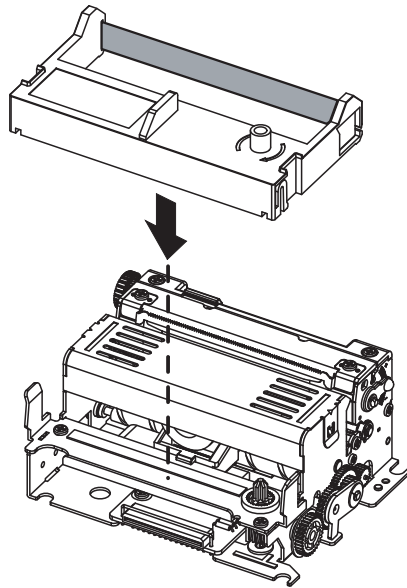

Clearing Memory

This step insures that the cash register is cleared of any totals or programming. After this procedure, the cash register is ready for programming and operation.

WARNING: This is a one time procedure. Do not repeat this procedure after the cash register is programmed, it causes all programs and totals to be erased.

1. Unplug the register.
2. Turn the control lock to **PGM** position.
3. Press and hold the **CLEAR** key while connecting the AC plug into a power outlet.

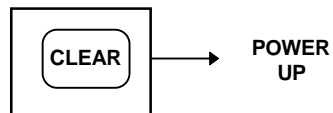

4. When memory is cleared, the register prints:

INITIAL RAM ALL CLEAR

Basic Programming

This section covers the basic programming necessary to get your cash register running quickly. See “Advanced Programming” on page 45 for if you wish to program options that are not included in this section.

Setting the Date

The date sequence is Month-Day-Year.

1. Turn the control lock to the **PGM** position.
2. Enter the date in the format you have selected and press the **@/FOR** key.
3. Press **CASH/TEND**.



Date Setting Example

If the date is March 1, 1999, enter:

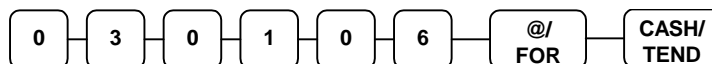

The date you have entered will display and print on the printer:

03-01-2006

Setting the Time

1. Turn the control lock to the **PGM** position.
2. Enter the hour and minute in military time (24 hour time) and press the **@/FOR** key.
3. Press **CASH/TEND**.



Time Setting Example

If the time is 3:25 PM, enter:

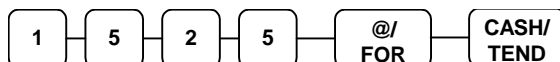

The time you have entered will display and print on the printer:

15:25

Programming Tax

Most sales taxes can be programmed by entering a tax percentage rate. However, in some cases you may find that tax that is entered as a percentage does not follow exactly the tax chart that apply in your area. If this is the case, you must enter your tax using tax table programming. This method will match tax collection exactly to the break points of your tax table. See “Tax Table Programming” on page 56.

Important Note: After you have entered your tax program, test for accuracy by entering several transactions of different dollar amounts. Carefully check to make sure the tax charged by the cash register matches the tax amounts on the printed tax chart for your area. As a merchant, you are responsible for accurate tax collection. If the cash register is not calculating tax accurately, or if you cannot program your tax properly from the information in this manual, contact your local SAM4s dealer for assistance.

Programming a Tax Rate Percentage

1. Turn the control lock to the **PGM** position.
2. Enter the rate, with a decimal. 0.000-99.999. It is not necessary to enter proceeding zeros. For example, for 6%, enter 06.000 or 6.000.)
3. Enter **00**.
4. Enter:

1	to set tax rate 1
2	to set tax rate 2
3	to set tax rate 3

5. Press the **TAX SHIFT** key.
6. Press the **CASH/TEND** key to end programming.
7. See tax rate program examples on page 14.

Tax Rate Programming Flowchart

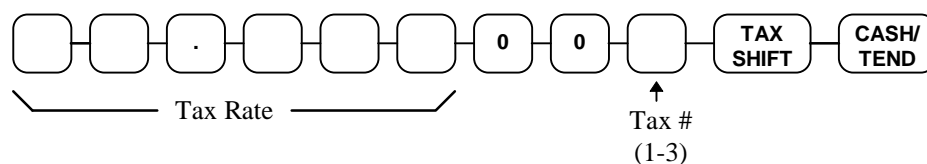

Please Note: After programming the tax rate, you must program your department or departments taxable to calculate tax. See page 15 for department programming steps.

Tax Rate Programming Example

If tax 1 is 6 percent, enter:

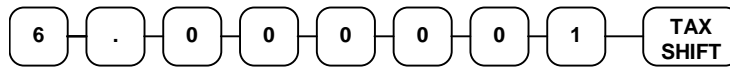

If tax 2 is 7.5 percent, enter:

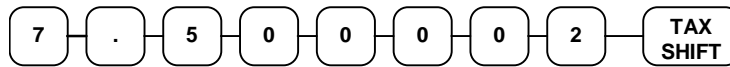

If tax 3 is 10 percent, enter:

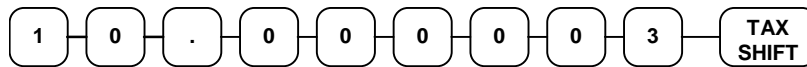

Press the **CASH/TEND** key to end programming.



The rates you have entered will display and print on the printer:

TAX1 STATUS	00
TAX1 RATE	6.000
TAX2 STATUS	00
TAX2 RATE	7.500
TAX3 STATUS	00
TAX3 RATE	10.000
PROGRAM TERMINATE	
01-03-1999	16:36
000013	0

Programming a Taxable Department

1. Turn the control lock to the **PGM** position.
2. Complete the tax status table below by adding the status digits for each tax. Then enter the resulting tax status code.

Taxable by Rate 1?	Yes = 1 No = 0		+
Taxable by Rate 2?	Yes = 2 No = 0		+
Taxable by Rate 3?	Yes = 4 No = 0		+
			=

3. Press the **@/FOR** key.
4. Press the department key you wish to program, or press **DEPT SHIFT** and the appropriate department if you are programming departments 9-16.
5. Repeat steps 2, 3 and 4 for each department you wish to program.
6. Press the **CASH/TEND** key to end programming.

Taxable Department Programming Flowchart

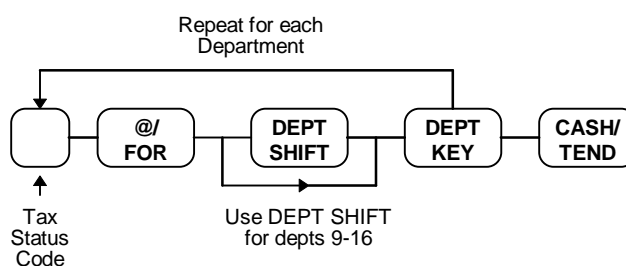

Taxable Department Programming Example

Set department 1 taxable by tax rate 1:



Press the **CASH/TEND** key to end programming.



The tax status you have entered will display and print on the printer:

```

DEPT.1    T1        0
PROGRAM TERMINATE
01-03-1999    16:36
000014        00
  
```

Basic Operations

Registering Items

1. Enter an amount on the ten key pad. Do not use the decimal key. For example, for \$2.99, enter:

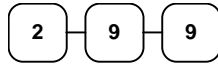

2. Press a department key. For example, press department **1/9**:

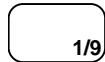

Repeating an Item

3. To register a second item exactly as the first, press the department key a second time. For example, press department **1/9**:

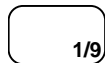

Registering Multiple Items

4. Enter the quantity of items being purchase, press the **@/FOR** key. For example, enter **4** on the numeric key pad and press the **@/FOR** key:



5. Enter an amount on the ten key pad. Do not use the decimal key. For example, for \$1.99, enter:

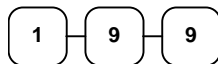

6. Press a department key. For example, press department **2/10**:

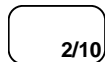

Totaling a Cash Sale

1. Register the items you wish to sell.
2. To display and print the subtotal of the sale including tax, press **SUBTOTAL**:

**SUB
TOTAL**

3. To total a cash sale, press **CASH/TEND**:

**CASH/
TEND**

4. The display will indicate “=” for total, the drawer will open and the receipt will print as in the example on the right.

THANK-YOU CALL AGAIN		
DEPT . 1	T1	\$2 99
DEPT . 1	T1	\$2 99
4 X		@1.99
DEPT . 2		\$7 96
SUBTOTAL		\$14.30
TAXABLE1		\$5.98
TAX1 AMOUNT		\$0.36
CASH		\$14.30
03-01-1999		15:27
000002		00

Tendering a Cash Sale

1. Register the items you wish to sell.
2. To display and print the subtotal of the sale including tax, press **SUBTOTAL**:

**SUB
TOTAL**

3. Enter the amount tendered by the customer. For example, for \$20.00 enter:

2 0 0 0

4. Press **CASH/TEND**:

**CASH/
TEND**

5. The display will indicate “C” for change, the drawer will open and the receipt will print as in the example on the right.

THANK-YOU CALL AGAIN		
DEPT . 1	T1	\$2 99
DEPT . 1	T1	\$2 99
4 X		@1.99
DEPT . 2		\$7 96
SUBTOTAL		\$14.30
TAXABLE1		\$5.98
TAX1 AMOUNT		\$0.36
TOTAL		\$14.30
CASH		\$20.00
CHANGE		\$5.70
03-01-1999		15:27
000004		00

Tendering a Check Sale

1. Register the items you wish to sell.
2. To display and print the subtotal of the sale including tax, press **SUBTOTAL**:

**SUB
TOTAL**

3. Enter the amount of the check tendered by the customer. For example, for \$20.00 enter:

2 0 0 0

4. Press **CHECK**:

CHECK

5. The display will indicate "C" for change, the drawer will open and the receipt will print as in the example on the right.

THANK-YOU CALL AGAIN		
DEPT. 1	T1	\$2 99
DEPT. 1	T1	\$2 99
4 X		@1.99
DEPT. 2		\$7 96
SUBTOTAL		\$14.30
TAXABLE1		\$5.98
TAX1 AMOUNT		\$0.36
TOTAL		\$14.30
CHECK		\$20.00
CHANGE		\$5.70
03-01-1999		15:27
000005		00

Totaling a Charge Sale

1. Register the items you wish to sell.
2. To display and print the subtotal of the sale including tax, press **SUBTOTAL**:

**SUB
TOTAL**

3. Press **CHARGE**:

CHARGE

4. The display will indicate "=" for total, the drawer will open and the receipt will print as in the example on the right.

THANK-YOU CALL AGAIN		
DEPT. 1	T1	\$2 99
DEPT. 1	T1	\$2 99
4 X		@1.99
DEPT. 2		\$7 96
SUBTOTAL		\$14.30
TAXABLE1		\$5.98
TAX1 AMOUNT		\$0.36
CHARGE		\$14.30
03-01-1999		15:27
000006		00

Note: Charge tendering is not allowed.

Advanced Operating Instructions

Clerk Operations

If you wish to use the clerk system, you must first activate the clerk system by setting system option #16. See “System Option Programming” on page 50. You can activate the clerk system for stay down or pop-up mode.

- Stay down means that once a clerk is signed on, the same clerk will remain signed on until a different clerk signs on or the original clerk signs off. A stay down clerk system might be used when only one operator uses the register at a time, and a different operator begins when a work shift is changed.
- Pop-up means that the clerk is automatically signed off at the end of each transaction. Therefore, to begin a transaction, you must first sign a clerk on. A pop-up clerk system might be used in a department store, where several clerks might use the register during the same shift, and clerk sales information is required.

Clerk Sign On

- ◆ To sign on, enter the secret code and press the **CLERK** key, or press the **CLERK** key, then enter the secret code and press the **CLERK** key again.

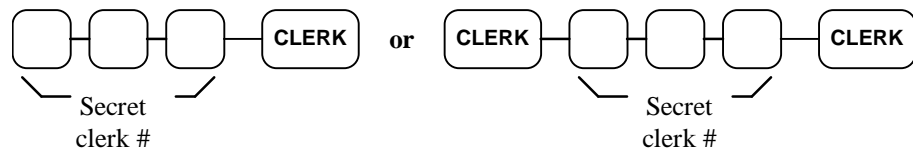

Clerk Sign Off

- ◆ To sign off, enter **0**, press the **CLERK** key.

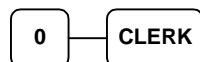

Department Registrations

As you make department registrations, you can follow your entries by viewing the display. The digits marked “DPT” indicate the department used. The digit marked “RPT” counts items as they are repeated.

Open Department

1. Enter an amount on the ten key pad. Do not use the decimal key. For example, for \$2.99, enter:

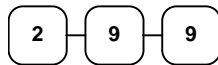

2. Press a department key. For example, press department 1/9:

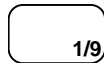

THANK-YOU		
CALL AGAIN		
DEPT. 1	T1	\$2 99
TAXABLE1		\$2.99
TAX1 AMOUNT		\$0.18
CASH		3.17
03-01-1999		15:27
000002		00

Preset Price Department

A preset department registers the price that was previously programmed. See “Department Programming” on page 45 to program preset prices.

1. Press a preset department key. For example, press department 5/13:

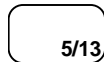

THANK-YOU		
CALL AGAIN		
DEPT. 5		\$1 29
CASH		\$1.29
03-01-1999		15:27
000005		00

Department Repeat Entry

Open or preset price departments may be repeated as many times as necessary by pressing the same department again. (Likewise open or preset PLUs may be repeated by pressing the PLU key again.)

1. Enter an amount on the ten key pad. Do not use the decimal key. For example, for \$2.99, enter:

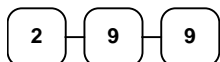

2. Press a department key. For example, press department **1/9**:

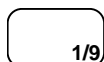

3. To register a second item exactly as the first, press the department key a second time. For example, press department **1/9**:

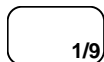

THANK-YOU		
CALL AGAIN		
DEPT .1	T1	\$2 99
DEPT .1	T1	\$2 99
TAXABLE1		\$5 .98
TAX1 AMOUNT		\$0 .36
CASH		\$6 .34
03-01-1999		15 :28
000006		00

Multiplication

When several of the same items are to be entered into the same Department, you can use multiplication. You may enter a quantity up to 4 figures (1 to 9999) using the **@/FOR** key. You may multiply open or preset departments.

1. Enter the quantity of items being purchased, press the **@/FOR** key. For example, enter **4** on the numeric key pad and press the **@/FOR** key:



2. Enter an amount on the ten key pad. Do not use the decimal key. For example, for \$1.99, enter:



- Press a department key. For example, press department **1/9**:

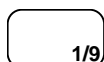

THANK-YOU		
CALL AGAIN		
4 X		@1 .99
DEPT .1	T1	\$7 96
TAXABLE1		\$7 .96
TAX AMOUNT		\$0 .48
SUBTOTAL		\$7 .96
CASH		\$8 .44
03-01-1999		15 :29
000007		00

Department Multiplication With Decimal Point

If you are selling items by weight, or if you are selling yard goods, you can multiply a fraction of a unit.

1. Enter the quantity purchased with the decimal point, press the **@/FOR** key. For example, for 3 $\frac{3}{4}$ pounds of produce, enter:

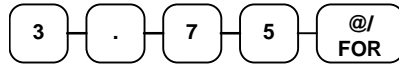

2. Enter an amount on the ten key pad. Do not use the decimal key. For example, if the price is \$.99 per pound, enter:



- Press a department key. For example, press department **1/9**:

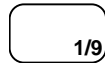

THANK-YOU		
CALL AGAIN		
3.750 X		@0.99
DEPT.1	T1	\$3.71
TAXABLE1		\$3.71
TAX AMOUNT		\$0.22
CASH		\$3.93
03-01-1999		15:30
000008		00

Split Pricing

When items are priced in groups, i.e. 3 for \$1.00, you can enter the quantity purchased and let the register calculate the correct price.

1. Enter the quantity purchased, press the **@/FOR** key. For example, enter:



2. Enter the quantity of the group price, press the **@/FOR** key. For example, if the items are priced 3 for \$1.00, enter:



3. Enter an amount on the ten key pad. For example, if the items are priced 3 for \$1.00, enter:

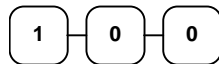

4. Press a department key. For example, press department **1/9**:

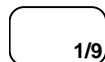

THANK-YOU		
CALL AGAIN		
2/3 X		@1.00
DEPT.1	T1	\$0.67
TAXABLE1		\$0.67
TAX AMOUNT		\$0.04
CASH		\$0.71
03-01-1999		15:31
000009		00

Single Item Department

Single item departments automatically total as a cash sale immediately after registration. Use single item departments for speedy one item sales. For example if you are selling admission tickets, and all ticket sales are one item sales, you can assign open or preset department single item department for ticket sales. After each registration, the drawer will immediately open, and a separate receipt is printed. See "Department Programming" on page 45 to program a single item department.

- 1. Press a single item preset department key. (or enter a price and press a single item open department key.) For example, press department **6/14**:



THANK-YOU	
CALL AGAIN	
DEPT. 6	\$1 29
CASH	3.17
03-01-1999	15:32
000010	00

PLU (Price Look Up) Registrations

PLUs must be programmed before they may be operated. See “PLU (Price Look Up) Programming” on page 66 to program open or preset PLUs.

Open PLU

1. Enter the PLU number, press the **PLU** key.
For example, enter:



2. Enter an amount on the ten key pad. Do not use the decimal key. For example, for \$2.99, enter:

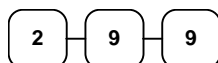

3. Press the **PLU** key again.



THANK-YOU		
CALL AGAIN		
PLU2	T1	\$2 99
TAXABLE1		\$2.99
TAX1 AMOUNT		\$0.18
CASH		3.17
03-01-1999		15:45
000032		00

Preset Price PLU

1. Enter the PLU number, press the **PLU** key.
For example, enter:



THANK-YOU		
CALL AGAIN		
PLU1		\$1 29
CASH		\$1 29
03-01-1999		15:46
000033		00

PLU Repeat Entry

1. Enter the PLU number, press the **PLU** key.
For example, enter:



2. To register a second item exactly as the first, press the PLU key a second time:



THANK-YOU		
CALL AGAIN		
PLU1	T1	\$2 99
PLU1	T1	\$2 99
TAXABLE1		\$5.98
TAX1 AMOUNT		\$0.36
CASH		\$6.34
03-01-1999		15:51
000035		00

PLU Multiplication

When several of the same items are to be entered into the same PLU, you can use multiplication. You may enter a quantity up to 4 figures (1 to 9999) using the @/FOR key. You may multiply open or preset open or preset PLUs.

1. Enter the quantity of items being purchased, press the @/FOR key. For example, enter **4** on the numeric key pad and press the @/FOR key:



2. Enter the PLU number, press the PLU key. For example, enter:



THANK-YOU		
CALL AGAIN		
4 X		@1.99
PLU1	T1	\$7.96
TAXABLE1		\$7.96
TAX AMOUNT		\$0.48
SUBTOTAL		\$7.96
CASH		\$8.44
03-01-1999		15:51
000036		00

PLU Multiplication With Decimal Point

If you are selling items by weight, or if you are selling yard goods, you can multiply a fraction of a unit.

1. Enter the quantity purchased with the decimal point, press the @/FOR key. For example, for 3 ³/₄ pounds of produce, enter:

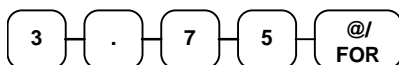

2. Enter the PLU number, press the PLU key. For example, enter:



THANK-YOU		
CALL AGAIN		
3.750 X		@2.99
PLU3	T1	\$11.21
TAXABLE1		\$11.21
TAX AMOUNT		\$0.67
CASH		\$11.88
03-01-1999		15:52
000037		00

Split Pricing PLU

When items are priced in groups, i.e. 3 for \$1.00, you can enter the quantity purchased and let the register calculate the correct price.

1. Enter the quantity purchased, press the @/FOR key. For example, enter:



2. Enter the quantity of the group price, press the @/FOR key. For example, if the items are priced 3 for \$1.00, enter:



3. Enter the PLU number, press the PLU key. For example, enter:



THANK-YOU		
CALL AGAIN		
2/3 X		@2.99
PLU3	T1	\$1.99
TAXABLE1		\$1.99
TAX AMOUNT		\$0.12
CASH		\$2.11
03-01-1999		15:55
000039		00

Shifting or Exempting Tax

Shifting Tax

Taxable Departments and PLUs can be programmed to automatically add the appropriate tax or taxes. Occasionally, you may need to sell a normally taxable item without tax, or a normally taxable item with tax. You can perform this tax shifting with the TAX SHIFT key.

1. Enter the number for the tax you wish to shift. Press **1** to shift tax 1, press **2** to shift tax 2 or press **3** to shift tax 3. Press the **TAX SHIFT** key. For example, shift tax 1:



2. Enter an amount on the ten key pad. Do not use the decimal key. For example, for \$2.99, enter:

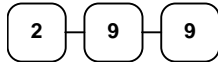

3. Press a department key. For example, press department **1/9**:

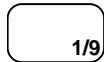

4. If department **1/9** is normally taxable by tax 1, the registration will non-taxable by tax 1, the registration will include tax.

THANK-YOU CALL AGAIN	
DEPT. 1	\$2.99
TAXABLE1	\$2.99
CASH	\$2.99
03-01-1999	15:27
000002	00

Exempting Tax

Occasionally, you may need to exempt tax from an entire sale. For example, you might remove all state and local taxes when you sell to a church or charitable institution.

1. Enter an amount on the ten key pad. Do not use the decimal key. For example, for \$2.99, enter:

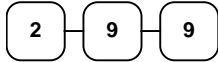

2. Press a taxable department key. For example, press department **1/9**:

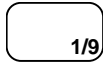

3. Press Subtotal:

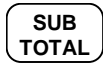

4. Enter the number for the tax you wish to exempt. Press **1** to shift tax 1, press **2** to shift tax 2 or press **3** to shift tax 3. Press the **TAX SHIFT** key. For example, exempt tax 1:



5. Total the sale with **CASH/TEND**, **CHECK**, or **CHARGE**. The sale will not include tax 1.

THANK-YOU		
CALL AGAIN		
DEPT. 1	T1	\$2 99
SUBTOTAL		\$3.17
CASH		\$2.99
03-01-1999		15:28
000045		00

Percent Key (+% and -%) Operations

Use the Percent keys to add a percentage surcharge or subtract a percentage from an item or the subtotal of a sale. You can enter the amount of the percentage before pressing the -% or +% keys, or you can program a preset percentage if you are consistently using the same percentage. Programming determines whether it is possible to enter a percentage when the key is also programmed with a preset percentage. See “+% and -% Key Programming” on page 58 to set a preset percentage.

Preset Percent on a Department or PLU Item

In this example the -% key is preset with a rate of %10.00.

1. Register the discounted item.
2. Press the -% key:

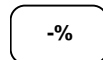

3. The discount is automatically subtracted.

THANK-YOU CALL AGAIN	
DEPT 2	\$10.00
-%	10.000
	-1.00
CASH	\$9.00
03-01-1999	15:51
000031	00

Enter a Percent on a Department or PLU

You can also operate the -% or +% keys by entering the percentage of the discount or surcharge. If necessary, you can enter the percentage with a decimal key (up two 3 digits, i.e. 99.999%).

1. Register the discounted item.
2. Enter the percentage. If you are entering a fraction of a percent, you must use the decimal key. For example, for 33.33% off enter:



3. Press the -% key:

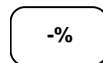

4. The discount is automatically subtracted.

THANK-YOU CALL AGAIN	
DEPT 2	\$10.00
-%	33.333
	-3.33
CASH	\$6.67
03-01-1999	15:52
000032	00

Percent On Sale Total

In this example a surcharge of 15% is applied.

1. Register the items you wish to sell.
2. Press **SUBTOTAL**:

**SUB
TOTAL**

3. Enter the percentage. For example, for 15% enter:

1 5

4. Press the +% key:

+%

5. The surcharge is automatically added.

THANK-YOU	
CALL AGAIN	
DEPT 2	\$10.00
SUBTOTAL	\$10.00
+%	15.000
	\$1.50
CASH	\$11.50
03-01-1999	15:53
000033	00

Return Merchandise Registrations

If you wish to return or refund an item, press Return Merchandise, then re-enter any item you wish. You can return merchandise as part of a sale, or you can return merchandise as a separate transaction and return cash to the customer.

1. To return an item, press **MDSE RTRN**:

**MDSE
RTRN**

2. Enter the price of the item you wish to return, then press the department key where it was registered originally.

2 9 9 2/10

3. Total the sale with **CASH/TEND**, **CHECK**, or **CHARGE**.

THANK-YOU	
CALL AGAIN	
RETURN MDSE	
DEPT 2 T1	-2.99
TAXABLE1	-2.99
TAX1 AMOUNT	-0.18
CASH	-3.17
03-01-1999	15:50
000030	00

Voids and Corrections

Void Last Item

This function corrects the last item entered.

1. Register the item you wish to sell.
2. Press the **VOID** key.

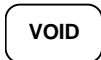

THANK-YOU CALL AGAIN		
DEPT .1	T1	\$2 29
DEPT 2		\$1.29
VOID		
DEPT 2		-1.29
TAXABLE1		\$2.29
TAX1 AMOUNT		\$0.14
CASH		\$2.43
03-01-1999		15:47
000027		00

Void Previous Item

This function allows you to correct an item registered previously in a transaction.

1. Register an item. Then register a second item.
2. To correct the first item, press **CLEAR**, then press **VOID**:



3. Enter the price of the first item, then press the department key where it was registered originally.

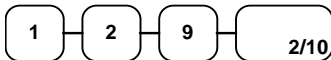

THANK-YOU CALL AGAIN		
DEPT 2		\$1.29
DEPT .1	T1	\$2 29
VOID		
DEPT 2		-1.29
TAXABLE1		\$2.29
TAX1 AMOUNT		\$0.14
CASH		\$2.43
03-01-1999		15:49
000029		00

Cancel

The **CANCEL** key allows you to stop any transaction. Anything registered within the transaction before the **CANCEL** key is pressed is automatically corrected. The **CANCEL** key may be inactivated through programming, see “CANCEL Key Programming” on page 62.

1. Register the items you wish to sell.
2. Press the **CANCEL** key.



THANK-YOU		
CALL AGAIN		
DEPT.1	T1	\$2 29
COUPON		-0.50
CANCEL-----		
03-01-1999		15:46
000026		00

Void Position Operations

You can use the Void control lock position to correct any complete transaction. To correct any transaction:

1. Turn the control lock to the VOID position.
2. Enter the transaction you wish to correct exactly as it was entered originally in the **REG** control lock position. You can enter discounts, voids, returns, tax exemptions or any other function.
3. All totals and counters are corrected as if the original transaction did not take place.

THANK-YOU		
CALL AGAIN		
VOID MODE		
DEPT.1	T1	-2 29
DEPT 2		-1.00
SUBTOTAL		-3.43
TAXABLE1		-2.29
TAX1 AMOUNT		-0.14
CASH		-3.43
03-01-1999		15:46
000026		00

- (Minus) Key Registrations

You can register a negative amount by entering a price, then pressing the - (Minus) key. For example, you can enter bottle returns or coupons using the - (Minus) key.

Note: You can program the minus key so that tax is charged on the gross amount, or on the net amount after the subtraction. See “- (Minus) Key Programming” on page 60.

1. Register the items you wish to sell.
2. Enter the amount you wish to subtract from the sale, for example for a \$.50 coupon, enter:

5 0

3. Press the - (Minus) key.

-

THANK-YOU CALL AGAIN		
DEPT .1	T1	\$2 29
COUPON		-0.50
TAXABLE1		\$2.29
TAX1 AMOUNT		\$0.14
CASH		\$1.93
03-01-1999		15:42
000025		00

No Sale Operations

Open Drawer

The **#/NO SALE** key will open the cash drawer when you have not already started a transaction.

1. Press **#/NO SALE**:



2. The drawer will open and the receipt will print as in the example on the right.

THANK-YOU	
CALL AGAIN	
OPEN DRAWER	
03-01-1999	15:44
000022	00

Non Add Number

You can also use the **#/NO SALE** key to print any number (up to 8 digits) on the printer paper. You can enter the number any time during a transaction. For example, if you wish to record a charge account number, enter the number and press the **#/NO SALE** key before totaling the sale with the **CHARGE** key.

1. Register the items you wish to sell.
2. Enter the number you wish to record, for example enter:



3. Press **#/NO SALE**:



4. Press **CHARGE**:



5. The display will indicate “=” for total, the drawer will open and the receipt will print as in the example on the right.

THANK-YOU	
CALL AGAIN	
DEPT.1 T1	\$2.99
NON ADD NO.	1234
TAXABLE1	\$2.99
TAX1 AMOUNT	\$0.18
CHARGE	\$3.17
03-01-1999	15:41
000023	00

Received On Account Operations

You can use the Received on Account key to accept cash into the cash drawer when you are not actually selling merchandise. For example, use the Received on Account key to accept payments for previously sold merchandise, or record loans to the cash drawer.

1. Enter the amount of cash you are receiving, for example, enter:

2 0 0 0

2. Press **RECD ACCT**:

RECD
ACCT

3. The drawer will open and the receipt will print as in the example on the right.

THANK-YOU CALL AGAIN	
RECEIVED ON	\$20.00
03-01-1999	15:40
000020	00

Paid Out Operations

You can use the **PAID OUT** key to track cash paid out for merchandise or to record loans from the cash drawer.

1. Enter the amount of cash you are paying, for example, enter:

2 0 0 0

2. Press **PAID OUT**:

PAID
OUT

3. The drawer will open and the receipt will print as in the example on the right.

THANK-YOU CALL AGAIN	
PAID OUT	\$20.00
03-01-1999	15:41
000021	00

Totaling and Tendering

Three keys may be used to total and total a sale: **CHECK**, **CHARGE**, **CASH/TEND** key. The **CHECK** and **CASH/TEND** keys can also be used for change calculation.

Subtotaling a Sale

1. Register the items you wish to sell.
2. To display and print the subtotal of the sale including tax, press **SUBTOTAL**:

**SUB
TOTAL**

3. The subtotal will display with “=” indicated in the left digit position of the display.

Totaling a Cash Sale

1. Register the items you wish to sell.
2. To total a cash sale, press **CASH/TEND**:

**CASH/
TEND**

3. The display will indicate “=” for total, the drawer will open and the receipt will print as in the example on the right.

THANK-YOU CALL AGAIN		
DEPT.1	T1	\$2 99
DEPT.1	T1	\$2 99
4 X		@1.99
DEPT.2		\$7 96
SUBTOTAL		\$14.30
TAXABLE1		\$5.98
TAX1 AMOUNT		\$0.36
CASH		\$14.30
03-01-1999		15:27
000002		00

Tendering a Cash Sale

1. Register the items you wish to sell.
2. Enter the amount tendered by the customer.
For example, for \$20.00 enter:

2 0 0 0

3. Press **CASH/TEND**:

CASH/
TEND

4. The display will indicate “C” for change, the drawer will open and the receipt will print as in the example on the right.

THANK-YOU CALL AGAIN		
DEPT . 1	T1	\$2 99
DEPT . 1	T1	\$2 99
4 X		@1.99
DEPT . 2		\$7 96
SUBTOTAL		\$14.30
TAXABLE1		\$5.98
TAX1 AMOUNT		\$0.36
TOTAL		\$14.30
CASH		\$20.00
CHANGE		\$5.70
03-01-1999		15:27
000004		00

Tendering a Check Sale

1. Register the items you wish to sell.
2. Enter the amount tendered by the customer.
For example, for \$20.00 enter:

2 0 0 0

3. Press **CHECK**:

CHECK

4. The display will indicate “C” for change, the drawer will open and the receipt will print as in the example on the right.

THANK-YOU CALL AGAIN		
DEPT . 1	T1	\$2 99
DEPT . 1	T1	\$2 99
4 X		@1.99
DEPT . 2		\$7 96
SUBTOTAL		\$14.30
TAXABLE1		\$5.98
TAX1 AMOUNT		\$0.36
TOTAL		\$14.30
CHECK		\$20.00
CHANGE		\$5.70
03-01-1999		15:27
000005		00

Totaling a Charge Sale

1. Register the items you wish to sell.
2. Press **CHARGE**:

CHARGE

3. The display will indicate “=” for total, the drawer will open and the receipt will print as in the example on the right.

Note: Charge tendering is not allowed.

THANK-YOU CALL AGAIN		
DEPT . 1	T1	\$2 99
DEPT . 1	T1	\$2 99
4 X		@1.99
DEPT . 2		\$7 96
SUBTOTAL		\$14.30
TAXABLE1		\$5.98
TAX1 AMOUNT		\$0.36
CHARGE		\$14.30
03-01-1999		15:27
000006		00

Check Cashing

Check cashing means exchanging cash for a check. Normally, this function is not allowed. If you wish to allow check cashing, you must set system option #15 to a value of **1**. See “System Option Programming” on page 50.

1. Enter the amount of the check tendered by the customer. For example, for \$20.00 enter:

2 0 0 0

2. Press **CHECK TEND**:

**CHECK
TEND**

3. The display will indicate “C” for change, the drawer will open and the receipt will print as in the example on the right.

THANK-YOU CALL AGAIN	
CHECK	\$20.00
CASH	-20.00
03-01-1999	15:33
000013	00

Split Tender

Split tendering means paying for one sale by different payment methods. For example, a \$20.00 sale could be split so \$10.00 is paid in cash, and the remaining \$10.00 is charged. If necessary, you can make several different payments.

Note: If a portion of a sale is to be charged, the charge payment must be entered last.

1. Register the items you wish to sell.
2. Enter the amount of cash tendered by the customer. For example, enter \$10.00 and press **CASH/TEND**:

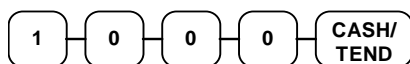

3. The display will indicate “=” and \$10.00, indicating the amount still due. The drawer will not open. Press **CHARGE** to charge the remaining amount:

CHARGE

4. The display will indicate “=” for total, the drawer will open and the receipt will print as in the example on the right.

THANK-YOU	
CALL AGAIN	
DEPT . 2	\$20 00
SUBTOTAL	\$20.00
TOTAL	\$20.00
CASH	\$10.00
TOTAL	\$10.00
CHARGE	\$10.00
03-01-1999	15:34
000014	00

Post Tender

Post tendering means computing change after the sale has been totaled and the drawer is open. This feature is useful when a customer changes the amount of the tender or the clerk becomes confused counting change manually. Normally, this function is not allowed. If you wish to allow post tendering, you must set system option #14 to a value of 1. See “System Option Programming” on page 50.

1. Register the items you wish to sell.
2. Press **CASH/TEND**:

**CASH/
TEND**

3. The display will indicate “=” for total, the drawer will open and the receipt will print as in the example on the right.
4. Enter the amount of the tender, Press **CASH/TEND**:

**2 0 0 0 CASH/
TEND**

5. The display will indicate “C” for change and display \$17.88 change due.

THANK-YOU CALL AGAIN		
DEPT.1	T1	\$2.00
SUBTOTAL		\$2.12
TAXABLE1		\$2.00
TAX1 AMOUNT		\$0.12
CASH		\$2.12
03-01-1999		15:36
000015		00

Currency Conversion

If you normally accept currency from a neighboring nation, you can program the *SAM4s ER-350II* to convert the subtotal of a sale to the equivalent cost in the foreign currency. To do this, you need to program the conversion factor. For example, if the US dollar (home currency) is worth 1.3720 Canadian dollars (foreign currency), the conversion factor is 1.3720. See “Programming Currency Exchange Rates” on page 63 to set a conversion rate.

1. Register the items you wish to sell.
2. Press **SUBTOTAL** to display the amount due in your home currency:

**SUB
TOTAL**

3. To convert the amount due to an equivalent value in foreign currency, press **C/CONV**:

C/CONV

4. Enter the amount of the foreign currency tender, Press **CASH/TEND**:

1 0 0 0 **CASH/
TEND**

5. The display will indicate “C” for change and display \$5.17 change due. **The change due is computed in home currency!**

THANK-YOU CALL AGAIN		
DEPT.1	T1	\$2.00
SUBTOTAL		\$2.12
TAXABLE1		\$2.00
TAX1 AMOUNT		\$0.12
FOREIGN AMT		@10.00
CHANGE RATE		#1.3720
HOME AMT.		\$7.29
CHANGE		\$5.17
03-01-1999		15:38
000016		00

Add Check

Use the **ADD CHECK** key when you wish to issue a receipt, but not yet pay for the sale. For example, one person may wish to pay for two guest checks at a restaurant, or one person may pay for two admissions, where separate receipts are required for each person.

1. Register the items you wish to sell on the first receipt.
2. Press **ADD CHECK** to issue a receipt for the items:

**ADD
CHECK**

3. Register the items you wish to sell on the next receipt, press **ADD CHECK** to issue a receipt for the items:

**ADD
CHECK**

4. Press **SUBTOTAL** to display the amount due for both of the receipts:

**SUB
TOTAL**

5. Total or tender the sale with **CASH/TEND**, **CHECK** or **CHARGE**

THANK-YOU CALL AGAIN		
DEPT. 1	T1	\$2.00
TAXABLE1		\$2.00
TAX1 AMOUNT		\$0.12
ADD CHECK		\$2.12
03-01-1999		15:39
000017		00

THANK-YOU CALL AGAIN		
DEPT. 2		\$5.00
ADD CHECK		\$5.00
03-01-1999		15:39
000018		00

THANK-YOU CALL AGAIN		
TAXABLE1		\$2.00
TAX1 AMOUNT		\$0.12
CASH		\$7.12
03-01-1999		15:39
000018		00

Receipt On/Off and Receipt on Request

When a receipt is not normally issued, you can turn the receipt function on or off.

If the receipt is off, you can still issue a receipt after the sale has been completed. Normally, this function is not allowed. If you wish to allow after sale receipts, you must set system option #17 to a value of 1. See “System Option Programming” on page 50.

To Turn the Receipt Off

- ◆ With the control lock in the **REG** position, press **PAID OUT**:

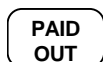

To Turn the Receipt On

- ◆ With the control lock in the **REG** position, press **PAID OUT** again:

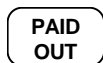

Printing a Receipt after the Sale

- ◆ After the sale has been totaled, but before the next transaction is started, press **CASH/TEND**:



Note: Because receipt memory is limited, when a sale has more than 30 items or more than 3 tenders, the receipt after sale can not print all items. A row of dots is printed indicating the receipt is incomplete.

Advanced Programming Instructions

Department Programming

Programming Department Status

There are two parts to department programming. Department status is set here. Depending on whether you select open or preset department status in this section, you can also program either the open department entry limit or the preset department price. See “Programming Department Entry Limit or Price” on page 48.

Use this section to program the following status options:

- Set negative departments that subtract from the sale, rather than normal positive departments which add to the sale.
- Enforce the entry of a non-adding number before the department entry. See “Non Add Number” on page 34 for operation sequences.
- Disable the departments, so that entries are not allowed.
- Choose Open or Preset departments. Open departments accept amount entries. Use open departments to enter different priced items into the same category. Preset departments automatically register a preprogrammed price when the department key is pressed. Use preset departments to register an individual item quickly and accurately. For example, cigarette packs or food items can be assigned to departments as presets.

When you select preset departments, you can also decide if the department can also accept open entries. This option is referred to as “preset override”.

- Set single item departments which automatically total as a cash sale immediately after the department entry. Single item departments are used to speed up one item sales.
- Select a tax status to determine whether sales tax is automatically added.

Unless otherwise programmed, departments are positive, open, not taxable, not single item departments, and accept unlimited amounts (up to 7 digit entry). Therefore, it is not necessary to program departments you wish to be open, positive, non-taxable, not single item, with no entry limit.

Programming Department Status

1. Turn the control lock to the **PGM** position.
2. Decide if you want a negative, enforced non-add entry, or disabled department. If you do not want any of these department options, enter **0**. If you wish to select any of these options, complete the table below by adding the status digits for each option. Enter the resulting digit.

Department is Negative	Yes = 1 No = 0		+
Enforce Non-Add Entry	Yes = 2 No = 0		+
Department is Disabled	Yes = 4 No = 0		+
			=

3. Decide if you want a preset or single item department. If you do not want any of these department options, enter **0**. If you wish to select any of these options, complete the table below by adding the status digits for each option. Enter the resulting digit.

Department is Preset	Yes = 1 No = 0		+
Allow Preset Override	Yes = 2 No = 0		+
Department is Single Item	Yes = 4 No = 0		+
			=

4. Complete the tax status table below by adding the status digits for each tax. Then enter the resulting tax status code.

Taxable by Rate 1?	Yes = 1 No = 0		+
Taxable by Rate 2?	Yes = 2 No = 0		+
Taxable by Rate 3?	Yes = 4 No = 0		+
			=

5. Press the **@/FOR** key.
6. Press the department key you wish to program, or press **DEPT SHIFT** and the appropriate department if you are programming departments 9-16.
7. Repeat steps 2 through 6 for each department you wish to program.
8. Press the **CASH/TEND** key to end programming.

Department Status Programming Flowchart

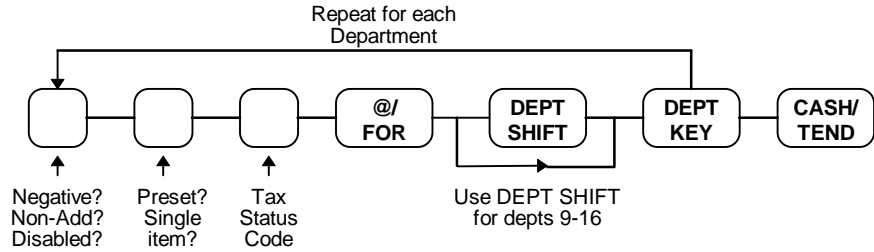

Department Status Programming Examples

For example, set:

- department 1 open, taxable by rate 1
- department 4 preset, taxable by rate 2
- department 9 negative, preset, taxable by rate 1 & 2

To set Department 1, enter:



To set Department 4, enter:



To set Department 9, enter:

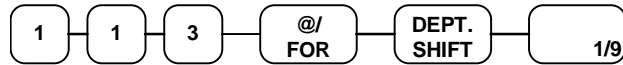

Press the **CASH/TEND** key to end programming.



The status you have entered will display and print on the printer:

DEPT. 1	1
DEPT. 4	12
DEPT. 9	113
PROGRAM TERMINATE	
01-03-1999	16:36
000014	00

Programming Department Entry Limit or Price

Note: Open departments are automatically assigned a 7 digit entry limit. You do not need to program this section for open departments, unless you wish to set a different limit.

If you are programming a open department:

- You can limit errors by setting the maximum amount that may be entered into a department.

If you are programming a preset department:

- You can set the preset price. The price you program here is the amount that is automatically registered when the department key is pressed.

Programming a Department Entry Limit or Price

1. Turn the control lock to the **PGM** position.
2. If the department is preset, enter the preset price, up to seven digits (01 to 1234567). (It is not necessary to enter proceeding zeros. For example enter \$1.00 as 100.)

OR,

If the department is open, enter the entry limit you wish to set.

3. Press the department key you wish to program, or press **DEPT SHIFT** and the appropriate department if you are programming departments 9-16.
4. Repeat from step 2 above for each department you wish to set.
5. Press the **CASH/TEND** key to end programming.

Department Entry Limit or Price Programming Flowchart

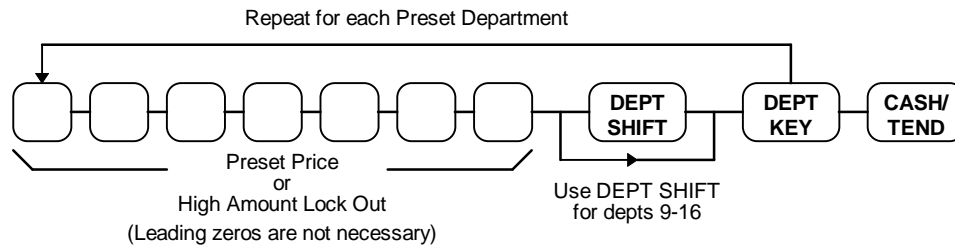

Department Entry Limit or Price Programming Examples

For example, set:

- department 1 open, with a entry limit of \$50.00
- department 4 preset for \$2.50
- department 9 preset for \$0.99

To set Department 1, enter:



To set Department 3, enter:

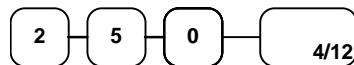

To set Department 9, enter:

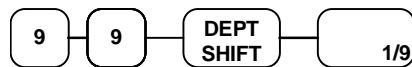

Press the **CASH/TEND** key to end programming.



The tax status you have entered will display and print on the printer:

DEPT. 1	\$50.00
DEPT. 4	\$2.50
DEPT. 9	\$0.99
PROGRAM TERMINATE	
01-03-1999	18:56
000049	00

System Option Programming

Twenty system options are provided so that you can configure the *SAM4s ER-350II* to your exact requirements. Refer to the “System Option Table” on page 52 to review the system options. Read each option carefully to determine if you wish to make any changes.

NOTE: Because after clearing memory all options settings are automatically set to 0, and because your most likely option selections require a status setting of 0, you do not need to program this section unless you wish to change the default status.

Programming a System Option:

1. Turn the control lock to the **PGM** position.
2. Enter the option number of the system option you wish to change. Press the **RECD ACCT** key.
3. Enter the number representing the status you have selected. Press the **PAID OUT** key.
4. Repeat from step 3 for each system option you wish to change.
5. Press the **CASH/TEND** key to end programming.

System Option Flowchart

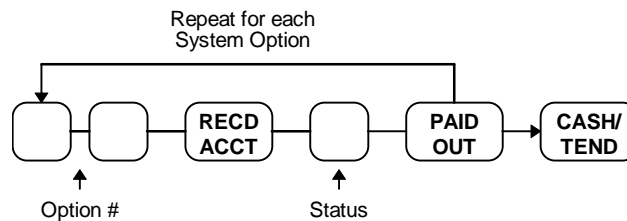

System Option Programming Examples

Set the following options

- Option 15: Allow check cashing.
- Option 20: Enforce cash or check tender at totaling.

To set option 16:

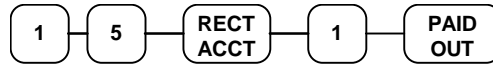

To set option 20:



Press the **CASH/TEND** key to end programming.



System Option Table

NOTE: Shaded areas are the default settings, in other words, the shaded area indicates the way the register is automatically set up.

Option No.	SYSTEM OPTION	STATUS	
1	Print the grand total on X,/Z report.	YES = 0	
		NO = 1	
2	Print the gross total on X,/Z report.	YES = 0	
		NO = 1	
3	Reset the consecutive number counter after a Z report.	NO = 0	
		YES = 1	
4	Reset the Z counter after Z report.	NO = 0	
		YES = 1	
5	Skip totals with zero value on X,Z report.	YES = 0	
		NO = 1	
6	Reset the grand total after a Z report.	NO = 0	
		YES = 1	
7	Print the subtotal when pressed.	YES = 0	
		NO = 1	
8	Cash must be declared before X/Z report.	NO = 0	
		YES = 1	
9	Allow X reports	YES = 0	
		NO = 1	
10	Decimal point position	0 = none	
		1 = 1 place	
		2 = 2 places	
		1 = 3 places	
11	Select a method for tax printing:		
	Print Taxable Totals.	Print tax amounts separately.	0
	Print Taxable Totals.	Print only total of all taxes.	1
	Print Taxable Totals.	Do not print tax amounts.	2
	Do not print Taxable Total.	Print tax amounts separately.	3
	Do not print Taxable Total.	Print only total of all taxes.	4
	Do not print Taxable Total.	Do not print tax amounts.	5

Option No.	SYSTEM OPTION	STATUS	
12	Rounding method for percentage key and tax.	Round up at 0.50	0
		Always Round up	1
		Always Round down	2
13	Rounding method for decimal multiplication and split pricing.	Round up at 0.50	0
		Always Round up	1
		Always Round down	2
14	Allow Post Tender.	NO = 0	
		YES = 1	
15	Allow Check Cashing.	NO = 0	
		YES = 1	
16	Select clerk option:		
	Clerk function inactive.		0
	Allow clerk function. Clerk stay down mode.		1
	Allow clerk function. Clerk pop up mode.		2
17	Allow receipt after sale.	NO = 0	
		YES = 1	
18	Print Currency Symbol:		
	Print "\$"		0
	Print "."		1
	Do not print currency symbol.		2
19	Enforce cash or check tender at totaling.	NO = 0	
		YES = 1	

Advanced Tax Programming

Use the instructions in this chapter only if you wish to determine tax program entries yourself. See “Programming Tax” on page 13 to enter a simple tax rate.

Important Note: After you have entered your tax program, test for accuracy by entering several transactions of different dollar amounts. Carefully check to make sure the tax charged by the cash register matches the tax on the printed tax chart for your area. As a merchant, you are responsible for accurate tax collection. If the cash register is not calculating tax accurately, contact your local SAM4s Dealer for assistance.

Tax Rate Programming

You can program up to three separate taxes on the *SAM4s ER-350II*. Set tax rate(s) here.

- If you are entering a tax table, see “Tax Table Programming” on page 56 to enter the tax break points.
- If you are entering a Canadian Goods and Services Tax (GST), use tax rate 3 for the GST tax, and use tax rates 1 and/or 2 for any other provincial tax or taxes.

Programming Tax Rates and Status

1. Turn the control lock to the **PGM** position.
2. If the tax is a percentage rate, enter it with a decimal. (0.000-99.999). It is not necessary to enter proceeding zeros. For example, for 6%, enter 06.000 or 6000.
3. For the type of tax, enter:

0	if the tax is a percentage added to the sale (normal add on tax)
1	if the tax is a percentage value added tax (VAT; calculated as part of the sale)

4. Enter **0** here for all taxes, unless if you are programming tax 3 as a Canadian GST. If the tax is a Canadian GST. Enter:

1	if the GST (tax 3) is taxable by rate 1
2	if the GST (tax 3) is taxable by rate 2
3	if the GST (tax 3) is taxable by rates 1 and 2

5. Enter:

1	to set tax rate 1
2	to set tax rate 2
3	to set tax rate 3

6. Press the **TAX SHIFT** key.

7. Press the **CASH/TEND** key to end programming.

Tax Rate Programming Flowchart

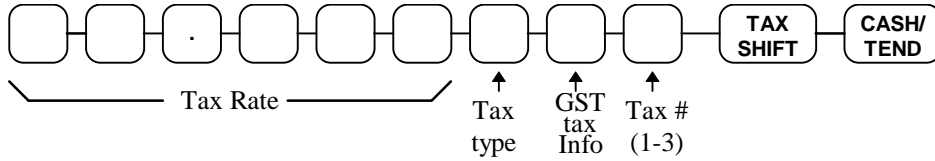

Tax Rate Examples

If tax 1 is 6 percent, enter:

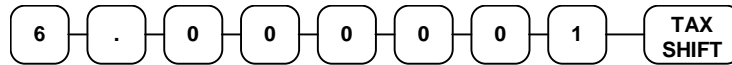

If tax 3 is 8 percent Canadian GST and the GST is taxable, enter:

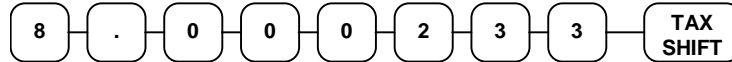

Press the **CASH/TEND** key to end programming.



The rates you have entered will display and print on the printer:

```

TAX1 STATUS          00
TAX1 RATE            6.000
TAX3 STATUS          23
TAX3 RATE            8.000
PROGRAM TERMINATE
01-03-1999           16:36
000013                00
00
  
```

Tax Table Programming

In some cases, a tax that is entered as a percentage does not follow exactly the tax charts that apply in your area (even if the tax chart is based on a percentage). In these cases, we recommend that you enter your tax using tax table programming. This method will match tax collection exactly to the break points of your tax table.

Before programming, obtain a copy of the tax table you wish to program. You will need the printed tax table if you wish to determine the break point entries yourself.

Note: You can enter up to 47 break points.

Determining Break Point Entries

1. Refer to the “Tax Table Programming Example - Illinois 6% Tax Table” on page 57 to help with this exercise.
2. Calculate the break point differences by subtracting the high side of the previous range from the high side of the dollar range.
3. Examine the pattern of break point differences to determine when the break points begin to repeat. Mark the beginning break points that do not fit a pattern as “non-repeat breaks.” Mark the break points that are repeating in a pattern as “repeat breaks.”

Programming a Tax Table

1. Turn the control lock to the **PGM** position.
2. Enter the number of the tax you are programming (**1**, **2**, or **3**), press the **TAX SHIFT** key.
3. Enter the maximum amount that is not taxed, press the **TAX SHIFT** key.
4. Enter the first tax amount charged, press the **TAX SHIFT** key.
5. For each non-repeat break point, enter the high side from the sale dollar range and press the **TAX SHIFT** key.
6. Press the **CHECK** key.
7. For each repeat break point, enter the high side from the sale dollar range and press the **TAX SHIFT** key.
8. Press the **CASH/TEND** key to end the tax table program.

Tax Table Programming Example - Illinois 6% Tax Table

<u>Tax Charged</u>	<u>Sale Dollar Range</u>	<u>Break point Differences</u>	
\$0.00	\$0.00 - \$0.10		
\$0.01	\$0.11 - \$0.21	11	Non-Repeat
\$0.02	\$0.22 - \$0.38	17	
\$0.03	\$0.39 - \$0.56	18	
\$0.04	\$0.57 - \$0.73	17	
\$0.05	\$0.74 - \$0.91	18	Repeat
\$0.06	\$0.92 - \$1.08	17	
\$0.07	\$1.09 - \$1.24	16	
\$0.08	\$1.25 - \$1.41	17	
\$0.09	\$1.42 - \$1.58	17	
\$0.10	\$1.59 - \$1.74	16	
\$0.11	\$1.75 - \$1.91	17	
\$0.12	\$1.92 - \$2.08	17	
\$0.13	\$2.09 - \$2.24	16	
\$0.14	\$2.25 - \$2.41	17	

To enter the program for the Illinois 6% tax table:

1. Enter **1** (for tax #1), press the **TAX SHIFT** key.
2. Enter **1 0** (the maximum amount that is not taxed), press the **TAX SHIFT** key.
3. Enter **1** (the first tax amount charged), press the **TAX SHIFT** key.
4. Enter **2 1** (non-repeat break point), press the **TAX SHIFT** key.
5. Enter **3 8** (non-repeat break point), press the **TAX SHIFT** key.
6. Enter **5 6** (non-repeat break point), press the **TAX SHIFT** key.
7. Enter **7 3** (non-repeat break point), press the **TAX SHIFT** key.
8. Enter **9 1** (non-repeat break point), press the **TAX SHIFT** key.
9. Press the **CHECK** key.
10. Enter **1 0 8** (repeat break point), press the **TAX SHIFT** key.
11. Enter **1 2 4** (repeat break point), press the **TAX SHIFT** key.
12. Enter **1 4 1** (repeat break point), press the **TAX SHIFT** key.
13. Press the **CASH/TEND** key to complete the tax program.

+% and -% Key Programming

There are two percentage keys on the keyboard: +% and -%. The +% key applies a surcharge. The -% key applies a discount. Without any further programming, you can apply a discount or surcharge to an individual item or to the subtotal of a sale by entering a percentage and pressing the +% or -% key. This program allows you to:

- decide to calculate any taxes *before* or *after* the percentage is applied
- set a preset percentage for the +% or -% key
- if a preset percentage is set, decide if you wish to also allow a percentage to be entered
- inactivate the key

Programming the +% or -% Key

1. Turn the control lock to the **PGM** position.
2. Enter the percentage rate you wish to preset, or **0** if you only wish to enter the percentage. Press the +% or -% key, depending on which key you are programming. Enter the percentage rate in a 5-digit format without the decimal. For example, enter **50000** for 50% or enter 33 1/3 % as **33.333**.
3. To decide if tax is calculated before or after the percentage is applied, complete the table below by adding the status digits for each tax. Then enter the resulting tax status code.

Calculate Rate 1 after the discount/surcharge?	Yes = 1 No = 0		+
Calculate Rate 2 after the discount/surcharge?	Yes = 2 No = 0		+
Calculate Rate 3 after the discount/surcharge?	Yes = 4 No = 0		+
			=

4. Enter:

0	If you wish to allow the operator to also enter a percentage (override).
1	If you do not wish to allow the operator to also enter a percentage (override).
2	If you wish the key to be inactive.

5. Press the **CASH/TEND** key to end programming.

+% or -% Key Programming Flowchart

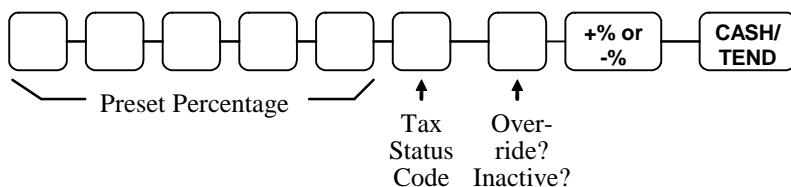

+% or -% Key Programming Example

Set the -% (discount) Key preset for 50% and so that tax 1 is calculated after the discount is applied and override is allowed. Enter:

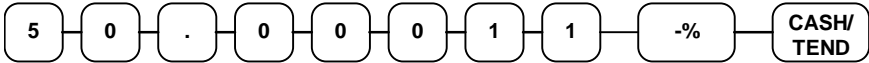

- (Minus) Key Programming

The - (**Minus**) key is used to enter the amount of a coupon that is subtracted from the sale.

- The - (**Minus**) key can be programmed to be taxable or non-taxable. In other words, when you are subtracting a coupon, you can calculate sales tax on the net or the gross cost of the item. If the - (**Minus**) key is taxable, you will calculate sales tax on the net cost of the item. If the - (**Minus**) key is non-taxable, you will calculate sales tax on the gross cost of the item.
- You can also program limit errors by setting the maximum amount that may be entered into the - (**Minus**) key. For example, setting a 3 digit limit means the maximum you can enter is \$9.99. This is referred to as the High Digit Lock Out, or HDLO.

Programming the - (Minus) Key

1. Turn the control lock to the **PGM** position.
2. Enter the High Digit Lock Out (entry limit) digit from the table below. (Enter **0** for no limit.)

HDLO	Limits
1	.01 - .09
2	.01 - .99
3	.01 - 9.99
4	.01 - 99.99
5	.01 - 999.99
6	.01 - 9999.99
0	.01 - 99999.99

3. To decide if tax is calculated before or after the percentage is applied, complete the table below by adding the status digits for each tax. Then enter the resulting tax status code.

Calculate Rate 1 after the Minus (-) key entry?	Yes = 1 No = 0		+
Calculate Rate 2 after the Minus (-) key entry?	Yes = 2 No = 0		+
Calculate Rate 3 after the Minus (-) key entry?	Yes = 4 No = 0		+
			=

4. Enter:

0	for active minus key
1	for inactive minus key

5. Press the - (**Minus**) key.
6. Press the **CASH/TEND** key to end programming.

Minus (-) Key Programming Flowchart

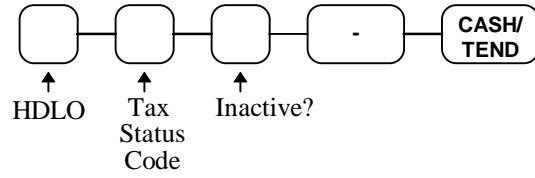

Minus (-) Key Programming Example

Set the Minus (-) key with a three digit HDLO (\$9.99) and so that tax 1 is calculated after the Minus (-) key amount is entered. (In other words, tax is calculated on the net cost of the item.) Enter:

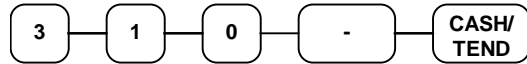

CANCEL Key Programming

The **CANCEL** key can be made inactive. Normally the key is active, however, you may wish to inactivate it for security reasons.

Programming the CANCEL Key

1. Enter:
 - 0 to activate the **CANCEL** key
 - 1 to inactivate the **CANCEL** key
2. Press the **CANCEL** key.
3. Press the **CASH/TEND** key to end programming.

Cancel Key Programming Flowchart

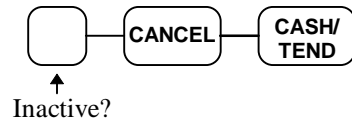

Cancel Key Programming Example

To inactivate the **CANCEL** key, enter:



Currency Conversion

If you normally accept currency from a neighboring nation, you can program the *SAM4s ER-350II* to convert the subtotal of a sale to the equivalent cost in the foreign currency. To do this, you need to program the conversion factor. For example, if the US dollar (home currency) is worth 1.3720 Canadian dollars (foreign currency), the conversion factor is 1.3720.

Note: Foreign currency exchange rates may be stated as “foreign currency in dollars”, or “dollars in foreign currency”. Use the rate stated in “dollars in foreign currency” when you are programming this section.

Programming Currency Exchange Rates

1. Turn the control lock to the **PGM** position.
2. Enter the exchange rate of up to 5 digits (do not enter the decimal point).
3. Enter a number from 0 to 4 to indicate the decimal position.
4. Press the **C/CONV** key.
5. Press the **CASH/TEND** key to end programming.

Currency Exchange Rate Programming Flowchart

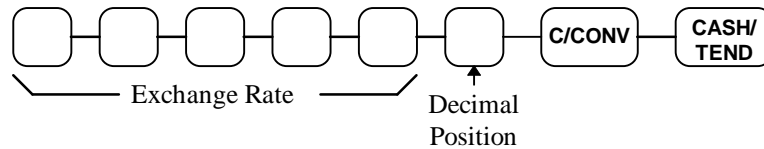

Currency Exchange Rate Programming Example

The US dollar (home currency) is worth 1.3720 Canadian dollars (foreign currency).

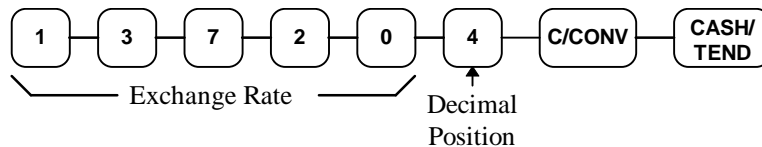

Programming Clerks

If you wish to use the clerk system, you must first activate the clerk system by setting system option #16. See “System Option Programming” on page 50. You can activate the clerk system for with a stay down or pop-up mode.

- Stay down means that once a clerk is signed on, the same clerk will remain signed on until a different clerk signs on or the original clerk signs off. A stay down clerk system might be used when only one operator uses the register at a time, and a different operator begins when a work shift is changed.
- Pop-up means that the clerk is automatically signed off an the end of each transaction. Therefore, to begin a transaction, you must first sign a clerk on. A pop-up clerk system might be used in a department store, where several clerks might use the register during the same shift, and clerk sales information is required.

With the clerk system activated, you can operate up to 10 clerks. The clerk registering a transaction is printed on the bottom of the receipt to indicate clerks 1 through 10. For example:

03-01-1999	15:27
000002 CLERK 1	00

See “Clerk Operations” on page 19 for clerk sign on and sign off sequences.

Programming a Clerk Code

The clerk code consists of a three digit secret number, followed by the digit representing the number of the clerk.

1. Turn the control lock to the **PGM** position.
2. Set system option #16 to a value or **1** or **2** (for with a stay down or pop-up mode). See “System Option Programming” on page 50.
3. *If programming a secret code for the first time:*
Enter the clerk number (1-10), press the **CLERK** key.
To change an existing secret code:
Enter the secret code, press the **CLERK** key
4. Enter a three digit secret code, press the **@/FOR** key
5. Repeat from step 3 for each clerk you wish to program.
6. Press the **CASH/TEND** key to end programming.

Clerk Programming Flowchart

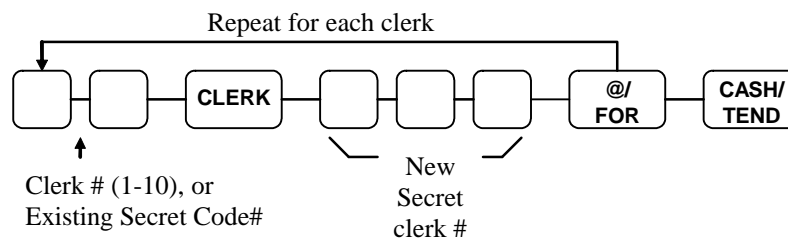

Clerk Programming Example

To set Clerk #5 with a code of **5 6 7**, enter:

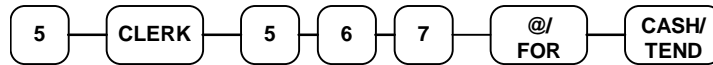

Printing Clerk Codes:

If you need to verify clerk codes:

1. Turn the control lock to the **PGM** position.
2. Press the **CLERK** key.
3. The printer will print as in the example below:

THANK-YOU	
CALL AGAIN	
CLERK 1	1
CLERK 2	2
CLERK 3	3
CLERK 4	4
CLERK 5	567
CLERK 6	6
CLERK 7	7
CLERK 8	8
CLERK 9	9
CLERK 10	10
03-01-1999	15:39
000017	00

PLU (Price Look Up) Programming

The *SAM4s ER-350II* offers 300 PLUs (Price Look Ups) as a standard feature. Like departments PLUs (Price Look Ups) may be *open* or *preset*.

- Preset PLUs are used to register preset items. The most significant difference between a preset department and a preset PLU is the method of registration. While preset departments are registered by simply pressing the department key, preset PLUs are registered by entering the PLU number and pressing the PLU key.

There are many possible uses for preset PLUs. Since there are many more PLUs than departments, you may use PLUs when you wish to accurately price and count a larger group of items. Possible uses include: menu items in a restaurant or items (such as cigarettes) that you wish to inventory.

- Use open PLUs when you wish to enter different priced items into a larger number of categories.

Programming PLU Status

There are two parts to PLU programming. PLU status is set here. Depending on whether you select open or preset PLU status in this section, you can also program either the open PLU entry limit or the preset PLU price. See “Programming PLU Entry Limit or Price” on page 69.

Use this section to program the following status options:

- Set negative PLUs that subtract from the sale, rather than normal positive PLUs which add to the sale.
- Enforce the entry of a non-adding number before the PLU entry. See “Non Add Number” on page 34 for operation sequences.
- Disable the PLUs, so that entries are not allowed.
- Choose Open or Preset PLUs.
- Set single item PLUs which automatically total as a cash sale immediately after the department entry. Single item departments are used to speed up one item sales.
- Select a tax status to determine whether sales tax is automatically added.

Programming PLU Status

1. Turn the control lock to the **PGM** position.
2. Enter the number of the PLU you wish to program (1-300), press the **PLU** key.
3. Decide if you want a negative, enforced non-add entry, or disabled PLU. If you do not want any of these options, enter **0**. If you wish to select any of these options, complete the table below by adding the status digits for each option. Enter the resulting digit.

PLU is Negative	Yes = 1 No = 0		+
Enforce Non-Add Entry	Yes = 2 No = 0		+
PLU is Disabled	Yes = 4 No = 0		+
			=

4. Decide if you want a preset or single item PLU. If you do not want any of these options, enter **0**. If you wish to select any of these options, complete the table below by adding the status digits for each option. Enter the resulting digit.

PLU is Preset	Yes = 1 No = 0		+
PL:U is Single Item	Yes = 2 No = 0		+
			=

5. Complete the tax status table below by adding the status digits for each tax. Then enter the resulting tax status code.

Taxable by Rate 1?	Yes = 1 No = 0		+
Taxable by Rate 2?	Yes = 2 No = 0		+
Taxable by Rate 3?	Yes = 4 No = 0		+
			=

6. Press the department key that you want this PLUs' sales added to, or press **DEPT SHIFT** and the appropriate department if you are selecting departments 9-16.
7. Repeat steps 2 through 6 for each PLU you wish to program.
8. Press the **CASH/TEND** key to end programming.

PLU Status Programming Flowchart

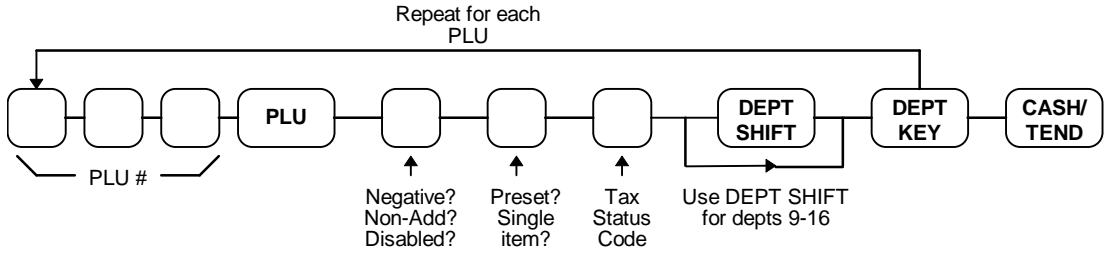

PLU Status Programming Examples

For example, set:

- PLU #1 preset, not single item, taxable by rate 1, with sales reported to department 2.
- PLU #30 preset, single item, taxable by rate 2, with sales reported to department 4.
- PLU #6 open, not single item, non-taxable, with sales reported to department 9.

To set PLU 1, enter:



To set PLU 30, enter:

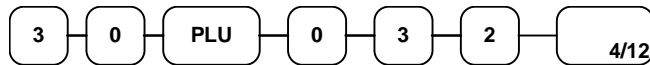

To set PLU 6, enter:

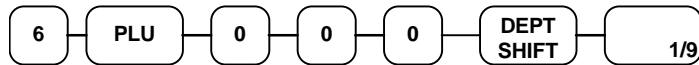

Press the **CASH/TEND** key to end programming.



The status you have entered will display and print on the printer:

PLU1		11
DEPT. 2		
PLU30	T1	32
DEPT. 4		
PLU6		0
DEPT. 9		
PROGRAM TERMINATE		
01-03-1999		16:36
000014		00

Programming PLU Entry Limit or Price

Note: Open PLUs are automatically assigned a 7 digit entry limit. You do not need to program this section for open PLUs, unless you wish to set a different limit.

If you are programming a open PLU:

- You can limit errors by setting the maximum amount that may be entered into a PLU.

If you are programming a preset PLU:

- You can set the preset price. The price you program here is the amount that is automatically registered when the PLU is entered.

Programming a PLU Entry Limit or Price

1. Turn the control lock to the **PGM** position.
2. Enter the number of the PLU you wish to program (1-300), press the **PLU** key.
3. If the PLU is preset, enter the preset price, up to seven digits (01 to 1234567). (It is not necessary to enter proceeding zeros. For example enter \$1.00 as 100.)

OR

If the PLU is open, enter the highest amount that may be entered into the PLU.

4. Press the **@/FOR** key.
5. Repeat from step 2 above for each PLU you wish to program.
6. Press the **CASH/TEND** key to end programming.

PLU Entry Limit or Price Programming Flowchart

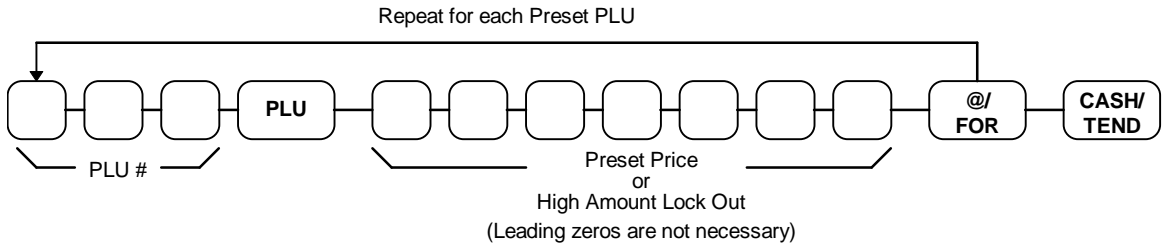

PLU Entry Limit or Price Programming Examples

For example, set:

- PLU 1 with a preset price of \$1.99
- PLU 30 with a preset price of \$10.00
- PLU 6 with a entry limit of \$5.00

To set PLU 1, enter:



To set PLU 30, enter:



To set PLU 6, enter:



Press the **CASH/TEND** key to end programming.



The tax status you have entered will display and print on the printer:

PLU1	T1	@1.99
PLU30	T2	@10.00
PLU6		@5.00
PROGRAM TERMINATE		
01-03-1999		18:56
000049		00

Setting a Register Number

You can program a two digit register number that will print on the lower right corner of each transaction. If you are using more than one cash register, the register number can be used to identify the register where the transaction was entered.

03-02-1996	02:38
000026	99

Register Number

To set a register identification number:

1. Turn the control lock to the **PGM** position.
2. Enter register number and press the **#/NS** key:

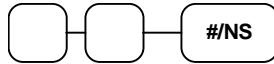

3. Press the **CASH/TEND** key to end programming.



Programming Descriptions

Customer Logo

Without otherwise programming, the customer logo will print a two line message at the top of each receipt:

THANK-YOU CALL AGAIN

If you wish you can replace this message with your own custom message. Your message can be up to 5 lines long.

Programming a Custom Preamble/Postable Message:

1. Turn the control lock to the **PGM** position.
2. Press the **@/FOR** key.
3. Refer to the “Code Table” on page 76 and enter the two digits that represent each character you wish. You can enter up to 26 character codes for each line.
4. Press the **@/FOR** key.
5. Enter the two digit number that represents the line of the message you wish to program:

Preamble Message	Postamble Message
11 = 1 st Line	21 = 1 st Line
12 = 2 nd Line	22 = 2 nd Line
13 = 3 rd Line	23 = 3 rd Line
14 = 4 th Line	24 = 4 th Line
15 = 5 th Line	25 = 5 th Lin
16 = 6 th Line	26 = 6 th Line

6. Press the **CHECK TEND** key
7. Repeat from step 2 for each line you are programming.
8. Press the **CASH/TEND** key to end programming.

Logo Programming Flowchart

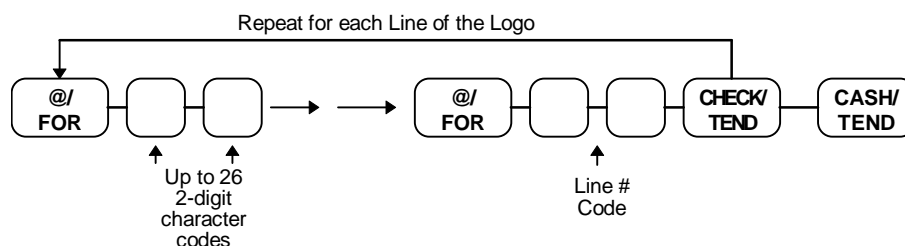

Logo Programming Example

Program the first line of the logo to say "GENERAL STORE"

1. Turn the control lock to the **PGM** position.
2. Press the **@/FOR** key.
3. To center the message on the receipt, enter six space characters: **7 0 7 0 7 0 7 0 7 0**
7 0.
4. Enter the codes representing the text "GENERAL STORE": **2 6 2 4 3 3 2 4 3 7 2 0 3 1**
7 0 3 8 3 9 3 4 3 7 2 4.
5. Press the **@/FOR** key.
6. Enter **1 1**, press the **CHECK TEND** key.
7. Press the **CASH/TEND** key to end programming.

Department Descriptor

Without otherwise programming, each department will print the department number for registrations and reporting. For example, the receipt will look like this:

DEPT . 1	T1	\$2.99
DEPT . 7	T1	\$1.99

If you wish you can each department descriptor with a custom descriptor, up to 10 characters in length. For example, you could program your own descriptors like this:

GROCERY	T1	\$2.99
MEAT	T1	\$1.99

Programming a Department Descriptor

1. Turn the control lock to the **PGM** position.
2. Press the **@/FOR** key.
3. Refer to the “Code Table” on page 76 and enter the two digits that represent each character you wish. You can enter up to 10 character codes for each department.
4. Press the **@/FOR** key.
5. Press the department key you wish to program, or press **DEPT SHIFT** and the appropriate department if you are programming departments 9-16.
6. Repeat from step 2 for each department you are programming.
7. Press the **CASH/TEND** key to end programming.

Department Descriptor Programming Flowchart

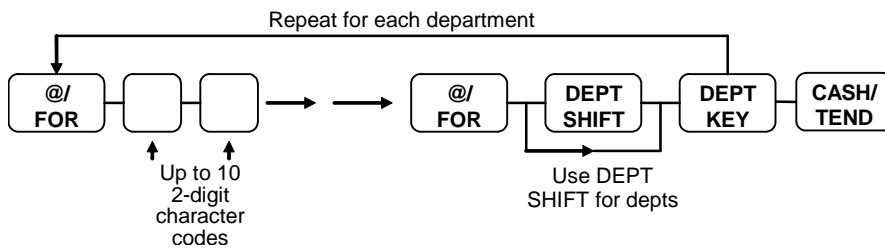

Department Descriptor Programming Example

Program the department 1 descriptor to say “GROCERY”

1. Turn the control lock to the **PGM** position.
2. Press the **@/FOR** key.
3. Enter the codes representing the text “GROCERY”: **2 6 3 7 3 4 2 2 2 4 3 7 4 4**.
4. Press the **@/FOR** key.
5. Press the Department **1/9** key

PLU Descriptor

If you are using PLUs, the PLU descriptor print the PLU code unless you choose to program a custom descriptor. For example, the receipt will look like this:

PLU1	T1	\$2.99
PLU23	T1	\$1.99

If you wish you can each department descriptor with a custom descriptor, up to 10 characters in length. For example, you could program your own descriptors like this:

CIGARETTE	T1	\$2.99
APPLES	T1	\$1.99

Programming a PLU Descriptor

1. Turn the control lock to the **PGM** position.
2. Press the **@/FOR** key.
3. Refer to the “Enter the PLU code, press the **PLU** key.
4. Code Table” on page 75 and enter the two digits that represent each character you wish. You can enter up to 10 character codes for each PLU.
5. Press the **@/FOR** key.
6. Enter the PLU number, press the **PLU** key.
7. Repeat from step 2 for each department you are programming.
8. Press the **CASH/TEND** key to end programming.

PLU Descriptor Programming Flowchart

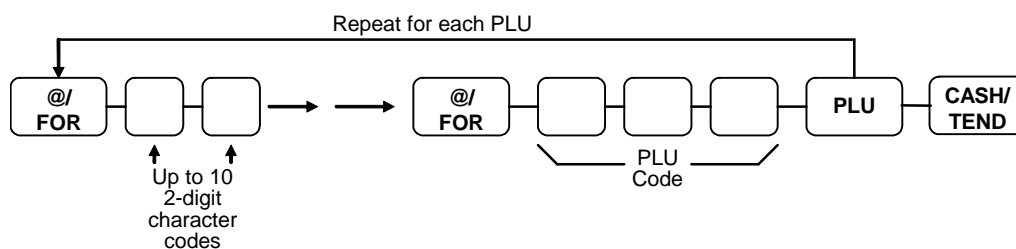

PLU Descriptor Programming Example

Program the descriptor for PLU 1 to say “APPLES”

1. Turn the control lock to the **PGM** position.
2. Press the **@/FOR** key.
3. Enter the codes representing the text “APPLES”: **2 0 3 5 3 5 3 1 2 4 3 8**.
4. Press the **@/FOR** key.
5. Enter the PLU code, press the **PLU** key.

Code Table

Using the Code Table

1. Find the character you wish to print.
2. Find the first entry digit for the character by following the column to the top of the table.
3. Find the second entry digit for the character by following the row to the left margin of the table.

For example the code for A is **20** and the code for Z is **45**.

		First Entry						
		1	2	3	4	5	6	7
Second Entry	0	0	A	K	U	•	!	SPACE
	1	1	B	L	V	/	"	
	2	2	C	M	W	:	%	^
	3	3	D	N	X	;	'	~
	4	4	E	O	Y	<	(\
	5	5	F	P	Z	=)	{
	6	6	G	Q	@	>	*	}
	7	7	H	R	&	?	+	_
	8	8	I	S	#	[,	.
	9	9	J	T	\$]	-	DBL WIDTH

Setting Receipt/Journal Status

The printer can be set to generate customer receipts, or print a sales journal. In the receipt mode, the printer will print the logo and feed the paper a sufficient length so that a receipt can be torn off. In the journal mode, there is no additional paper feeding between transactions. The default state of this program is the RECEIPT status.

To change the printer status from receipt to journal, or from journal to receipt:

1. Turn the control lock to the **X** position.
2. Enter 9999 on the numeric keypad and press the **PAID OUT** key.

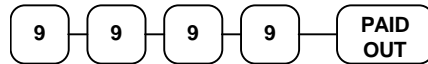

Printing a Programming Report

You can generate a printed report of all the programming options.

1. Turn the control lock to the **PGM** position.
2. Press the **CASH/TEND** key to print the program report.

Program Report Example:

		THANK-YOU CALL AGAIN	
Department Status ->	DEPT.1		70
Department Price or Limit ->			\$0.00
	DEPT.2		70
			\$0.00
	DEPT.3		70
			\$0.00
(Department Status and Price/Limit is listed for each department)	.		
	.		
	.		
	DEPT.16		70
			\$0.00
Tax 1 Status ->	TAX1 STATUS		00
Tax 1 Rate ->	TAX1 RATE		0.000
Tax 2 Status ->	TAX2 STATUS		00
Tax 2 Rate ->	TAX2 RATE		0.000
Tax 3 Status ->	TAX3 STATUS		00
Tax 3 Rate ->	TAX3 RATE		0.000
Percentage Discount Key Status ->	-% STATUS		0
Percentage Discount Key Rate ->	-% RATE		0.000
Percentage Surcharge Key Status ->	+% STATUS		0
Percentage Surcharge Key Rate ->	+% RATE		0.000
Minus (-) Key Status ->	- STATUS		0
Currency Conversion Exchange Rate ->	CHANGE RATE		#0
Decimal Position ->	DECIMAL		0
System Option Value ->	OPTION1		0
System Option Value ->	OPTION2		0
System Option Value ->	OPTION3		0
	.		
(System Option Value is listed for each option)	.		
	.		
System Option Value ->	OPTION20		0
PLU Status & Department ->	PLU1	011 DEPT.4	
PLU Price ->		T1	\$1.00
(PLU Status and Price is listed for each PLU that is programmed)	.		
	.		
	.		
Date/Time ->	03-11-1999		16:03
Transaction Counter/Register Number ->	000066		00

Reports

Report Summary

There are two basic types of reports: "X", or read-only and "Z", or read & reset to zero. Some reports are available in both types.

The following table summarizes the reports available on the *SAM4s ER-350II*:

Report	Control Lock Position	Key
Financial	X or Z	CASH/ TEND
Period-to-Date Financial	X or Z	CHARGE
Hourly Sales	X or Z	X/TIME
All PLU	X or Z	PLU
Clerk	X or Z	CLERK
String Report (Financial, PLU, Time and Clerk reports in sequence)	Z	SUB TOTAL
From/To PLU	X	
Cash in Drawer	X	SUB TOTAL
Check in Drawer	X	CHECK TEND

Running a Report

1. Find the report you wish to run from the table on the previous page.
2. Turn the control lock to the **X** or the **Z** position.
3. Press the appropriate key for the report you wish to run.

Cash-In-Drawer Declaration

Cash-In-Drawer Declaration is an optional feature that forces you to count the drawer and declare the drawer count before a report can be run. By forcing the operator to declare, without knowledge of the expected drawer totals, you are assured that all cash will be deposited. System option #8 must be set to a value of **1** to enforce cash declaration. See "System Option Programming" on page 50 to program system options.

Declaring Cash

1. Turn the control lock to the **X** position.
2. Enter the amount of the cash counted, press the **SUBTOTAL** key:

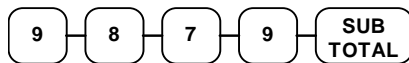

3. The printer will print the declared amount, the cash-in-drawer total from the cash register and compute the difference
4. Proceed to run the report you wish to print.

THANK-YOU	
CALL AGAIN	
INPUT AMOUNT	\$98.79
CASH IN DRAWER	
	\$92.29
DIFFERENCE	\$6.50
03-01-1999	15:57
000041	00

Note: You must run a report after declaring cash before registering any new transactions.

Report Samples

Financial Report

Note: This sample report is shown with items of zero value listed on the report. Your report may only show totals with values other than zero, depending on the setting for system option #5.

		THANK-YOU CALL AGAIN	
Report Name ->		< DAILY REPORT >	
Report Type/Reset (Z) Counter	X		1
Department Activity Counter ->	DEPT.1		18
Department Sales Total ->	T1		\$33.03
	DEPT.2		1
			\$0.07
	DEPT.3		4
			\$50.99
	DEPT.4		2
			\$3.50
	DEPT.5		0
			\$0.00
	DEPT.6		0
			\$0.00
	DEPT.7		1
			\$20.99
	.		
	.		
	.		
	DEPT.16		0
			\$0.00

	+DEPT TTL		26
			\$108.58
	-DEPT TTL		0
			\$0.00
	ADJST DEPT TTL		26
			\$108.58

(Department Counters and Totals are listed for each department)

Continued on the next page . . .

Total of non-taxable sales ->	NONTAX TTL	
Taxable sales for tax rate 1 ->	TAXABLE1	\$33.04
Tax 1 amount collected ->	TAX AMOUNT	\$1.98
Taxable sales for tax rate 2 ->	TAXABLE2	\$0.00
Tax 2 amount collected ->	TAX AMOUNT	\$0.00
Taxable sales for tax rate 3 ->	TAXABLE3	\$0.00
Tax 3 amount collected ->	TAX AMOUNT	\$0.00
Activity count for discount key ->	-%	0
Dollar amount of discounts ->		\$0.00
Activity count for surcharge key ->	+%	0
Dollar amount of surcharges ->		\$0.00
Activity count for -(MINUS) key ->	-%	0
Dollar amount of -(MINUS) ->		\$0.00
Net Sales total ->	NET TOTAL	\$110.57
TAX 1 credited on negative sales ->	CREDIT TAX1	\$0.00
TAX 2 credited on negative sales ->	CREDIT TAX2	\$0.00
TAX 3 credited on negative sales ->	CREDIT TAX3	\$0.00
Count of Return Merchandise items ->	RETURN MDSE	1
Total of Return Merchandise ->		-10.00
Count of VOID key activity ->	VOID KEY	0
Total of VOID key activity ->		\$0.00
# of VOID key position transactions ->	VOID MODE	0
Dollar amount of VOID key position ->		\$0.00
# of canceled transactions ->	CANCEL	0
Amount of canceled transactions ->		\$0.00
Gross Sales Total	GROSS TTL	\$120.57
# of Cash sales ->	CASH	6
Dollar amount of Cash sales ->		\$60.59
# of Check sales ->	CHECK	2
Dollar amount of Check sales ->		\$19.99
# of Charge sales ->	CHARGE	1
Dollar amount of Charge sales ->		\$29.99
# of Rec'd on Account transactions ->	RECEIVED ON	2
Total of Rec'd on Accounts ->		\$30.99
# of Paid Out transactions ->	PAID OUT	1
Total of Paid Out transactions ->		\$10.00

Continued on the next page . . .

Foreign Currency Total ->	CURRENCY TOTAL		
		\$0.00	
Cash in drawer amount ->	CASH IN DRAWER		\$81.58
Check in drawer amount ->	CHECK IN DRAWER		\$19.99
Count of no sales ->	NO SALE COUNT	0	
Customer Count ->	CUSTOMER COUNT	9	

Non-resettable Grand Total ->	GRAND TOTAL	\$12474.83	
Date/Time ->	03-11-1999	2:03	
Transaction Counter/Register Number ->	000089	00	

Hourly Sales Report

The Hourly sales report lists the number of transaction and their dollar total for each hour of the day.

	THANK-YOU CALL AGAIN
Report Name ->	< TIME REPORT >
Report Type/Reset (Z) Counter	X 1
Time Period Activity Counter ->	10:00 7
Time Period Sales Total ->	\$7.59
	11:00 1
(Counters and Totals are listed for each time period)	\$346.67
	12:00 9
	\$110.57

Activity count of all time periods ->	CNT TOTAL 17
Total of all time periods ->	TOTAL \$474.83
Date/Time ->	03-11-1999 12:03
Transaction Counter/Register Number ->	000091 00

PLU Report

The PLU report lists the activity and sale total for each PLU.

	THANK-YOU CALL AGAIN	
Report Name ->	< PLU REPORT >	
Report Type/Reset (Z) Counter	X	1
PLU Activity Counter ->	PLU1	1
PLU tax status/PLU price or limit ->	T1	@1.99
Reporting Dept/PLU Sales Total ->	DEPT.2	\$1.99
	PLU30	1
(PLU Counters and Totals are listed for each PLU)	T2	@10.00
	DEPT.4	\$10.00

Activity count of all PLUs ->	CNT TOTAL	417
Total of all PLUs ->	TOTAL	\$12474.83
Date/Time ->	03-11-1999	2:03
Transaction Counter/Register Number ->	000089	00

Clerk Report

If you are using a clerk system, the clerk report is available. (See "System Option Programming" on page 50 and set option #16 to a value of **1** or **2** if you wish to use the clerk system.)

	THANK-YOU CALL AGAIN
Report Name ->	< CLERK REPORT >
Report Type/Reset (Z) Counter	X 1
Total sales for the clerk ->	•CLERK 1 \$1.06
Number of no sales performed ->	NO SALE CNT. 0
Customer Count for the clerk ->	CUSTOM. CNT 1
	•CLERK 2 \$7.92
(Totals are listed for each CLERK)	NO SALE CNT. 0
	CUSTOM. CNT 9

Total count of all No Sales ->	NO SALE CNT. 0
Total count of all customers ->	CUSTOM. CNT 10
	TOTAL \$8.98
Date/Time ->	03-11-1999 2:03
Transaction Counter/Register Number ->	000089 00

Cash-in-Drawer Report

Run a Cash-in-Drawer report to quickly verify the amount of cash that should be in the cash drawer.

	THANK-YOU CALL AGAIN
Report Name ->	< CASH-IN-DRAWER >
Cash in drawer amount ->	CASH-IN-DRAWER \$81.58
Date/Time ->	03-11-1999 2:03
Transaction Counter/Register Number ->	000097 00

Check-in-Drawer Report

Run a Check-in-Drawer report to quickly verify the amount of checks that should be in the cash drawer.

	THANK-YOU CALL AGAIN
Report Name ->	< CHECK-IN-DRAWER >
Check in drawer amount ->	CHECK-IN-DRAWER \$19.00
Date/Time ->	03-11-1999 2:14
Transaction Counter/Register Number ->	000101 00

System Balancing

Department Sales Total

+	+DEPT TTL (Add All Positive Departments)
-	-DEPT TTL (Add All Negative Departments)
=	ADJST DEPT TTL

Net Total

+	ADJST DEPT TTL
+	TAX1 AMOUNT
+	TAX2 AMOUNT
+	TAX3 AMOUNT
+	+% (Surcharge Total)
-	-% (Discount Total)
-	- (Minus Key Total)
=	NET TTL

Gross Total

+	NET TTL
+	RETURN MDSE
+	VOID KEY
-	+% (Surcharge Total)
+	-% (Discount Total)
+	- (Minus Key Total)
=	GROSS TTL

Grand Total

+	Yesterdays Grand Total
+	Gross Total
=	GRAND TOTAL

Manual Revision Record

Edition	Date published	Revison contents
V1.0	5/26/2006	Integrated Payment Appendix added
V1.1	1/05/2006	Added Postable Message Programming Information
V1.2	3/14/2007	Dept/PLU descriptors 10 characters, not 12
V1.2	6/25/2007	Added "E11" Error Message: Compulsory Tender, p.5
V1.4	4/03/2009	Corrected % key override programming (p58); added "Change Secret Clerk Number" (p64)
V1.5	10/06/2009	Added Manufacturer Precaution Statements
V1.6	10/19/2010	Correcte % key program sequence (do not use decimal) p58