

SPS-2000

Your Account No.: _____

TOUCH SCREEN ECR

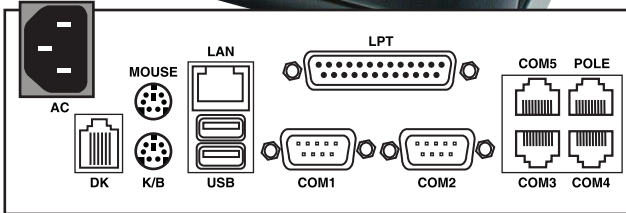

Cable Catalog



CRS, Incorporated • 800-333-4949 • www.crs-usa.com

© 2011, CRS Inc. • Prices effective February 1, 2011

SPS-2000 Cable Configurations

PC Polling/Communication

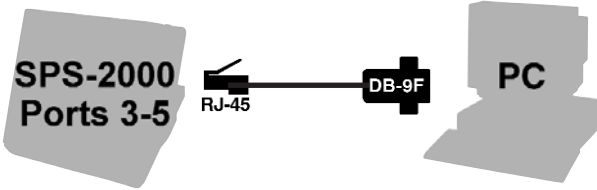

ECR RJ-45		PC DB-9F	
DCD	1	1	DCD
DSR	2	2	RXD
TXD	3	3	TXD
RXD	4	4	DTR
RTS	5	5	GND
CTS	6	6	DSR
GND	7	7	RTS
DTR	8	8	CTS

CRS Part No. 522124 – 5 Feet

PC Polling/Communication

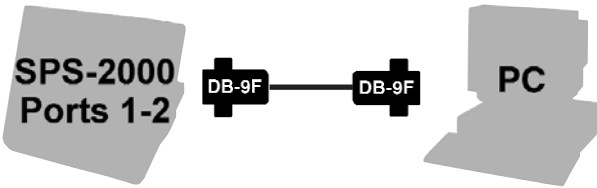

ECR DB-9F		PC DB-9F	
DCD	1	1	DCD
RXD	2	2	RXD
TXD	3	3	TXD
DTR	4	4	DTR
GND	5	5	GND
DSR	6	6	DSR
RTS	7	7	RTS
CTS	8	8	CTS
VCC	9	9	RI

CRS Part No. 522120 – 5 Feet

SPS-2000 Cable Configurations

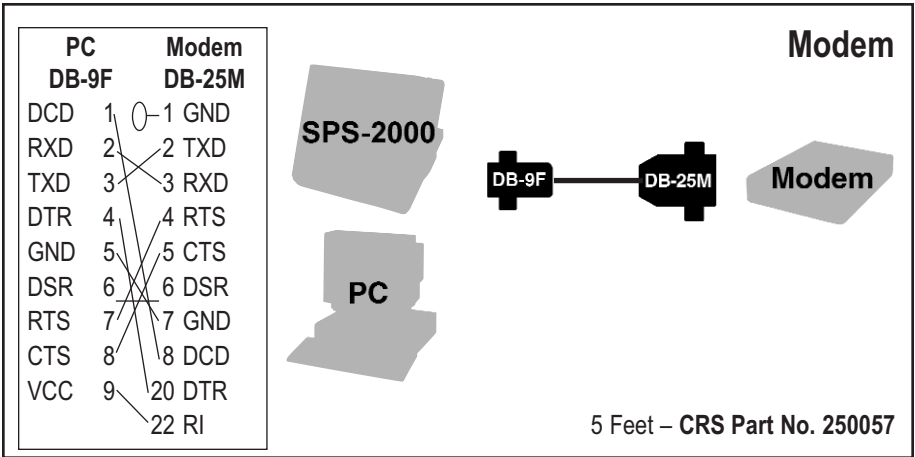
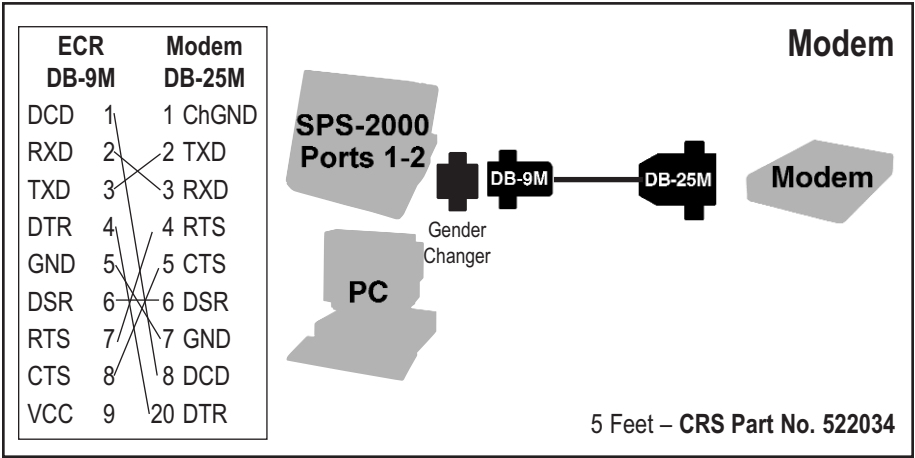
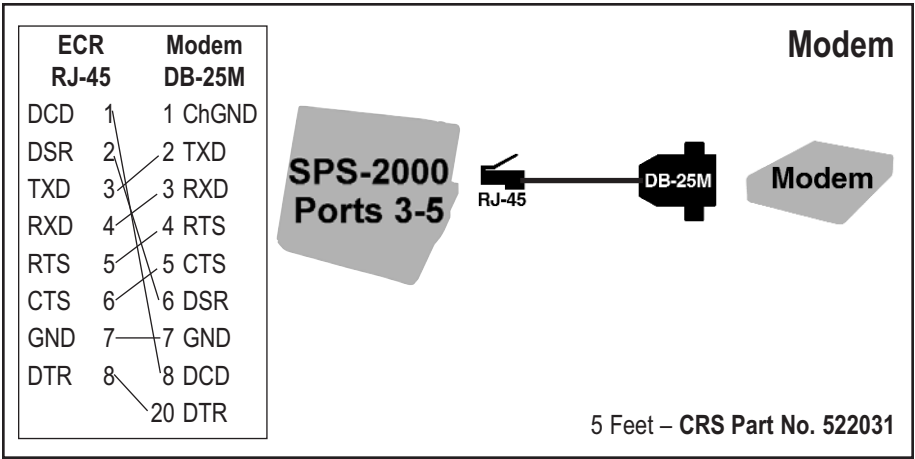

SPS-2000 Cable Configurations

Printer

SPS-2000 Ports 3-5 **RJ-45** **DB-25M** **Other POS Printer**

ECR RJ-45	Printer DB-25M
DCD 1	0-1 ChGND
DSR 2	2 TXD
TXD 3	3 RXD
RXD 4	4 RTS
RTS 5	5 CTS
CTS 6	6 DSR
GND 7	7 GND
DTR 8	8 DCD
	20 DTR

CRS Part No. 522030 – 5 Feet

Printer

SPS-2000 Ports 1-2 **DB-9F** **DB-25M** **Other POS Printer**

ECR DB-9F	Printer DB-25M
DCD 1	0-1 ChGND
RXD 2	2 TXD
TXD 3	3 RXD
DTR 4	4 RTS
GND 5	5 CTS
DSR 6	6 DSR
RTS 7	7 GND
CTS 8	8 DCD
VCC 9	20 DTR

CRS Part No. 522070 – 5 Feet

SPS-2000 Cable Configurations

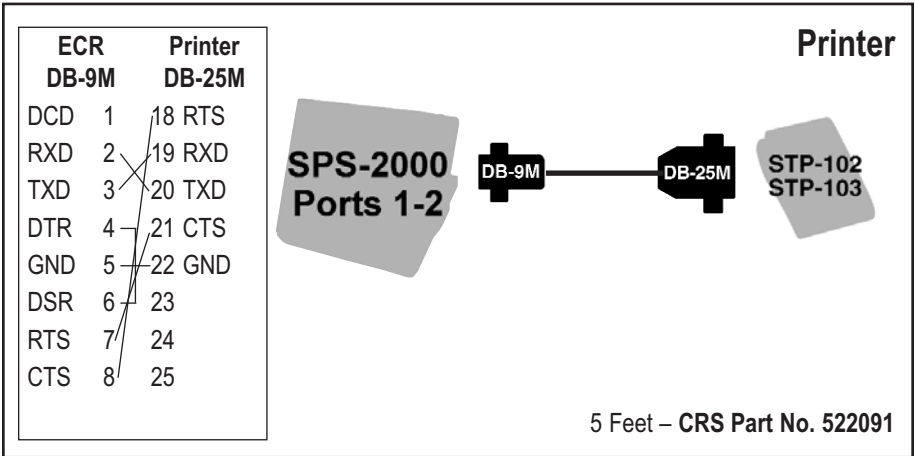
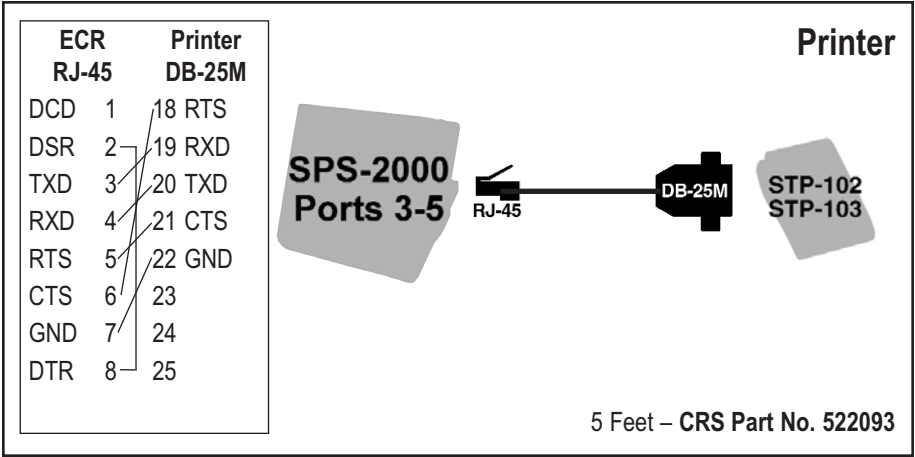

SPS-2000 Cable Configurations

Printer

SPS-2000 Ports 1-2 — DB-9F — RJ-45 — Ellix 10 Printer

ECR DB-9F	Printer RJ-45
N.C. 1	1 +VCC
RXD 2	2 DSR
TXD 3	3 TXD
DTR 4	4 RXD
SGND 5	5 RTS
DSR 6	6 CTS
RTS 7	7 GND
CTS 8	8 DTR
N.C. 9	9 RI
FGND	FGND

CRS Part No. 522122 – 5 Feet

Printer

SPS-2000 Ports 3-5 — RJ-45 — DB-25M — Ellix 20 Printer
Bixelon SRP Printer

ECR RJ-45	Printer DB-25M
DCD 1	1 ChGND
DSR 2	2 TXD
TXD 3	3 RXD
RXD 4	4 RTS
RTS 5	5 CTS
CTS 6	6 DSR
GND 7	7 GND
DTR 8	8 DCD
	20 DTR

CRS Part No. 522115 – 5 Feet

Printer

SPS-2000 Ports 1-2 — DB-9F — DB-25M — Ellix 20 Printer
Bixelon SRP Printer

ECR DB-9F	Printer DB-25M
DCD 1	1 ChGND
RXD 2	2 TXD
TXD 3	3 RXD
DTR 4	4 RTS
GND 5	5 CTS
DSR 6	6 DSR
RTS 7	7 GND
CTS 8	8 DCD
VCC 9	20 DTR

CRS Part No. 522087 – 5 Feet

SPS-2000 Cable Configurations

EPSON DIE-P202 Pole Display

ECR RJ-45	Pole Disp DB-9M
+Vcc 1	1
DSR 2	2 RXD
TXD 3	3
RXD 4	4
RTS 5	5 GND
CTS 6	6
GND 7	7
DTR 8	8 DTR

SPS-2000
Ports 3-5

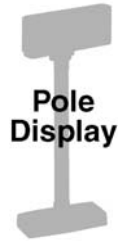

N/A

EPSON DIE-P202 Pole Display

ECR DB-9F	Pole Disp DB-9M
DCD 1	1
RXD 2	2 RXD
TXD 3	3
DTR 4	4
GND 5	5 GND
DSR 6	6
RTS 7	7 DTR
CTS 8	8
+Vcc 9	

SPS-2000
Ports 1-2



N/A

ICD-2002 Pole Display

ECR RJ-45	Pole Disp DB-9M
DCD 1	1
DSR 2	2 TXD
TXD 3	3 RXD
RXD 4	4
RTS 5	5 GND
CTS 6	6 DSR
GND 7	7
DTR 8	8

SPS-2000
Ports 3-5

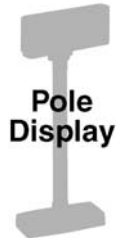

5 Feet – CRS Part No. 522063

SPS-2000 Cable Configurations

ICD-2002 Pole Display

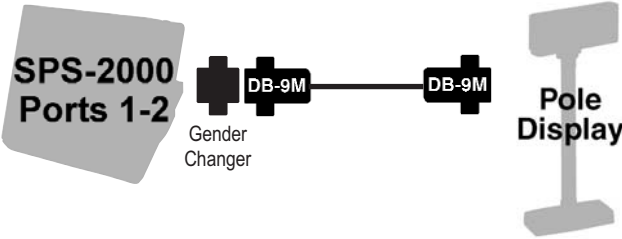

CRS Part No. 522062 – 5 Feet

ECR	Pole Disp
DB-9M	DB-9M
DCD 1	1
RXD 2	2 TXD
TXD 3	3 RXD
DTR 4	4
GND 5	5 GND
DSR 6	6 DSR
RTS 7	7
CTS 8	8

Coin Dispenser



N/A

ECR	Coin Disp
RJ-45	RJ-45
DTR 1	1
DSR 2	2
TXD 3	3
RXD 4	4
RTS 5	5 TXD
CTS 6	6 RXD
GND 7	7 SG
CD 8	8

Coin Dispenser

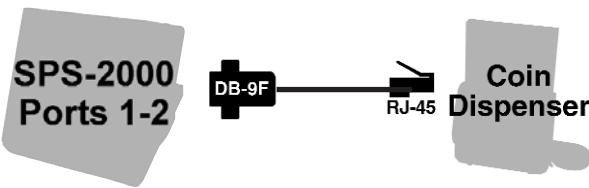

N/A

ECR	Coin Disp
DB-9F	RJ-45
DCD 1	1
RXD 2	2
TXD 3	3
DTR 4	4
GND 5	5 TXD
DSR 6	6 RXD
RTS 7	7 SG
CTS 8	8
VCC 9	

SPS-2000 Cable Configurations

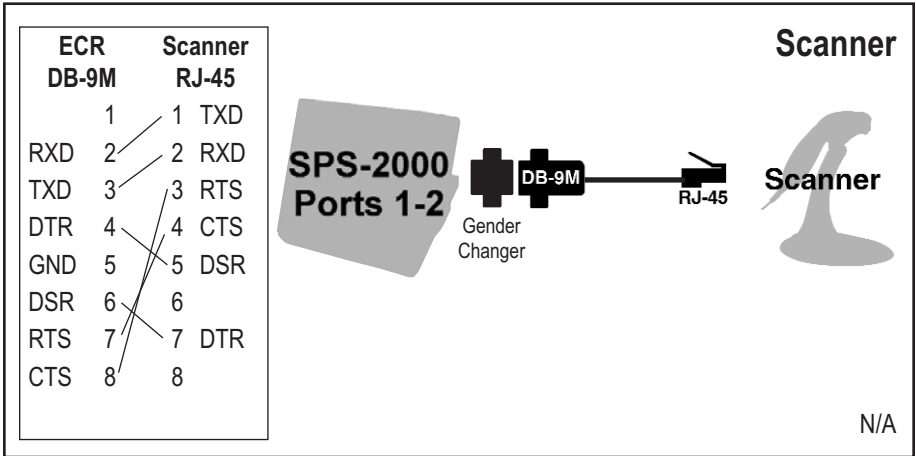
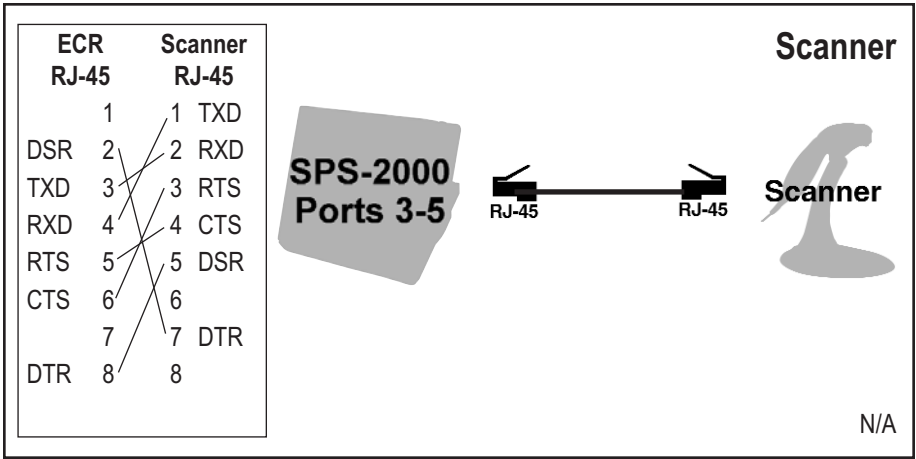

SPS-2000 Cable Configurations

POS 30+ / 60+ Scale

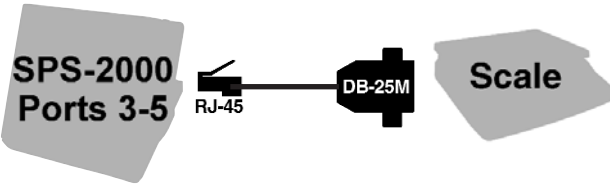

CRS Part No. 522030 – 5 Feet

ECR RJ-45	Scale DB-25M
DCD 1	0-1 ChGND
DSR 2	2 TXD
TXD 3	3 RXD
RXD 4	4 RTS
RTS 5	5 CTS
CTS 6	6 DSR
GND 7	7 GND
DTR 8	8 DCD
	20 DTR

POS 30+ / 60+ Scale

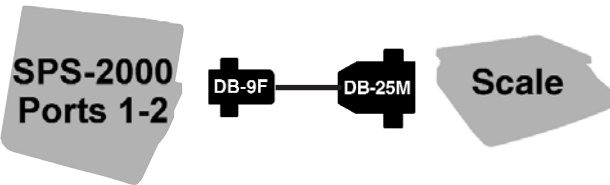

CRS Part No. 522070 – 5 Feet

ECR DB-9F	Scale DB-25M
DCD 1	0-1 ChGND
RXD 2	2 TXD
TXD 3	3 RXD
DTR 4	4 RTS
GND 5	5 CTS
DSR 6	6 DSR
RTS 7	7 GND
CTS 8	8 DCD
VCC 9	20 DTR

POS 30+ / 60+ Scale

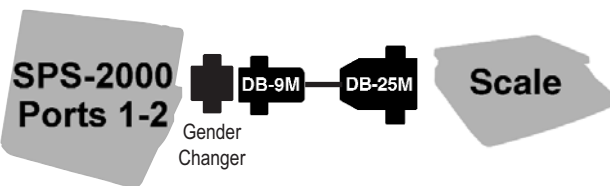

CRS Part No. 522033 – 5 Feet

ECR DB-9M	Scale DB-25M
DCD 1	0-1 ChGND
RXD 2	2 TXD
TXD 3	3 RXD
DTR 4	4 RTS
GND 5	5 CTS
DSR 6	6 DSR
RTS 7	7 GND
CTS 8	8 DCD
VCC 9	20 DTR

SPS-2000 Cable Configurations

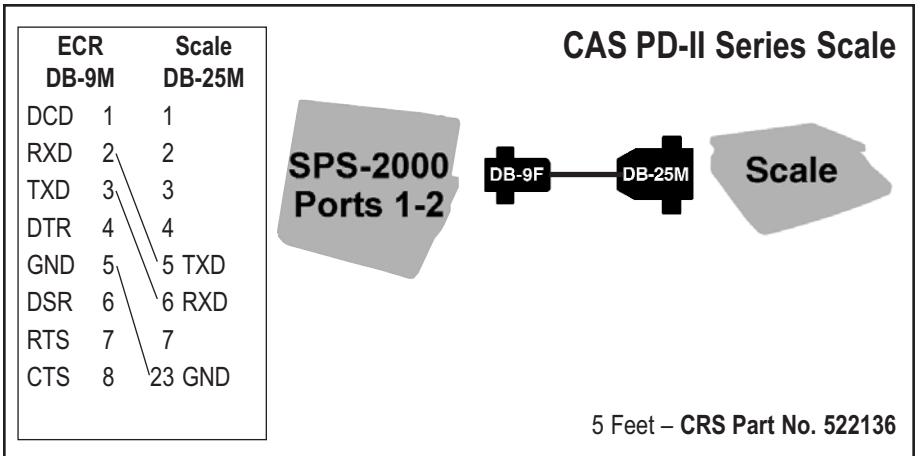
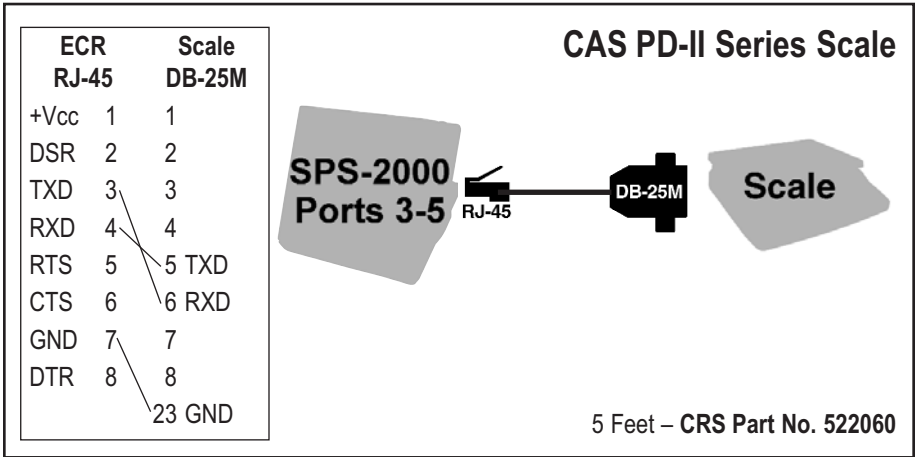

SPS-2000 Cable Configurations

CAS SW Series Scale

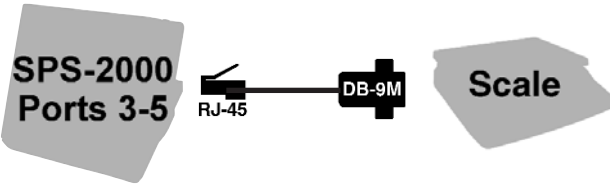

	ECR RJ-45	Scale DB-9M
DCD	1	1
DSR	2	2 TXD
TXD	3	3 RXD
RXD	4	4
RTS	5	5
CTS	6	6
GND	7	7 GND
DTR	8	8

CRS Part No. 522139 – 5 Feet

CAS SW Series Scale

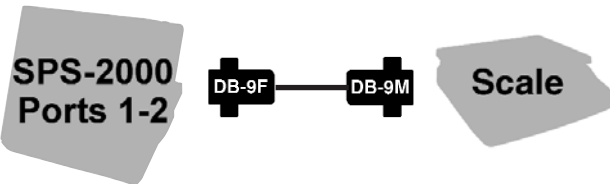

	ECR DB-9F	Scale DB-9M
DCD	1	1
RXD	2	2 TXD
TXD	3	3 RXD
DTR	4	4
GND	5	5
DSR	6	6
RTS	7	7 GND
CTS	8	8
VCC	9	9

CRS Part No. 522141 – 5 Feet

CAS SW Series Scale

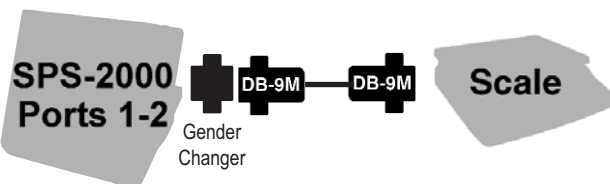

	ECR DB-9M	Scale DB-9M
DCD	1	1
RXD	2	2 TXD
TXD	3	3 RXD
DTR	4	4
GND	5	5
DSR	6	6
RTS	7	7 GND
CTS	8	8
VCC	9	9

CRS Part No. 522138 – 5 Feet

SPS-2000 Cable Configurations

NCI 6710/6720 Scale

ECR RJ-45	Scale DB-9M
DCD 1	1
DSR 2	2 TXD
TXD 3	3 RXD
RXD 4	4
RTS 5	5 GND
CTS 6	6
GND 7	7
DTR 8	8

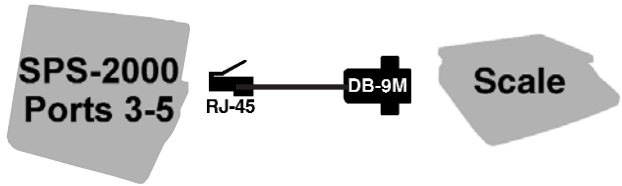

5 Feet – CRS Part No. 522057

NCI 6710/6720 Scale

ECR RJ-45	Scale DB-15M
DCD 1	1 RXD
DSR 2	2 TXD
TXD 3	3 GND
RXD 4	4
RTS 5	5
CTS 6	6
GND 7	7
DTR 8	8

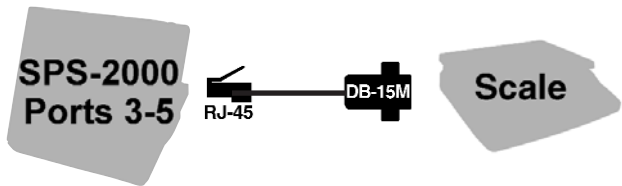

5 Feet – CRS Part No. 522044

NCI 6710/6720 Scale

ECR DB-9M	Scale DB-9M
DCD 1	1
RXD 2	2 TXD
TXD 3	3 RXD
DTR 4	4
GND 5	5 GND
DSR 6	6
RTS 7	7
CTS 8	8
ShieldFR-0	

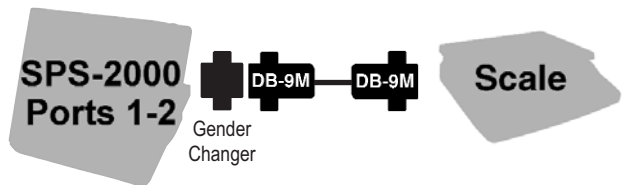

5 Feet – CRS Part No. 522056

SPS-2000 Cable Configurations

NCI 6710/6720 Scale

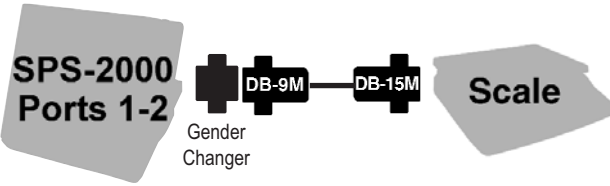

CRS Part No. 522043 – 5 Feet

ECR	Scale
DB-9M	DB-15M
DCD 1	1 RXD
RXD 2	2 TXD
TXD 3	3 GND
DTR 4	4
GND 5	5
DSR 6	6
RTS 7	7
CTS 8	8
ShieldFR	0

NCI 4100 Scale

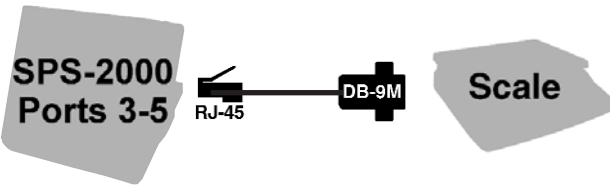

N/A

ECR	Scale
RJ-45	DB-9M
+Vcc 1	1 GND
DSR 2	2
TXD 3	3 TXD
RXD 4	4
RTS 5	5
CTS 6	6
GND 7	7
DTR 8	8
	9 RXD

NCI 4100 Scale

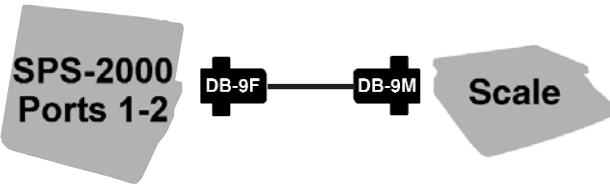

N/A

ECR	Scale
DB-9M	DB-9M
DCD 1	1 GND
RXD 2	2
TXD 3	3 TXD
DTR 4	4
GND 5	5
DSR 6	6
RTS 7	7
CTS 8	8
	9 RXD

SPS-2000 Cable Configurations

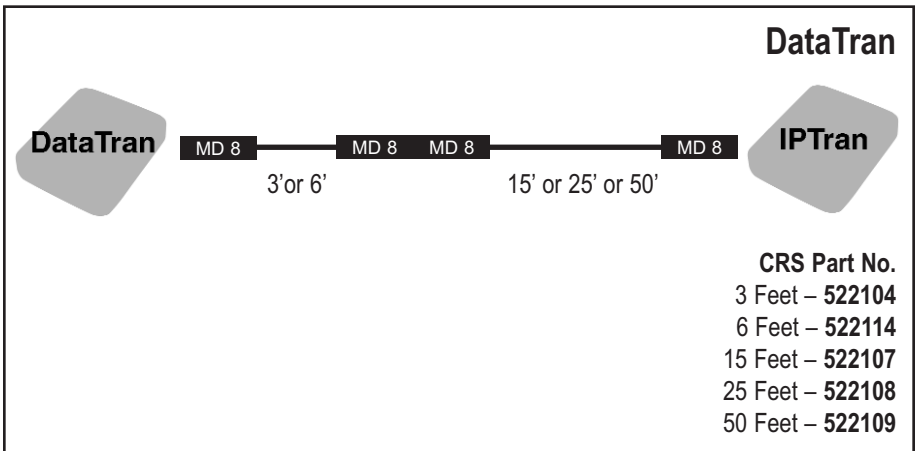
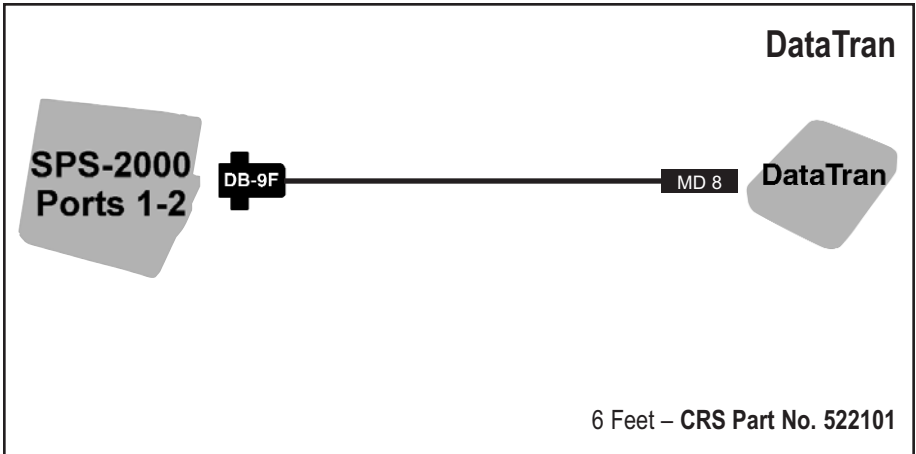
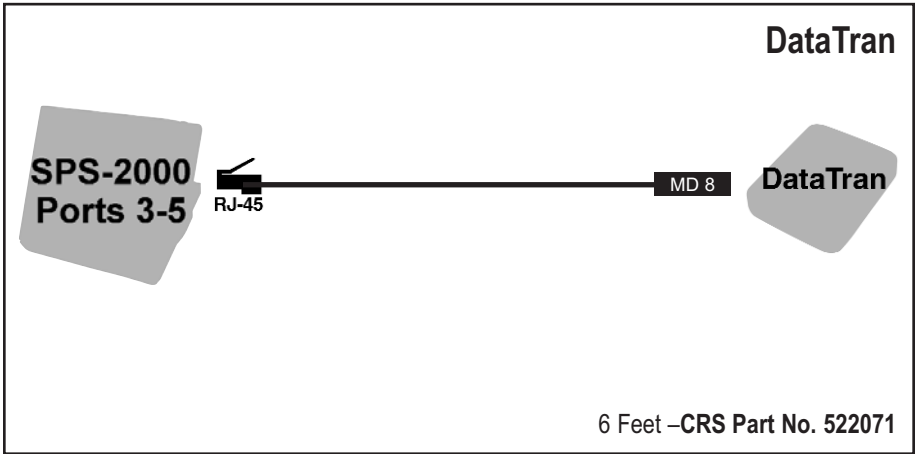

SPS-2000 Cable Configurations

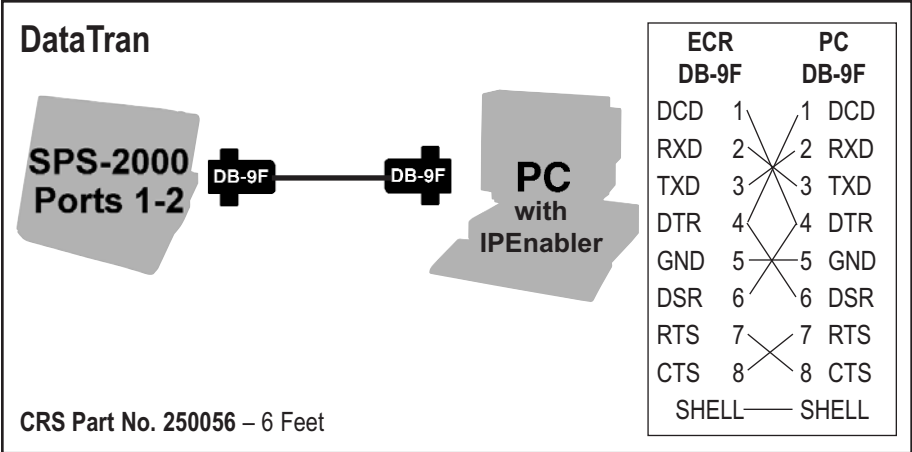
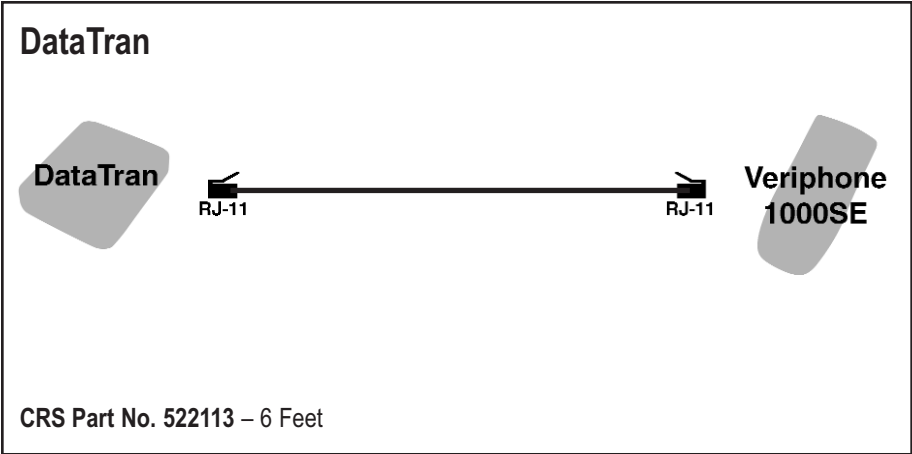

SPS-2000 Cable Configurations

ECR RJ-45	Video DB-9F
DCD 1	1 DCD
DSR 2	2 RXD
TXD 3	3 TXD
RXD 4	4 DTR
RTS 5	5 GND
CTS 6	6 DSR
GND 7	7 RTS
DTR 8	8 CTS
	9 RI

Video

5 Feet – CRS Part No. 522032

ECR RJ-45	Video DB-25F
DCD 1	1 ChGND
DSR 2	2 TXD
TXD 3	3 RXD
RXD 4	4 RTS
RTS 5	5 CTS
CTS 6	6 DSR
GND 7	7 GND
DTR 8	8 DCD
	20 DTR

Video

5 Feet– CRS Part No. 522036

SPS-2000 Cable Configurations

Video

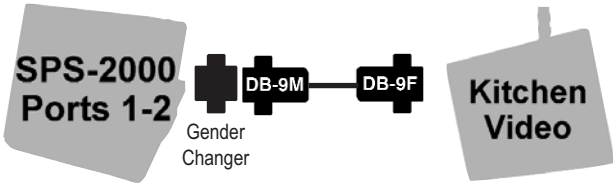

CRS Part No. 522126 – 5 Feet

	ECR DB-9M		PC DB-9F
DCD	1	1	DCD
RXD	2	2	RXD
TXD	3	3	TXD
DTR	4	4	DTR
GND	5	5	GND
DSR	6	6	DSR
RTS	7	7	RTS
CTS	8	8	CTS
VCC	9	9	VCC

Video

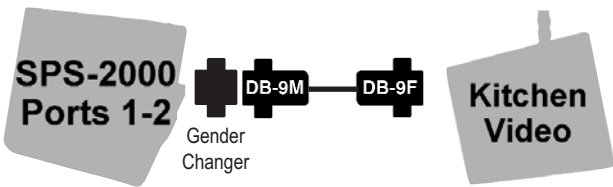

CRS Part No. 522038 – 5 Feet

	ECR DB-9M		Video DB-25F
DCD	1	0-1	ChGND
RXD	2	2	TXD
TXD	3	3	RXD
DTR	4	4	RTS
GND	5	5	CTS
DSR	6	6	DSR
RTS	7	7	GND
CTS	8	8	DCD
VCC	9	20	DTR

SPS-2000 Cable Configurations

PC	Monitor
HDB-15	HDB-15
BLUE 1—1	BLUE
GREEN 2—2	GREEN
RED 3—3	RED
GND 5—5	GND
GND 6—6	GND
GND 7—7	GND
GND 8—8	GND
GND 10—10	GND
HSYNC 13—13	HSYNC
VSYNC 14—14	VSYNC

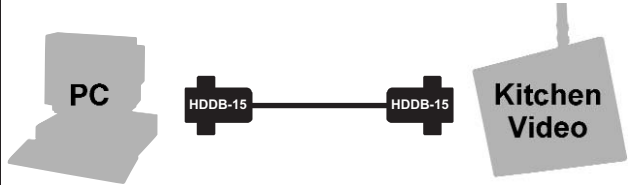

VGA Cables

SPS-2000

VGA Cables— Molded:

- 10 Feet (14C) – CRS Part No. 250009
- 25 Feet (15C) – CRS Part No. 250010

VGA Extension Cables:

- 25 Feet – CRS Part No. 522042
- 50 Feet – CRS Part No. 522040

SuperVGA Cables:

- 6 Feet (M/F) – CRS Part No. 250053
- 6 Feet (M/M) – CRS Part No. 250054
- 10 Feet (M/M) – CRS Part No. 250055

SPS-2000 Cable Configurations

Multi-Video VGA Cable for MicroPlus Video Controller

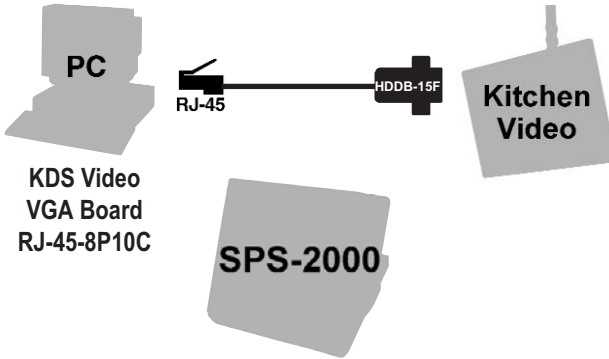

VGA Board RJ-45	Monitor HDDB-15F
GND 1	1 BLUE
GND 2	2 GREEN
VSYNC 3	3 RED
BLUE 4	4 GND
HSYNC 5	5 GND
GREEN 6	6 GND
NotUsed 7	7 GND
RED 8	8 GND
SHIELD 9	10 GND
GND 10	13 HSYNC
	14 VSYNC

Jumper Pins 5-6-7-8-10

CRS Part No. 522050 – 25 Feet
 CRS Part No. 522051 – 50 Feet

Bump Bar - MicroPlus Video

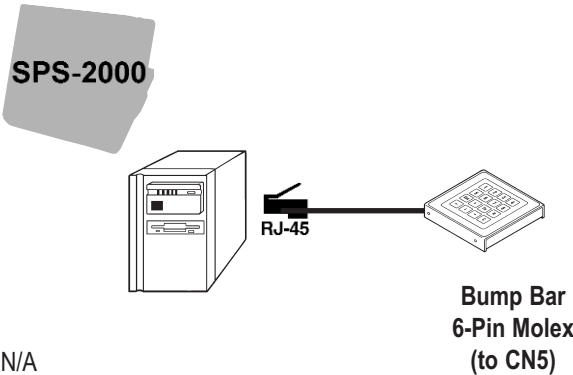

KVS PC RJ-45	BumpBar
SIG GND 1	1 FRM GND
485 BUSB 2	2 + V
485 BUSA 3	3 485 BUSA
FRM GRD 4	4 485 BUSB
+ V 5	5 SIG GRD
Not Used 6	6 Not Used
+ V 7	
SIG GND 8	

N/A

SPS-2000 Cable Configurations

Ethernet Patch



Cross Over Cable

<u>Part No</u>	
2500711 Foot
2500425 Feet
25004310 Feet
25004415 Feet
25004525 Feet
25004650 Feet
250047100 Feet

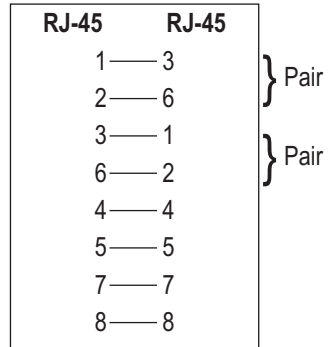

Straight Through Cable

<u>Part No</u>	
2500701 Foot
2500365 Feet
25003710 Feet
25003815 Feet
25003925 Feet
25004050 Feet
250041100 Feet

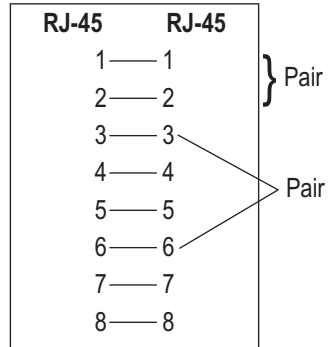

SPS-2000 Cable Configurations

Berg Liquor

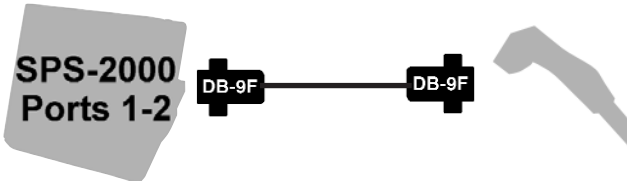

ECR DB-9F		Berg Liq DB-9F
1		1
RXD	2	2 RXD
TXD	3	3 TXD
DTR	4	4 DTR
GND	5	5 GND
DSR	6	6 DSR
RTS	7	7 CTS
CTS	8	8 RTS

N/A

DB-9 to RJ-45 Adapter

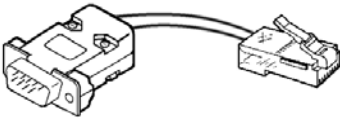

	DB-9M		RJ-45
DCD	1	1	DCD
RXD	2	2	DSR
TXD	3	3	TXD
DTR	4	4	RXD
GND	5	5	RTS
DSR	6	6	CTS
RTS	7	7	GND
CTS	8	8	DTR
VCC	9		

CRS Part No. 522119