



Multimedia MRP01 Display Installation Guide

The MRP01 allows the customer to display elevator information and multimedia content. The MRP01 is capable of being mounted anywhere in the elevator car, with the capability of mounting the processor up to 6.5 feet away (recommended mounting on top of car) from the display with the use of the extended 6.5 foot LVDS capable.



Items Required for Installation

- + MRP Display
- + MRP Processor
- + Drilling Template
- + Hand tools (not provided)
- + Power drill (not provided)
- + LVDS cable

Related Accessories

- + Navigation Box
- + Magnet Activator (used to access/control on board programming)
- + Speaker

Summary Installation Instructions

Mounting Instructions

1. Before installation please ensure there is enough space on the back of the COP/installation area to allow for ventilation for LCD unit.

If replacing the existing display:

- + Remove display that is being replaced and make sure the area is clean and free of dust and dirt.
- + Remove all of the weld stud mounts used for the previous display from the COP.

2. Remove adhesive backing from the template and be careful when applying to COP/Installation area. It is important to ensure that it is placed level and with correct placement for cable clearance.
3. Place drill template over desired area for display placement.
4. Drill four mounting holes at 0.177" as identified on the template
(when there is no existing hole for the cable, use the template to cut out hole large enough for the LVDS cable to pass through).
5. Remove display from the packaging provided. Observe anti-static handling procedures.
6. Remove the processor from the back of the display, take care when disconnecting the cable.
7. Remove all nuts and washers provided. Leave the studs fixed to the display frame.
8. From the front of the panel insert the display fixing studs through the drilled holes and fasten in place.

Mounting Instructions (Driver Board)

1. Remove driver board from packaging. Observe anti-static procedures and handle carefully.
2. Peel off protective tape cable.
3. Remove LVDS cable from display.
4. Feed LVDS cable through hole created using drilling template.
5. Mount Processor in desired location.
6. Connect LVDS cable to display.
7. Mount gong/hall lantern if desired.
8. Insert power.

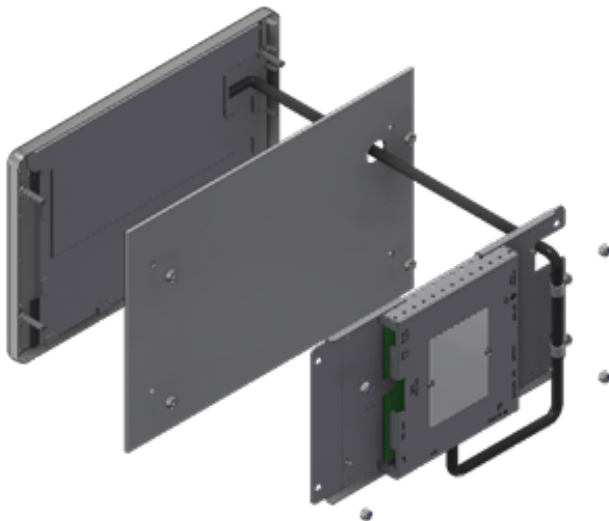

Short cable mounting – Display and processor mounted either side of fixture



6.5' cable mounting – Display is mounted on fixture and processor is mounted top of car

Step 1

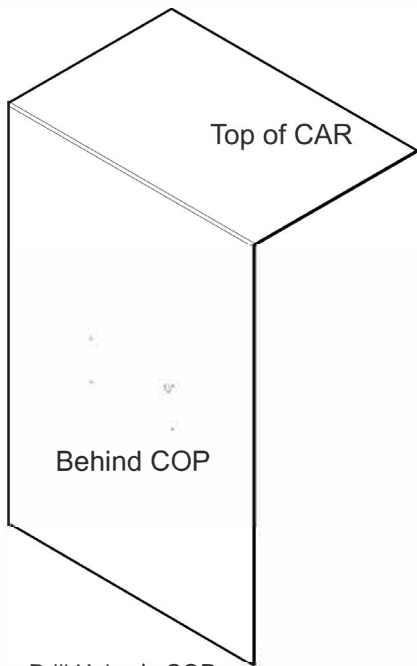

Drill Holes in COP

Step 2

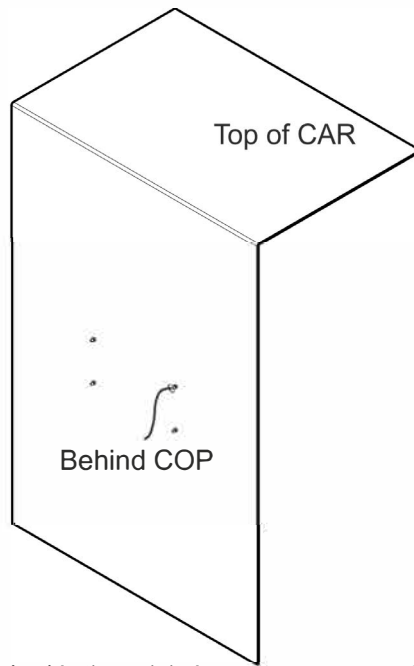

Feed cable through hole
Assemble Display to COP

Step 3

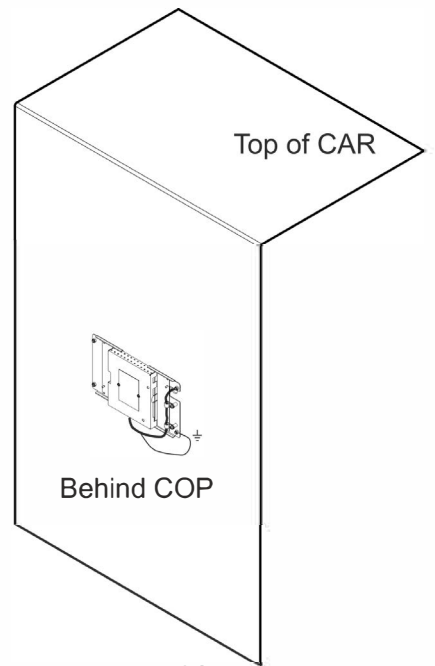

Secure Processor to COP
Connect Display cable to Processor

COP - Landscape

Step 1

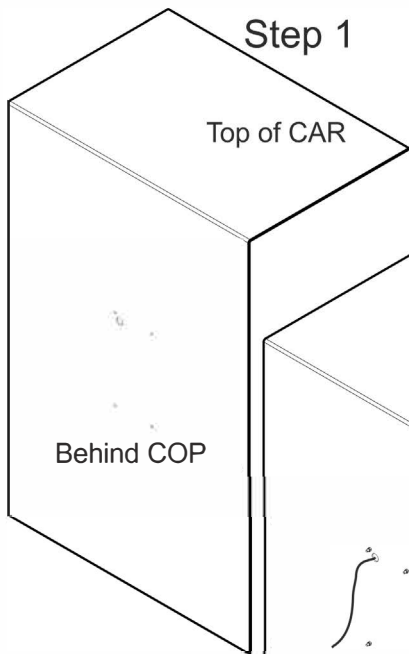

Drill Holes in COP

Step 2

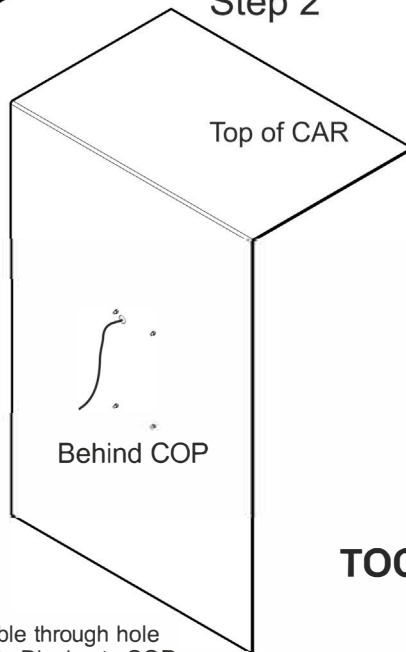

Feed cable through hole
Assemble Display to COP

Step 3

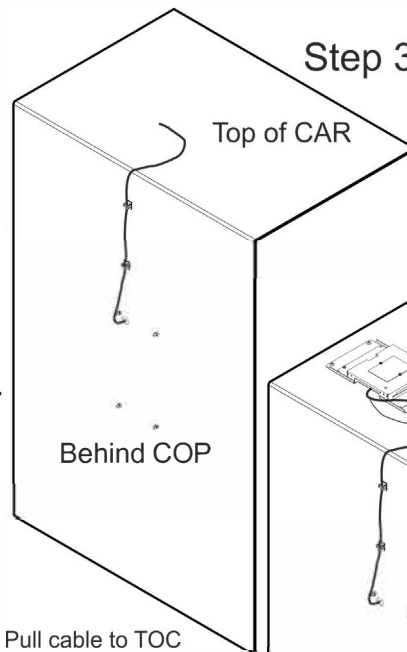

Pull cable to TOC

Step 4

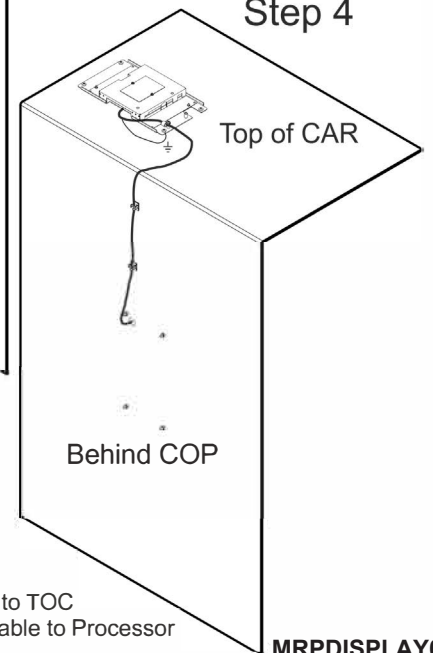

Secure Processor to TOC
Connect Display cable to Processor

TOC - Portrait

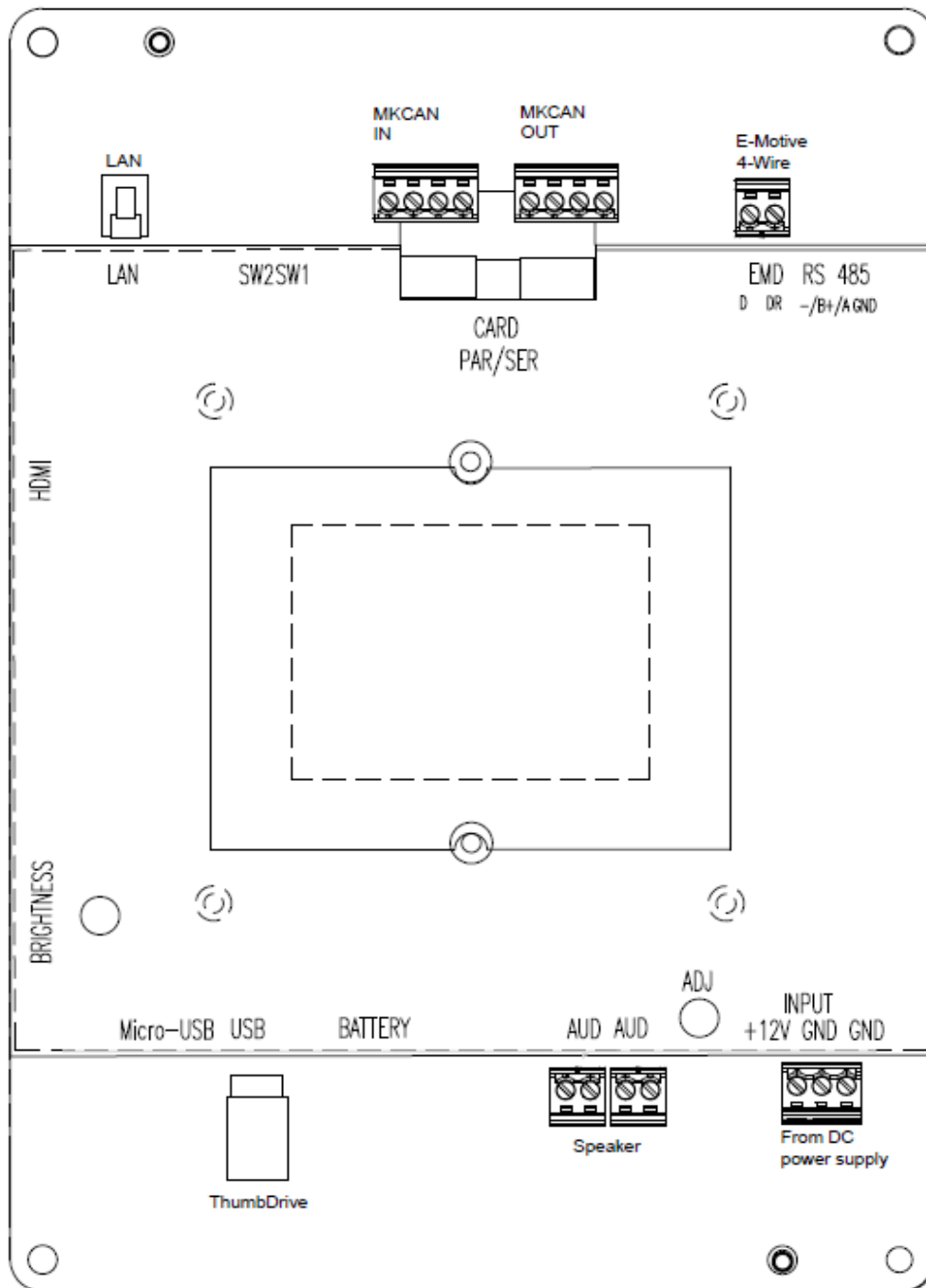

Notes

- a) *Brightness* – This allows user to adjust the display brightness. By default, this is set to 50% brightness.
- b) *ADJ* – This allows user to adjust the volume for the speaker output. By default, this is set to 50%.



Caution:

- + Risk of electric shock. Never remove the casing of the unit.
- + Please take all necessary anti-static precautions before handling equipment.
- + Ensure that the Power Supply is connected properly and that the voltage is correct before turning on the system.
- + Handle LCD unit with care. Do not knock and place heavy object on top surface of the LCD unit.