

CR-2000

KEYPAD / CARD READER



4564 Johnston Parkway, Cleveland, Ohio 44128

P. 800 426 9912 F. 216 518 9884

Sales Inquiries: salesupport@emxinc.com

Technical Support: technical@emxinc.com

www.emxinc.com

Contents

Product Overview	2
Indicators and Controls	2
Specifications	3
Connections	3
Installation	5
Programming	6
Ordering Information	10
Warranty	10

Product Overview

The CR-2000 is an inductive contact-less card reader in a metal water proof housing that also acts as a keypad control. The CR-2000 provides safe secure access control for any combination of 2000 users by the use of the Mifare pass card or individual user pass codes.

The CR-2000 has low power consumption (30mA standby) luminous keypad for nighttime use, Short circuit protection, tamper alarm output, and the Wiegand output for monitoring of user access.

The CR-2000 may also be used stand alone for access control of doors, gate and barrier arms.

Features

- Low 30 mA standby current
- Luminous keypad: for nighttime operation
- 2000 user support
- Independent password support (may use code or card for access)
- Keypad user delete (for lost or stolen cards or codes)
- Output short circuit protection
- Wiegand output: Wg26 for cards
- Tamper alarm output
- Doorbell button: Independent from circuit works with any doorbell
- User pass card code change (allows user to use code they can remember in case card is lost or forgotten)

Indicators and Controls

Operation State	Red LED	Green LED	Beeper	Notes
Standby	Slow Blink	Off		
Key Activation			Beep	
Success	Off	On	Long Beep	
Fail			3 Short Beeps	
Enter Programming	On	Off	Long Beep	Indicator is Orange
Set Condition	On	On		
Exit Programming	Slow Blink	Off	Long Beep	
Unlock	Off	On	Long Beep	
Alarm	Fast Blink	Off	Alarm Sound	

Specifications

Specifications	
Power Supply	9-25VDC
Power Supply Tolerance	+/- 20% of Power Rating
Current Draw Standby	</= 30mA
Read Range	1.1 in (3cm) – 3.1in (8cm)
Capacity (users)	2000 Car and or Pass Codes
Temperature Range	-13°F (-25°C) to 140°F (60°C)
Operating Humidity	10% ~ 90%
Electric Lock Output	</= 3A
Alarm Output	</= 20A
Short Circuit Protection Time	</= 100uS
Activation Time	0-99 Seconds (Adjustable)
Size	4.74in (120mm) x 2.2in(56mm) x 0.71in(18mm)
Certifications	CE

Connections

No.	Designation	Color	Function
1	Bell-A	Pink	Door Bell Terminal A
2	Bell-B	Pale Blue	Door Bell Terminal B
3	D0	Green	WG Output Line (D0)
4	D1	White	WG Output Line (D1)
5	Alarm	Grey	Alarm Negative (Alarm positive connected to +12V)
6	Open	Yellow	Exit Button (Other end of exit button connected to GND)
7	D-IN	Brown	Magnet Switch(Other end of magnet SW connected to GND)
8	AC/DC+	RED	Power 9-25V DC + Input
9	AC/DC-	Black	Power 9-25V DC - Input
10	N/O	Blue	Relay Internal Contact (Normally Open)
11	COM	Purple	Relay Internal Contact (Common)
12	N/C	Orange	Relay Internal Contact (Normally Closed)
13	GND	Shield	Ground (Earth Ground)

Connections (Continued)

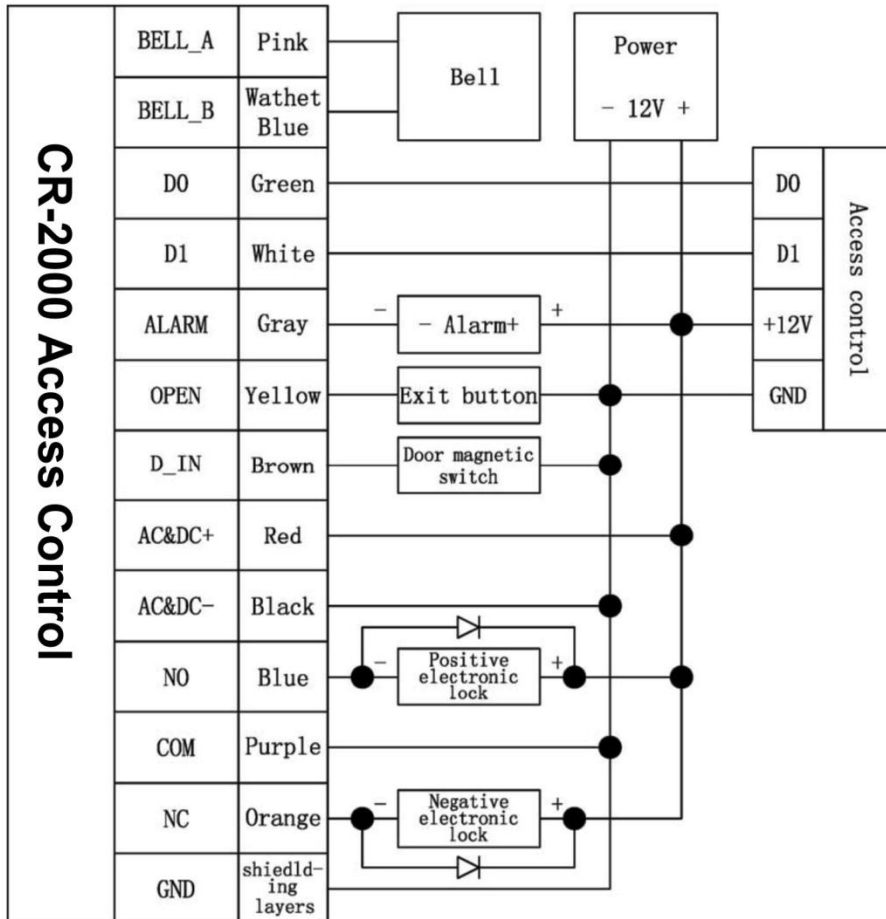
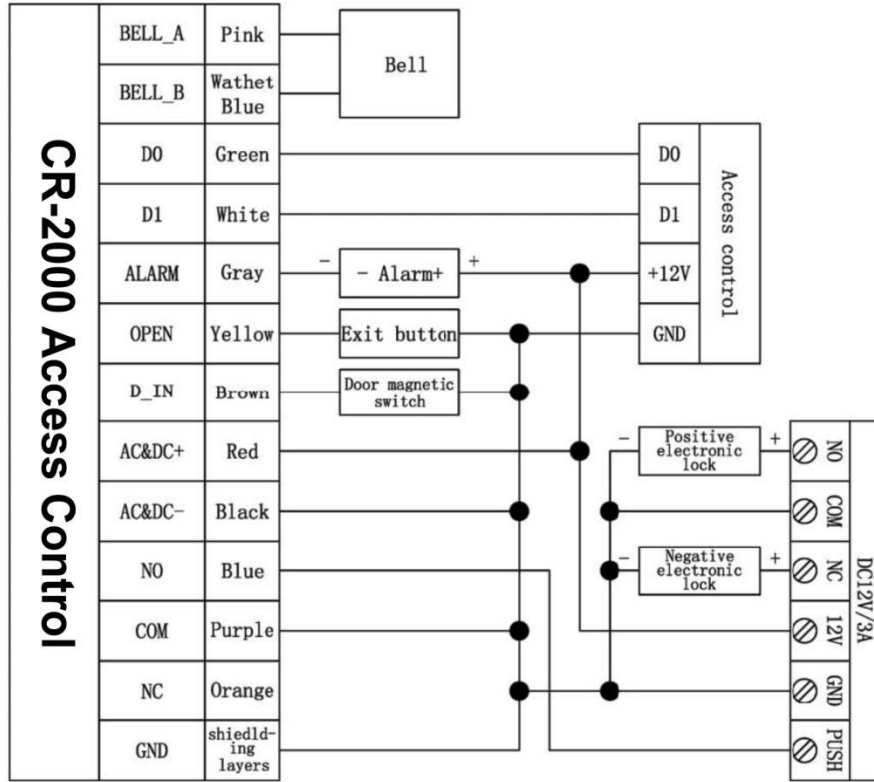

Installation

Find location on mounting surface that has an opening of at least 5 x 2.2 inches.

1. Remove mounting plate from the back of the unit to use as a template for the mounting screws. (Figure 1.0)
2. Drill mounting holes and affix mounting plate to the surface. Also fits to ordinary wall outlet junction boxes.
3. Make sure wires are routed so they are not damaged or shorted
4. Make connections per site requirements see schematics (Figure 2.0, 2.1, 2.2)
5. Install front cover to back cover and tighten unit in place.
6. Proceed to programming

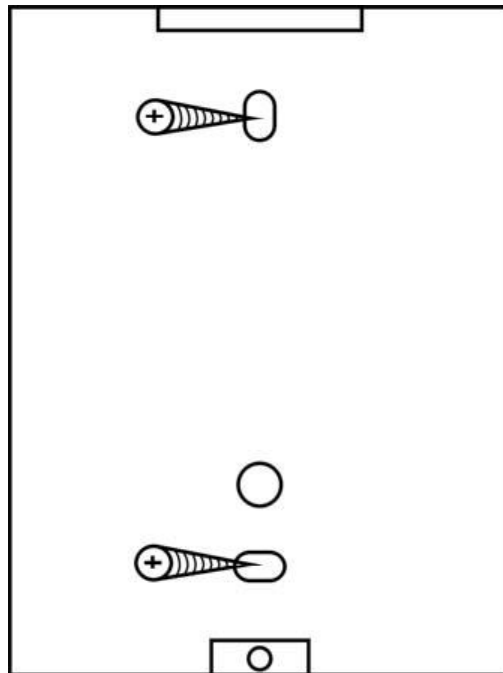

Programming

To enter programming mode press (system default)

1. To change Administrator pass code press , repeat . Note administrator pass code is 6 ~ 8 random numbers. Please remember to record this new pass code for future reference.

2. Add Users

2.1 Adding cards automatic increase. Press , ,
... Press to end adding cards and to exit program mode.

2.2 Adding designated card(s) manually. Press ,
, Press to end adding card(s).

2.3 Adding cards to designated ID locations scan cards.

Press , , ...

2.4 Adding cards to designated ID locations manually.

Press ,
 , ...

Note: Input ID number is 1 ~ 4 digits Example (1), (01), (001), (0001) with the range being 1 ~ 2000.

2.5 Adding ID number and Password number manually.

Press , , ...

This is for users with pass code only no cards. Code may be any four digit combination except for (1234, this is reserved by the system).

Note: The key represents the pound symbol key in all instruction sequences.

You are still in program mode indicated by the solid RED light. You may exit the program mode by pressing the key or wait until the unit has timed out, indicated by flashing RED light.

Programming (Continued)

3. Deleting Users

3.1 Delete card(s) by swiping. Press , , ...

3.2 Delete designated card.

Press , , ...

3.3 Delete Designated ID number.

Press , , ...

3.4 Delete all: Press ,

4. Door Opening Setting

4.1 Card Open: Press , .

4.2 Card Plus Password Open: Press , .

4.3 Card or Password Open (Factory default): Press , .

5. Unlock Time Setting

5.1 Press , , Range 0 to 99 seconds, (factory default is 5 seconds).

6. Alarm Output Time Setting

6.1 Press , , Range is 0 to 3 minutes, (factory default is 1 minute).

7. Door Ajar Alarm Function

7.1 Press , Ignore (factory default)

7.2 Press , Send alarm signal

A. If door is ajar after 1 minute the alarm will trip sounding the built in buzzer for 1 minute and then turn off.

B. If door is forced open the built in alarm and the external alarm will trigger.

Programming (Continued)

8. Security Mode

8.1 Press , Normal (factory default) See section 10.2

8.2 Press , Invalid Lock (Within 10 minutes multiple swipes of invalid card or input of invalid pass code 10 times will deactivate the keypad for 10 minutes)

9. User password modify

9.1 With Pass Card: Press , ,
 , If this is first time use on a new card the default password is (1234).

9.2 With Pass Code Only: Press ,
 ,
For users without pass cards.

10. Door Open Operation

10.1 Card Open

10.2 Password open. Press If correct door will open. If incorrect code is entered you have 9 more attempts before unit locks and needs reset by administrator or swipe of valid card.

10.3 Card plus Password Open: If card is valid and user password is correct the door will open. If card or password is incorrect you will have 9 more attempts before unit locks and needs reset by administrator or valid card swipe and correct password entry.

11. Administrator Functions

11.1 Remove Alarms See section 1 page 3

11.2 Administering users, passwords, alarm settings, timing functions

Programming (Continued)

Restore Factory setting

12. Restore factory settings

- 12.1 Disconnect power
 - 12.2 Press the # button
 - 12.3 Restore power while holding the # button for 4 seconds
 - 12.4 The CR-2000 will beep twice
 - 12.5 Release the # button
 - 12.6 Reset should be complete
- Note: Restoring to factory setting will not delete user(s) data.

13. Status indicator

3.1 Press to turn off RED indicator flash in light bar

3.2 Press to turn on RED indicator flash in light bar

Ordering Information

CR-2000
CARX-20

Card Reader / Keypad
1.8mm Mifare

Warranty

EMX Industries Incorporated warrants all products to be free of defects in materials and workmanship for a period of two years under normal use and service from the date of sale to our customer. This warranty does not cover normal wear and tear, abuse, misuse, overloading, altered products, damage caused by incorrect connections, lightning damage, or use other than intended design.

There is no warranty of merchantability. There are no warranties expressed or implied or any affirmation of fact or representation except as set forth herein.

EMX Industries Inc. sole responsibility and liability, and the purchaser's exclusive remedy shall be limited to the repair or replacement at EMX Industries option of a part or parts found not conforming to the warranty. In no event shall EMX Industries Inc. be liable for damages, including but not limited to damages resulting from non-conformity, defect in material or workmanship.

Effective date: January 1st, 2002



BLANK PAGE



4564 Johnston Parkway
Cleveland, Ohio 44128
United States of America
www.emxinc.com

Technical Support: (216) 834-0761
technical@emxinc.com

Sales: (216) 518-9888
Fax: (216) 518-9884
salesupport@emxinc.com

