

25 Code GTO Digital Keypad

Instructions for Wired and Wireless Installations



Thank you for purchasing the GTO Digital Keypad. Be sure to read the directions carefully and completely. Before permanently mounting the keypad, please program the keypad and test its range.

IMPORTANT: Your keypad may need to be hard wired due to the fact that it must accept interference according to FCC regulations listed below. For example, applications that are relatively close to cell towers or airports may receive intermittent interference and require hard-wiring.

The GTO Digital Keypad is a multipurpose keypad that can work with other applications in addition to GTO gate openers and locks. As a wired keypad it can operate garage door openers and gate openers, that require 24 volts or less and accept normally open contacts.

As a wireless keypad, the keypad must be used in conjunction with the GTO garage door receiver kit (part # RB709U-NB) on any other garage door.

SAFETY NOTE: Never install the keypad where a person can reach through the gate to activate it, or where a person can touch the gate while activating the keypad. The recommended minimum distance between the gate and keypad is 10 ft.

FCC WARNING: Changes or modifications to this unit not expressly approved by the party responsible for compliance could void the user's authority to operate the equipment.

NOTE: This equipment has been tested and found to comply with the limits for a Class B digital device, pursuant to Part 15 of the FCC Rules. These limits are designed to provide reasonable protection against harmful interference in a residential installation. This equipment generates, uses and can radiate radio frequency energy and, if not installed and used in accordance with the instructions, may cause harmful interference to radio communications.

However, there is no guarantee that interference will not occur in particular installations. If this equipment does cause harmful interference to radio or television reception, which can be determined by turning the equipment off and on, the user is encouraged to try to correct the interference by one or more of the following measures: • Reorient or replace the receiver antenna. • Increase the separation between the equipment and the receiver. • Connect the equipment into an outlet on a circuit different from that to which the receiver is connected. • Consult the dealer or an experienced radio/TV technician for help.

Keypad Features

Keypad

- The keypad illuminates and beeps at the press of any key.
- When a valid code is entered, the STATUS light will blink rapidly and the keypad will beep three times.
- The keypad remains active for 40 seconds after entering a valid code: pressing any key on the keypad while the gate is in motion will stop the gate; pressing any key while the gate is stopped will cause the gate to reverse direction. After 40 seconds, the keypad will beep 3 three times and go into "idle" mode.
- If more than 20 key presses are entered without matching an Entry Code, the STATUS light will flash rapidly, an error tone will sound for 1 second, and the keypad will go into "lock-down" mode for 40 seconds.
- If more than 10 seconds elapse between key presses, the keypad will beep 3 three times and go into "idle" mode.

Master and Entry Codes

- Up to 25 Entry Codes may be programmed into the keypad.
- Temporary Entry Codes can be programmed to expire within one to seven (1-7) days.
- Entry Codes remain stored in memory even when the keypad batteries go dead.
- All Entry Codes are deleted by pressing the RESET button on the keypad; Master Code defaults to "1234."

Limited One Year Warranty

Gates That Open, LLC, "GTO" gate opener accessories are warranted by the manufacturer against defects in workmanship for a period of one (1) year from the date of purchase, provided recommended installation procedures have been followed.

In the case of product failure due to defective material or manufacturer workmanship within the one (1) year warranty period, the accessory will be repaired or replaced (at the manufacturer's option) at no charge to the customer, if returned freight prepaid to GTO 3121 Hartsfield Rd., Tallahassee, FL 32303. **IMPORTANT:** Call 850/575-4144 or fax 850/575-8950 for a Return Goods Authorization (RGA) number before returning goods to factory. Products received at the factory without an RGA will not be accepted. Replacement or repaired parts are covered by this warranty for the remainder of the one (1) year warranty period or six (6) months, whichever is greater. GTO will pay the shipping charges for return to the owner of items repaired.

The manufacturer will not be responsible for any charges or damages incurred in the removal of the defective parts for repair, or for the reinstallation of those parts after repair. This warranty shall be considered void if damage to the product(s) was due to improper installation or use, connection to an improper power source, tampering, or if damage was caused by electrical power surge or lightning, wind, fire, flood, insects, or other natural agent.

After the one (1) year warranty period, GTO or one of its authorized service centers will make any necessary repairs for a nominal fee. Call GTO at 850/575-4144 for more information. This warranty gives you specific legal rights, and you may also have other rights which may vary from state to state. This warranty is in lieu of all other warranties, expressed or implied. **NOTE:** Verification of the warranty period requires copies of receipts or other proof of purchase. Please retain those records.

Keypad Description

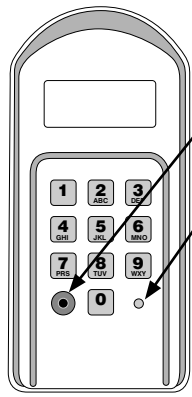

Keypad - Front

PROGRAM button:
Used to program access codes.

STATUS Light:
This led will blink once when any key is pressed and provides visual feedback during access code programming.

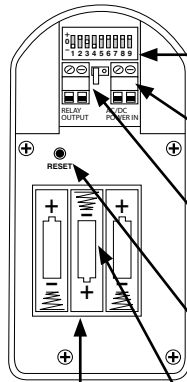

Keypad - Inside

DIP Switches:
Match these switches to your remote transmitter to program the keypad.

Power Input:
Used to connect power supply (8-24 Vac/dc) when using outside power source.

Relay output:
Used to connect Keypad to gate opener in hard-wired applications.

RESET button:
Pressing this button for 2 seconds will reprogram key pad to factory settings. All codes are deleted. Default master code is 1234.

Battery Holder:
Use 3 AA batteries if hard-wired power supply is not used. If external power source is used the 3 AA batteries will provide a back-up power source.

Installing Batteries

NOTE: 3 AA batteries are required to power the keypad unless an external power supply such as the gate opener's power source is used. Low voltage wire from the external power source must be connected to the POWER IN terminals on the keypad control board, if batteries are not installed.

Step 1: Remove the two screws from the bottom of the keypad and separate the keypad from its housing.

Step 2: Install 3 AA batteries (not included).

Wireless Installation of the Keypad

NOTE: For wireless applications, the distance from the keypad to the opener's receiver should not exceed 50 ft. Always test the keypad range before permanently mounting it.

Step 1: Mount the keypad cover using the screws provided. Set the keypad DIP switches to match your entry transmitter's DIP switch settings.

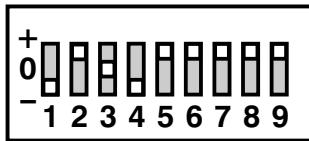

NOTE: If you have not changed your opener's transmitter code from the factory setting, see the "Setting Your Personal Transmitter Code" section in the gate opener's manual then set the keypad DIP switches to match the new transmitter DIP switch setting.

Step 2: Slide the keypad into the cover and secure with the small screws provided.

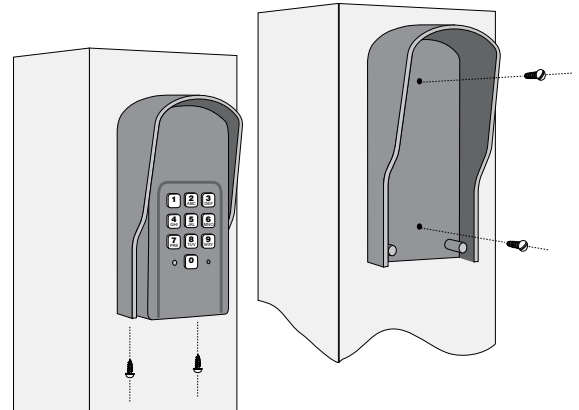

Wired Installation of the Keypad

NOTE: If you also plan to power the keypad with the gate opener's power source, run two pairs of wires as described below. One pair to hard-wire the keypad and the other pair to connect the keypad to the gate opener's battery.

Step 1: Turn the gate opener's power switch **OFF**. Use 16 gauge, stranded, direct burial low voltage wire (part no. RB509) to connect the keypad to the opener control board. Run wire through PVC pipe from the ground to keypad and from the ground to the opener control board to protect the wire from lawn mowers or grazing animals.

Determine how the wire will enter the keypad (i.e. from the back through a hole drilled in the mounting post or running the wire on the surface of the post). Remove the small rectangular knock-out on the back of the keypad cover and pull the wire into the cover. Then mount the cover to the post using the screws provided.

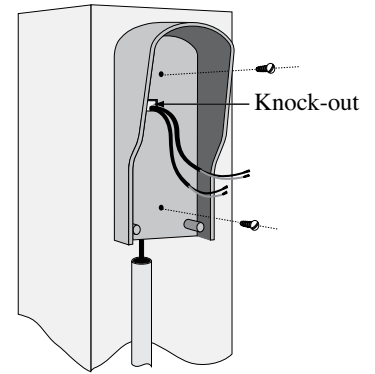

Step 2: Wire the keypad to the gate opener control board. Strip 3/16" off the ends of one pair of low voltage wires. Attach the wires to the terminal block marked RELAY on the keypad control board as shown. Then connect wire #1 to the CYCLE terminal on the gate opener control board, and wire #2 to the COM terminal on the gate opener control board

To wire the power supply to the keypad attach the wires to the AC/DC POWER IN terminal on the keypad control board as shown to the right. Connect the other end to the opener's battery - one end to the POSITIVE pole and the other to the NEGATIVE pole.

NOTE: For a hard-wired application the jumper between the two terminals on the keypad control board must be connected (ON) as shown. This will disable the 318 MHz RF transmitter.

Step 3: Slide the keypad into the cover and secure with the small screws provided.

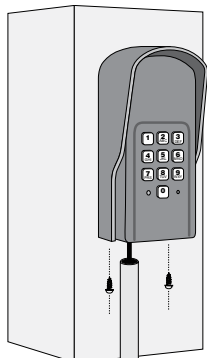

Step 4: With the power to the opener turned **OFF**. Remove opener control board cover and feed enough of the low voltage keypad wire through a strain relief to reach the gate opener control board terminals.

Step 5: Attach the wires from the keypad to the opener control board terminal blocks as shown below.

Step 6: Replace the control board cover and turn the power switch ON. Test the keypad by entering 1 2 3 4.

Step 7: Program your 'Personal Master Code' and any additional entry codes (for a total of 25 entry codes) you wish. See Programming the Keypad section.

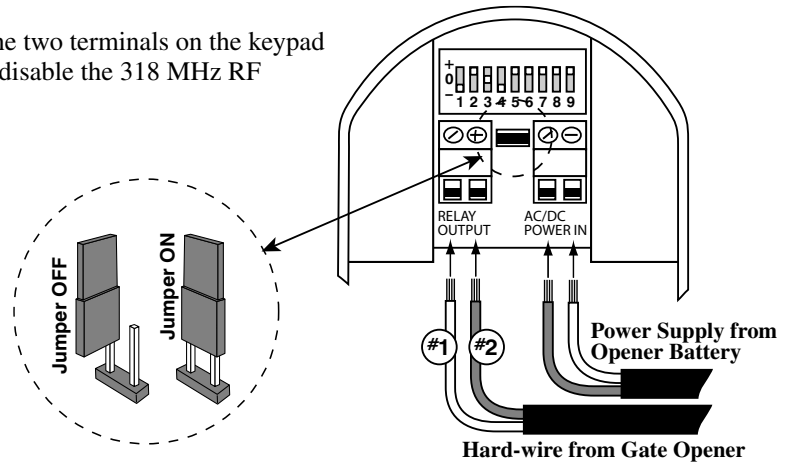

Control Board Connections

NOTE: Refer to your gate opener instruction manual for more details on wiring the gate opener control board.

Program the Keypad

- A Master Code is needed to add, remove, or program Entry Codes.
- Factory default Master Code is “1234.”
- Keypad can only enter “program” mode from “idle” mode.
- Keypad will beep three times before going into “idle” mode (more than 10 seconds between key presses).



Program Button Status Light

 **Programming Confirmed:** Keypad will beep 3 times.

 **Error Message:** Status light will flash rapidly, error tone will sound for 1 second and keypad will return to “idle” mode (changes not saved).

- Entry Code is not 4 digits.
- New Master Codes don't match (“Program New Master Code”).
- Memory is full (already 25 codes).
- No matching code is found (“Delete Entry Code”).

= Your 4-digit code.

Program New Master Code

1. Press and Release Program Button: ●
2. Enter current Master Code: (example: the factory default Master Code) **1** **2** **3** **4**
ABC DEF GHI
3. Press and Release Program Button: ●
4. Enter the Function Code: **0** **6**
MNO
5. Press and Release Program Button: ●
6. Enter the *new* Master Code:
7. Press and Release Program Button: ●
8. Enter the *new* Master Code again:
9. Press and Release Program Button: ●

Add Temporary Entry Code

*In step 4, you will need to enter a number from 1 through 7 to indicate the number of days until the Entry Code expires.

1. ●
2. Master Code
3. ●
4. **8** Function Code & # of days Code will be active*
TUV
5. ●
6. Temporary Entry Code
7. ●

Add New Entry Code

1. ●
2. Master Code
3. ●
4. **0** **2** Function Code
ABC
5. ●
6. New Entry Code
7. ●

Delete Entry Code

1. ●
2. Master Code
3. ●
4. **0** **3** Function Code
DEF
5. ●
6. Code to be deleted
7. ●

Delete All Entry Codes

1. ●
2. Master Code
3. ●
4. **0** **7** Function Code
PRS
5. ●

Normal Keypad Operation:

- If the user enters a 4-digit code that is matched to one of the 25 stored codes. The STATUS light should blink rapidly and the beeper should beep three times to confirm that a matched code is entered.
- No more than 20 key presses are allowed to obtain the 4-digit entry code.

Example:

1234 is one of the codes stored in one of the memory location.

The user can enter ‘x1234’ or ‘xxxxxxxxxxxxxxxx1234’ and the gate should be activated (x is any key). If more than 20 key presses is entered without matching one of the codes then the unit’s STATUS light should be flashing rapidly and no entry will be accepted for the next 40 seconds. The user must not enter any code for at least 40 seconds before the unit returns to normal operation; otherwise it remains in this ‘lock-down’ mode. Once the user enters a matched code, any subsequent key press within the next 40 seconds will re-activate the keypad.

Keying Indication Summary:

	Keying Error Alert Indication	Keying accepted confirmation Indication
Master Code Setting	Speaker: continuous Beep for 2 seconds STATUS light: rapid flashing	Speaker: Beep – Beep – Beep STATUS light: no light, no flashing
Permanent Entry Code	Speaker: continuous Beep for 2 seconds STATUS light: rapid flashing	Speaker: Beep – Beep – Beep STATUS light: no light, no flashing
Temporary Entry Code Setting	Speaker: continuous Beep for 2 seconds STATUS light: rapid flashing	Speaker: Beep – Beep – Beep STATUS light: no light, no flashing
Entry Code Matching	Speaker: continuous Beep for 2 seconds STATUS light: rapid flashing	Speaker: Beep – Beep – Beep (after non-matching 20 keying) STATUS light: no light, no flashing

If you have any questions or concerns, please contact our Technical Service Department at 1-800-543-1236 or 850-575-4144.
Gates That Open, LLC • 3121 Hartsfield Road • Tallahassee, Florida 32303
Telephone (850) 575-0176 • Fax (850) 575-8912 • website www.gtoaccess.com

The contents of all material available on this installation manual are copyrighted by Gates That Open, LLC (“GTO”), unless otherwise indicated. All rights are reserved by GTO, and content may not be reproduced, downloaded, disseminated, published, or transferred in any form or by any means, except with the prior, written permission of GTO. Any reprinting of GTO publications is by permission only. Copyright infringement is a violation of federal law.

GTO®, GTO/PRO®, Mighty Mule® are registered trademarks of Gates That Open, LLC. Professional Access Systems™ is a trademark of Gates That Open, LLC. and are the exclusive property of Gates That Open, LLC (“GTO”). All rights are reserved by GTO, and these marks may not be used, in any for without the prior, written permission of GTO.

