

INSTRUCTION SHEET - GENERAL INFORMATION

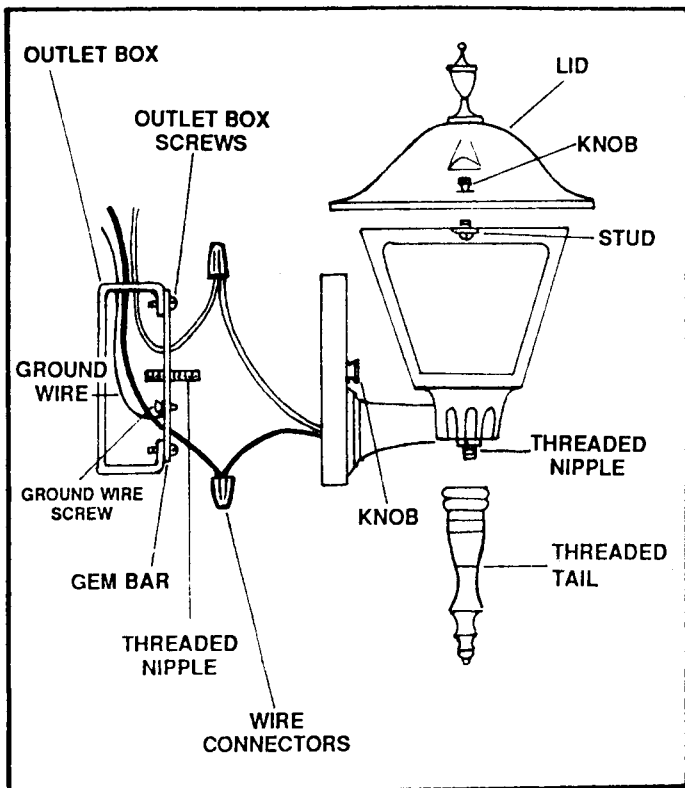

1. Read entire instruction sheet before you begin.
2. It is important to follow each step in the order given.
3. Before proceeding with any work shut off the electricity! First, turn off the wall switch. Next, shut off all power at the fuse box (see below). Leave the electricity off until you are completely finished installing the fixture.
4. Unpack the new fixture and make sure all the parts are included. If not, return to the place of purchase and secure the necessary parts.
5. If you are replacing an old fixture, observe how it was installed before removing. Chances are, installation of the new fixture will be the same.
6. If you have doubts about the correct installation of a light fixture, or if it fails to operate properly, please contact a licensed electrician. Be sure to use bulbs with wattages no greater than those specified for the fixture.
7. Care of glass: Clean when cool with soft cloth and window cleaner.

BEFORE YOU START

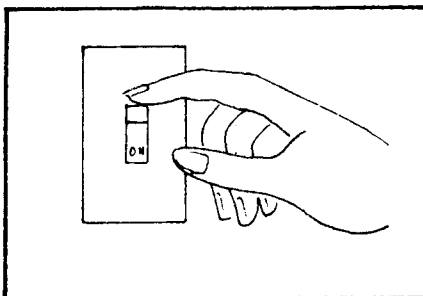

Turn fixture off at wall switch.

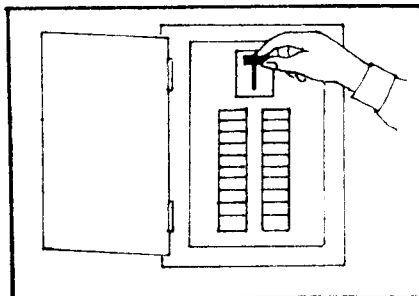

Go to the main fuse box in your home. If your fuse box has an ON/OFF switch, simply place the main power switch in the OFF position.

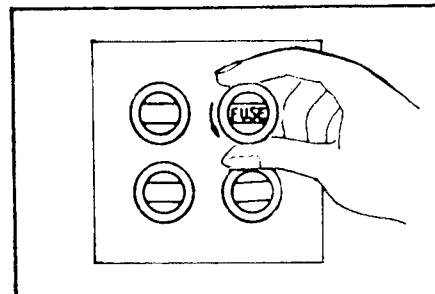

If your fuse box has screw-in type fuses, unscrew the fuse or fuses which control the power to the fixture or the room you are working in.

INSTALLATION INSTRUCTIONS

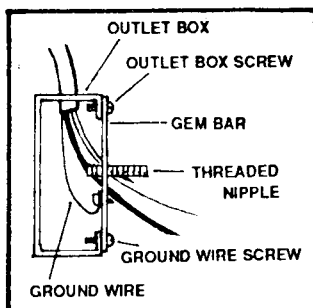

For new installations remove existing screws from the outlet box. For replacement fixtures remove old gem bar. Assemble 2 mounting screws (provided) with gem bar as shown. Attach ground wire to gem bar with screw. Then fasten gem bar to

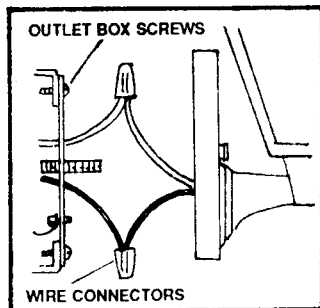

Connect the wires. **IMPORTANT;** Attach black fixture wire to black supply wire; white fixture wire to white supply wire. Use connectors (not provided) to seal connection.

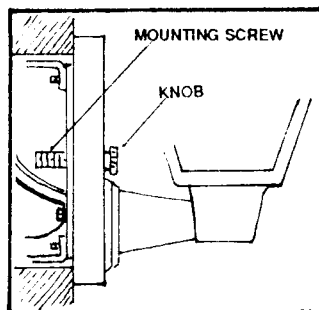

Assemble fixture over mounting screw and secure with knob. Screw bulb into socket.

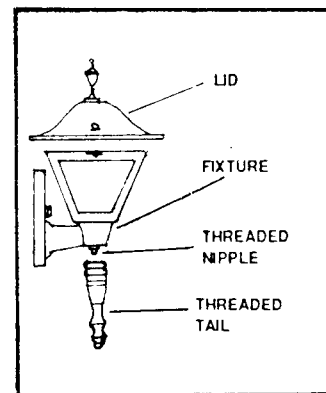

Assemble lid to fixture and secure with knobs. Assemble tail to fixture by screwing threaded tail onto threaded nipple and tighten.

