

## Before you start



### CAUTION



Many new and factory radios require a reset code when disconnected from battery power. This is an anti-theft feature. Before unplugging power, you must determine if your radio/source unit requires a reset code. Check the operation manual for your vehicle or contact the dealer.

## Power cable size and fusing

It is critical to use the proper power and ground cable. Select the size listed here for your amplifier model. Always use high quality copper cable. Visit our website for multi amp system cable recommendations.

Be sure to use the proper fuse size for each model. Some models require an external fuse.

Model	Fuse Size	Cable Size
<b>NA2-400.2</b>	1-30A atc	<b>10ga</b>
<b>NA2-320.4</b>	1-30A atc	
<b>NA2-400.1</b>	1-30A atc	
<b>NA2-500.5</b>	1-40A atc	

For power cable runs over 20 feet, 8ga is recommended.

## Installation

### 1 Disconnect Negative Battery Terminal

Place terminal in a secure position so that it won't accidentally contact the negative battery post

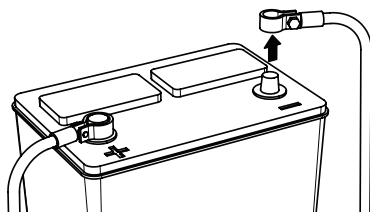

### 2 Run Cables

Properly route power, speaker and RCA cables through the vehicle.

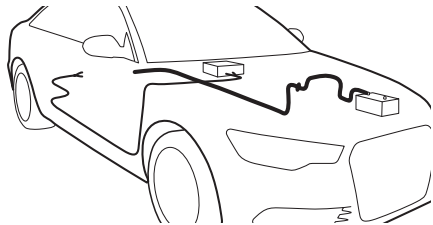

### 3 Mount Amplifier

Choose a mounting location that will provide adequate air ventilation. Mount the amplifier to a secure surface. Do not mount the amplifier upside down.

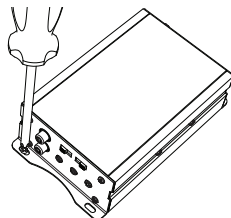

### 4 Chassis Ground



The chassis ground connection is critical to the performance of the amplifier. Choose a location that is close to the amplifier. Completely scrape away the paint and use a nut and bolt if possible. **DO NOT USE AN EXISTING FACTORY BOLT!**

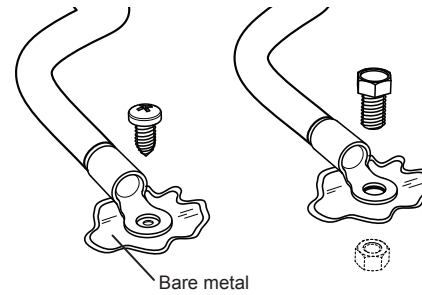

Bare metal

### 5 Power Connection

Attach the chassis ground, +12V and remote wire. It is important to make sure these connections are very secure.

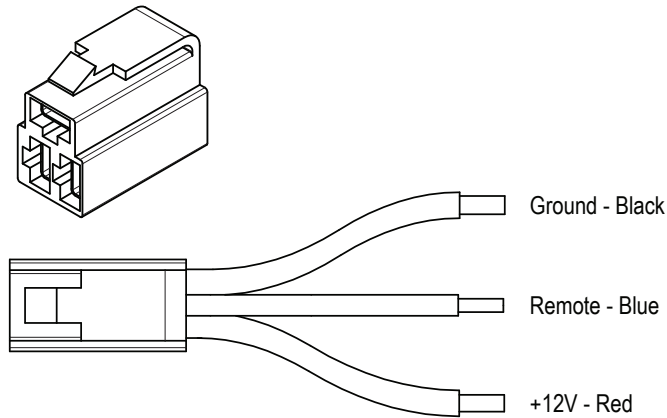

### 6 Signal Input Connection

Connect the RCA cables to the INPUT connectors. The OUTPUT can be used to provide input for a second amplifier.

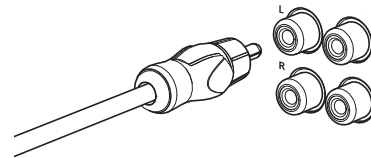

### 7 Gain Control

Turn the GAIN control completely counter-clockwise to minimum.



### 8 Speaker Connections

Connect the speaker cables to the speaker output connectors. Follow the diagram below that best fits your speaker configuration.

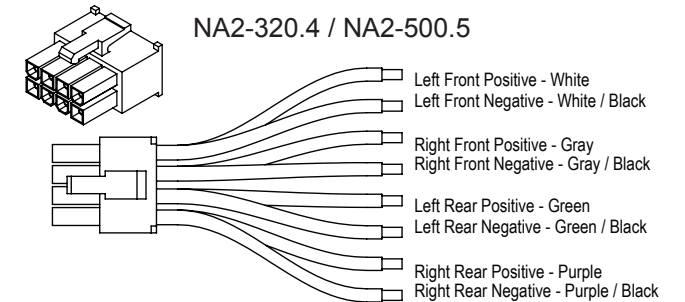
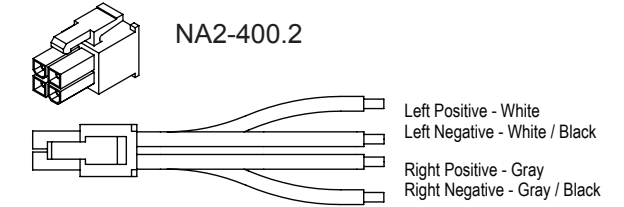
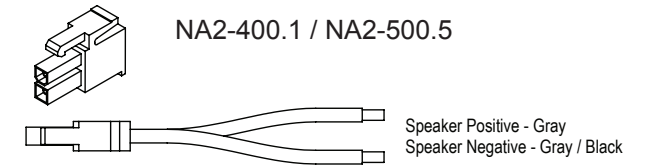

### 9 Positive Battery Connection

Connect the power cable to the positive battery terminal. The power cable must be fused within 18 inches of the battery terminal.

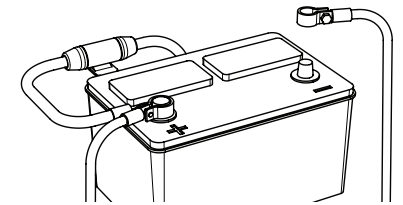

**Be prepared to disarm your vehicle's alarm and to enter your radio / source unit code.**

### 10 Re-connect Negative Battery Terminal

Re-connect the negative battery terminal making sure it is securely tightened.

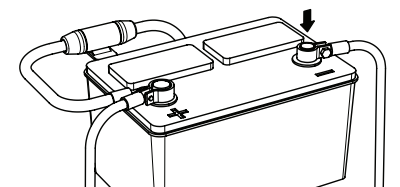

# Setup

**A**

## Settings

The illustrations below describe the various controls. Refer to the illustration that matches your amplifier.

### 1 GAIN Adjustment

The gain control purpose is to match the output of your source signal to the amplifier. Refer to the section B below for detailed instructions.

### 2 X-OVER Switch

This switch will set the amplifier to have a full frequency output or to filter out high or low frequencies. The NA1-400.2 offers either a bandpass or a high pass filter.

### 3 Frequencies Adjustment

The Low Pass Filter will cut off the frequencies above the setting. The High Pass Filter will cut off the frequencies below the setting.

### 4 SUBSONIC Adjustment

The Subsonic Filter will cut off the frequencies below the setting. If using with a subwoofer the setting should be kept between 15-25Hz.

### 5 BOOST Switch

The Boost Switch will increase the signal 12dB at 45Hz. Be aware this setting can cause distortion if the gain is not set properly.

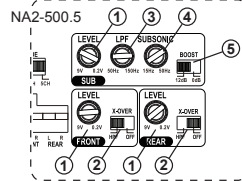
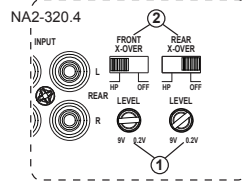
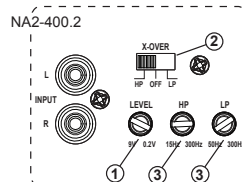
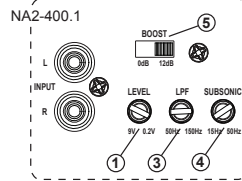

**B**

## Level Setting

This is a critical step to insure your amplifier is properly adjusted to match the signal output level of your source unit.



**THIS IS NOT A VOLUME CONTROL!**

1. If possible, with the source unit off, confirm that the primary volume control is turned down (counter clockwise).
2. Turn on the source unit (CD, or MP3 player). Re-confirm that the volume is turned down. Make sure the source unit controls; balance, fader, bass and treble are all set to center or "0" adjustment. Make sure that the green LED on the end of the amplifier is illuminated.
3. Play a clean musical selection of which you are very familiar. CD is preferred. Do not use radio signals for level setting. Hit play and start turning the volume of the source unit up.
4. Stop increasing the source unit volume when you reach 3/4 (about 75%) or until you hear speakers begin to slightly start producing distortion.
5. Increase the amplifier gain (clockwise) until distortion is heard, then back the level down (counter clockwise) until the distortion is eliminated. Small adjustments may need to be made to balance the levels of multiple amplifiers.



MBQuart.com  
#MUSIC DEFINED

The information contained within this document is intended to offer some basic guidelines for a few of the most common installations. More complex audio systems should be installed by a competent professional. Additional installation information available at [www.maxxsonics.com](http://www.maxxsonics.com)

### WARRANTY

Maxxsonics USA Inc. warrants this product, to the original consumer purchaser, to be free from defects in material and workmanship for a period of one (1) year from the date of purchase. Maxxsonics USA Inc. will, at its discretion, repair or replace defective products during the warranty period. Components that prove to be defective in materials and workmanship under proper installation and use must be returned to the original authorized Maxxsonics USA Inc. retailer from where it was purchased. A photocopy of the original receipt must accompany the product being returned. The costs associated with removal, re-installation and freight are not the responsibility of Maxxsonics USA Inc. This warranty is limited to defective parts and specifically excludes any incidental or consequential damages connected therewith. To view the full warranty, please visit the website.

MBQuart products are designed and engineered in the USA by  
**MAXXSONICS**

# MBQUART

MUSIC. DEFINED.

## Quick Start Installation Guide

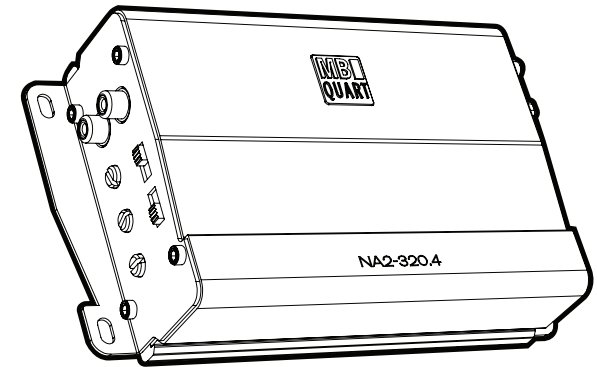

NA2-400.2  
NA2-320.4  
NA2-400.1  
NA2-500.5

Congratulations on your choice of a MBQuart amplifier. This "Quick Start Installation" guide is meant to help you "hook up" and play music. For more detailed information, on system setting, speaker and subwoofer configuration and full specifications by model visit the website, <http://mbquart.com/manuals.html>