

| Item | Description         | Qty |
|------|---------------------|-----|
| A    | Bracket, Passenger  | 1   |
| B    | Bracket, Driver     | 1   |
| C    | Rear Shock Brackets | 2   |

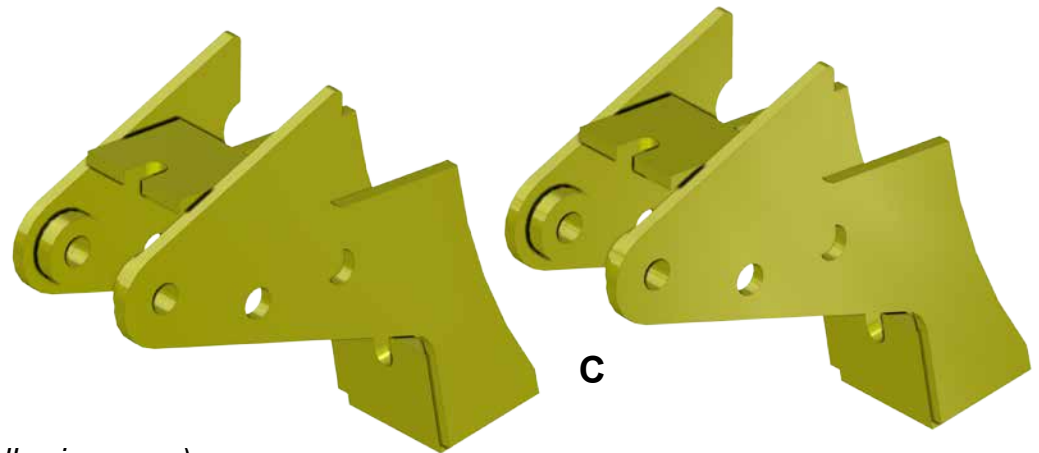
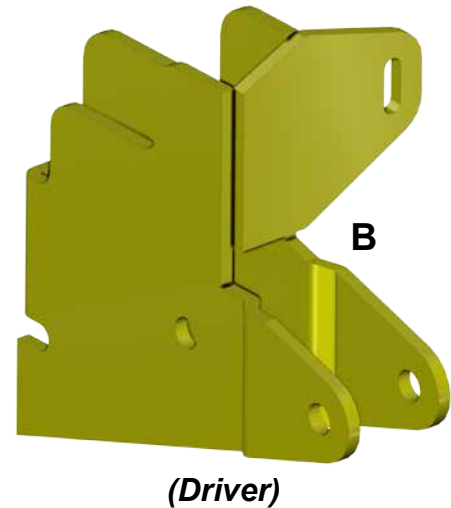
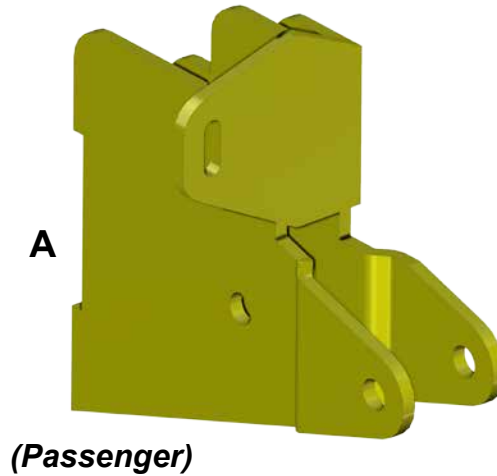

*(kit contents continue on following page)*

**Read instructions and view illustrations before beginning.**

**Need help with your installation?**



sales@superatv.com



www.superatv.com



1-812-574-7777



8:00am - 9:00pm EST M-Th  
8:00am - 7:00pm EST Friday  
9:00am - 2:00pm EST Saturday

*Thank You  
For Choosing*

**Liability Statement**

SuperATV's products are designed to best fit users ATV/UTV under stock conditions. Adding, modifying, or fabricating any factory, or aftermarket, parts will void any warranty provided by SuperATV and is not recommended. SuperATV's products could interfere with other aftermarket accessories. If user has aftermarket products on machine, contact SuperATV to verify that they will work together.

Although SuperATV has thousands of satisfied customers, user should be aware that installing lift kits, long travel, or suspension kits, tires, etc will change the ride of machine and may increase maintenance and part wear. Operating any off-road machine while, or after, consuming alcohol and/or drugs increases risk of bodily harm or death. No warranty or representation is made as to this product's ability to protect user from severe injury or death. SuperATV urges operators and occupants to wear a helmet and appropriate riding gear at all times.

By purchasing and installing SuperATV products, user agrees that should damages occur, SuperATV will not be held responsible for loss of time, use, labor fees, replacement parts, or freight charges. SuperATV, nor any 3rd party, will not be held responsible for any direct, indirect, incidental, special, or consequential damages that result from any product purchased from SuperATV. The total liability of seller to user for all damages, losses, and causes of action, if any, shall not exceed the total purchase price paid for the product that gave rise to the claim.

SuperATV will warranty only parts provided by SuperATV. Any damage or problems with OEM housings, bearings, seals, or other manufacturers products will not be covered by SuperATV. SuperATV parts and products are not warranted if item was not installed properly, misused, or modified.

(kit contents continued)

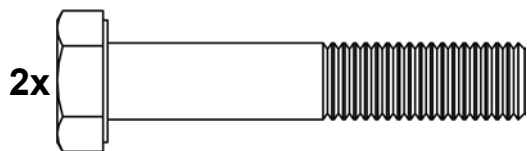

2x M10-1.50 x 55mm Lg.

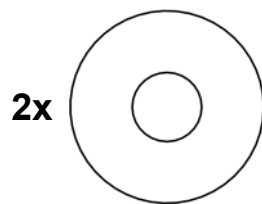

2x M8 Washer



2x M10-1.50 x 65mm Lg.



2x M8-1.25 Nylock Nut

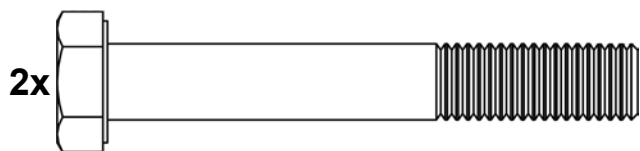

2x M10-1.50 x 70mm Lg.

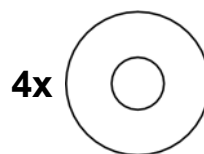

4x M6 Washer

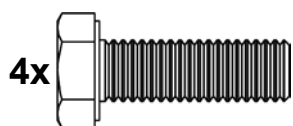

4x M8-1.25 x 25mm Lg.

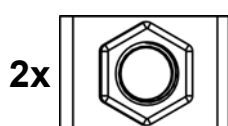

2x M8-1.25 Clip Nut



2x M6-1.0 x 25mm Lg.



6x M10-1.50 Nylock Nut



2x M6-1.0 Nylock Nut

### **IMPORTANT!** For Commander X Models:

Disconnect Front Sway Bar from Lower A-Arms before beginning installation.  
Reconnect when installation is complete and machine is on ground.

- ***Keep all components removed from machine.***
- ***Do not tighten hardware completely unless noted.***

## **Front Installation:**

1. Raise front of machine off ground, secure with jack stands, and remove Wheels.
  - Disconnect end of Air Hose as shown in Fig. 1.
2. Install Bracket, Passenger (A) to Frame with M6-1.0 x 25mm Lg. HHCS, M6 Washers, and M6-1.0 Nylock Nut. See Fig. 2.
  - Use stock Shock hardware to secure Bracket to stock Shock mounting hole in Frame. See Fig. 2.
  - Complete installation of Bracket, Passenger (A) with M8-1.25 x 25mm Lg. HHCS, M8 Washer, and M8-1.25 Nylock Nut. See Fig. 2a.
  - Repeat steps for opposite side.
3. Install Shocks to Brackets (A)(B) with M10-1.50 x 55mm Lg. HHCS and M10-1.50 Nylock Nuts. See Fig. 2.
4. Tighten all hardware completely. Reinstall Wheels.



*(illustrations continue on following pages)*

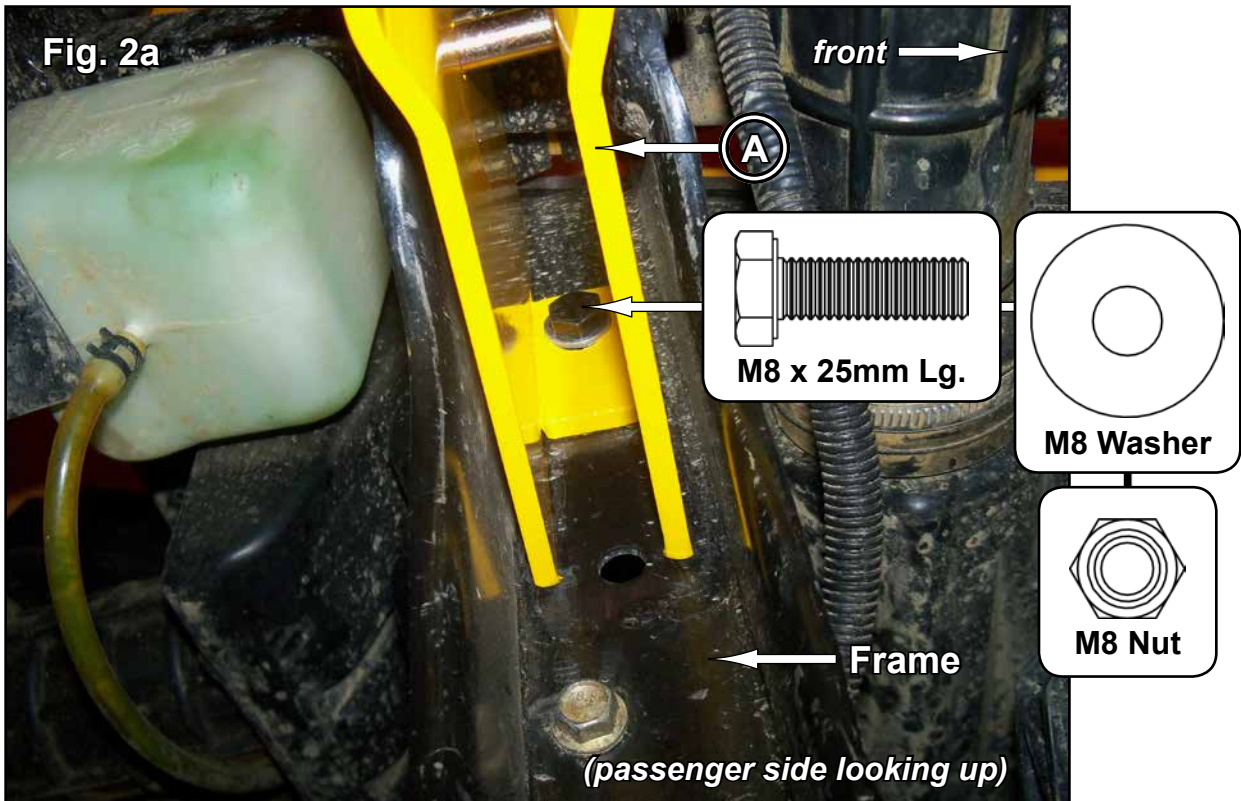
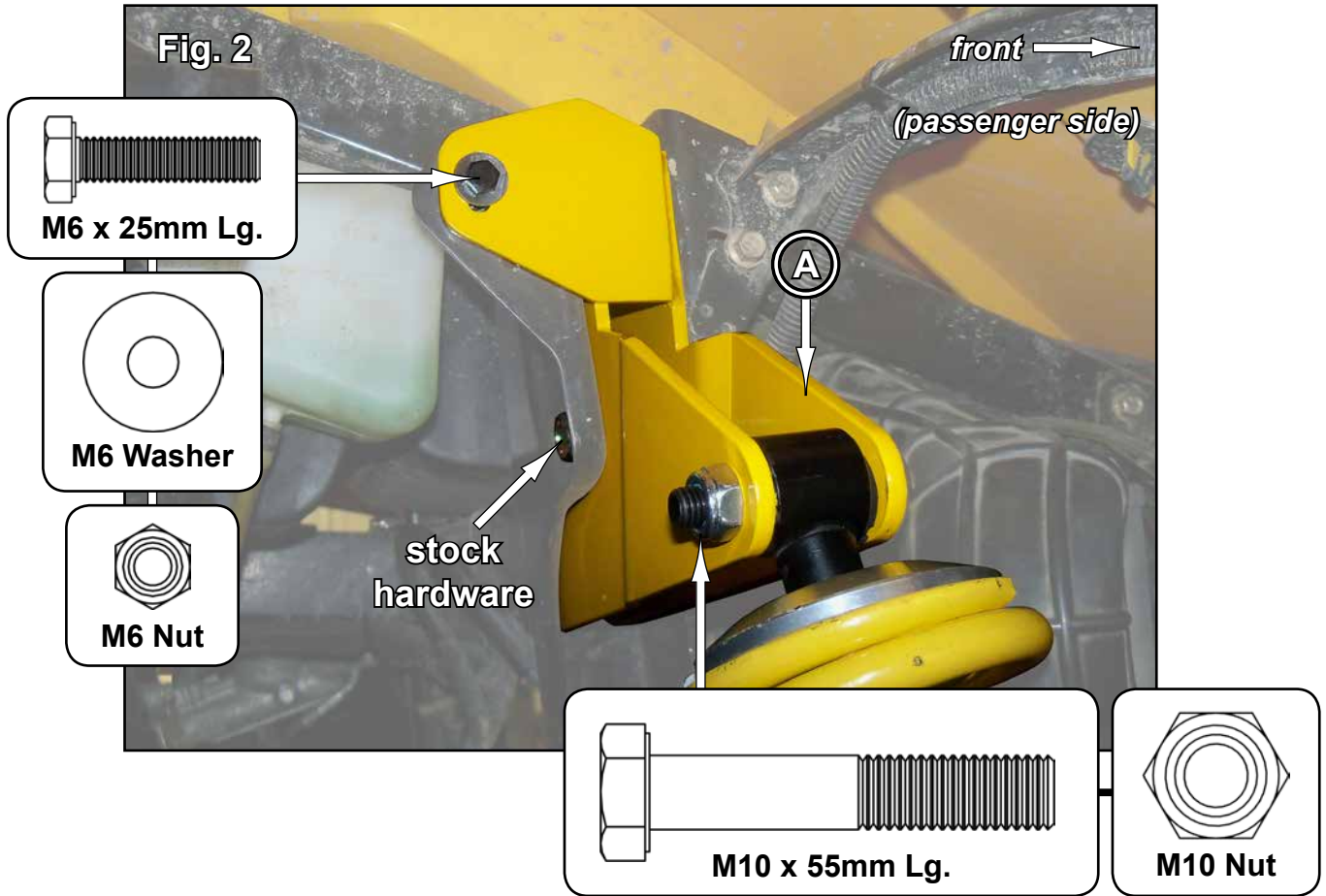



## Rear Installation:

1. Raise Cargo Box and remove Bed Stops.
  - Raise rear off ground; secure with jack stands.
  - Remove Wheels.
  - Remove Shocks from Shock Mounts.
2. Install Clip Nuts into stock Shock Mounts. See Figs. 3 - 3b.
3. Install Rear Shock Brackets (C) to stock Shock Mounts with M8-1.25 x 25mm Lg. HHCS. See Figs. 3 - 3b.
  - Use M10-1.50 x 65mm Lg. HHCS and M10-1.50 Nylock Nuts to secure Rear Shock Brackets (C) to stock Shock mounting hole See Figs. 3 - 3b.
4. Reinstall Bed Stops. See Fig. 4.
5. Install Shocks to Rear Shock Brackets (C) with M10-1.50 x 70mm Lg. HHCS and M10-1.50 Nylock Nuts. See Fig. 4.
6. 2014+ years will require Differential Vent Tube rerouting. Reroute and secure to Rear Bracket (C). See last page of instructions.
7. Tighten all hardware completely. Reinstall Wheels.

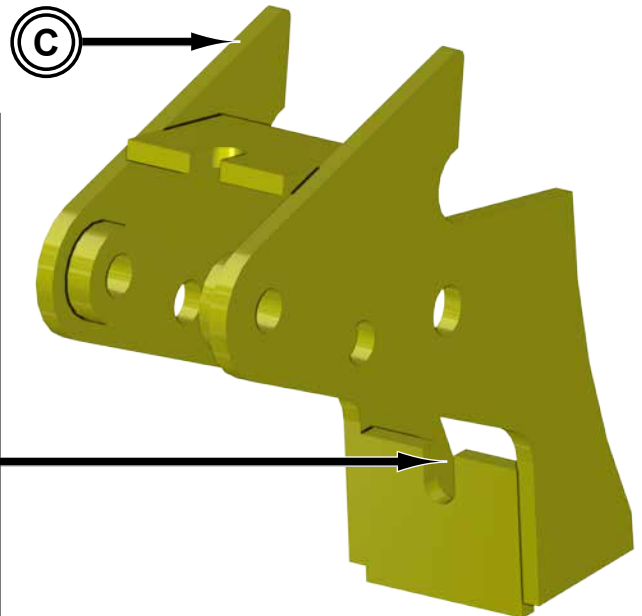
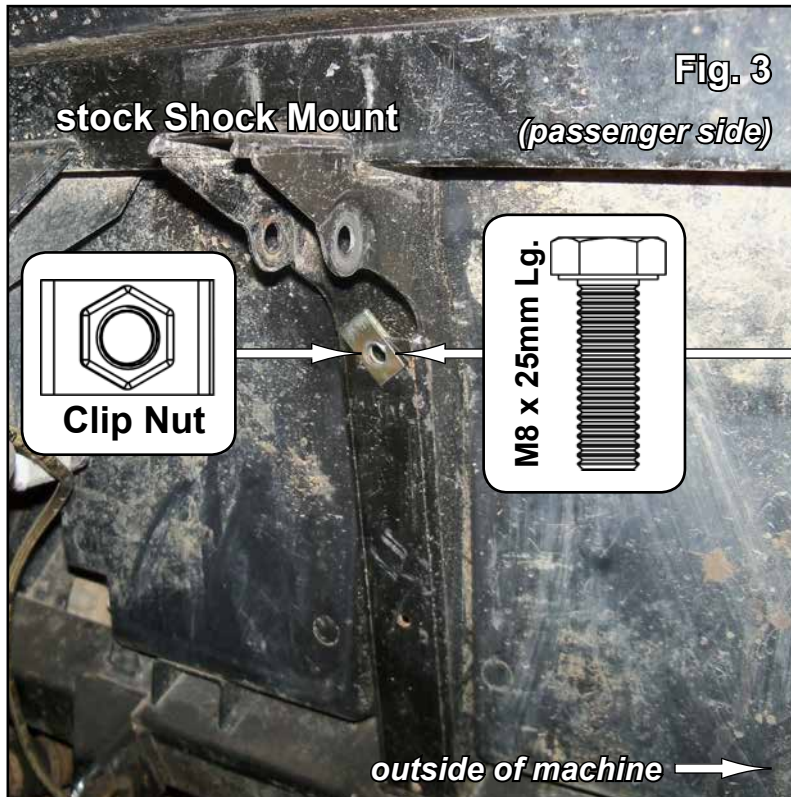

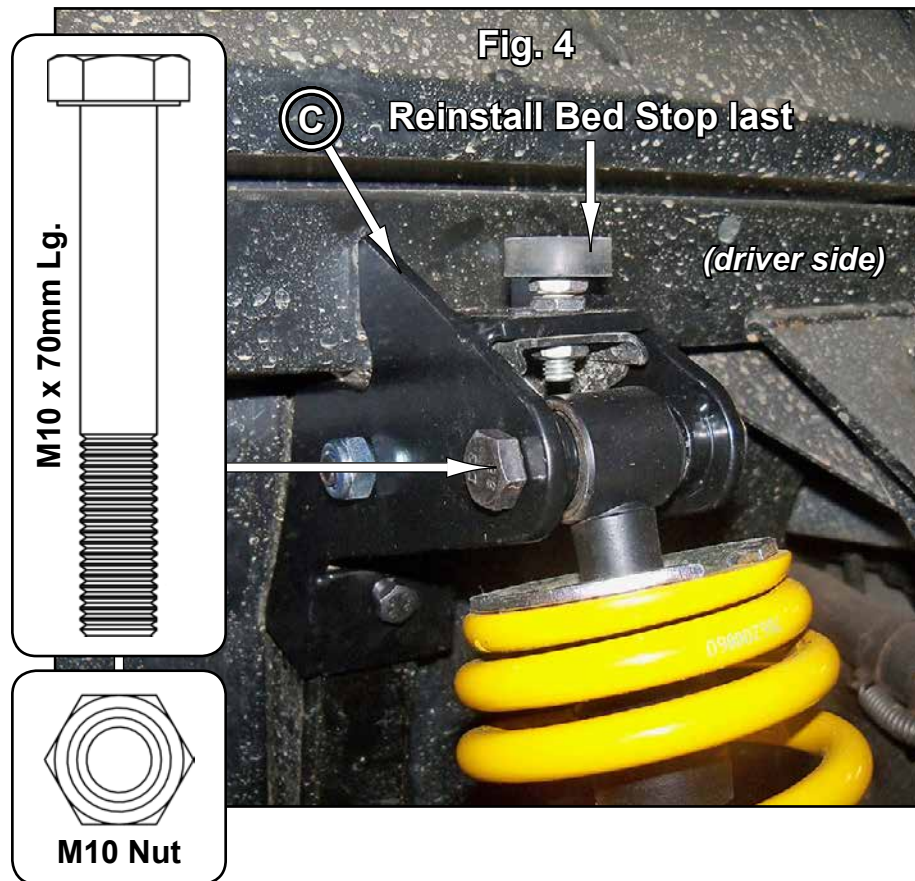
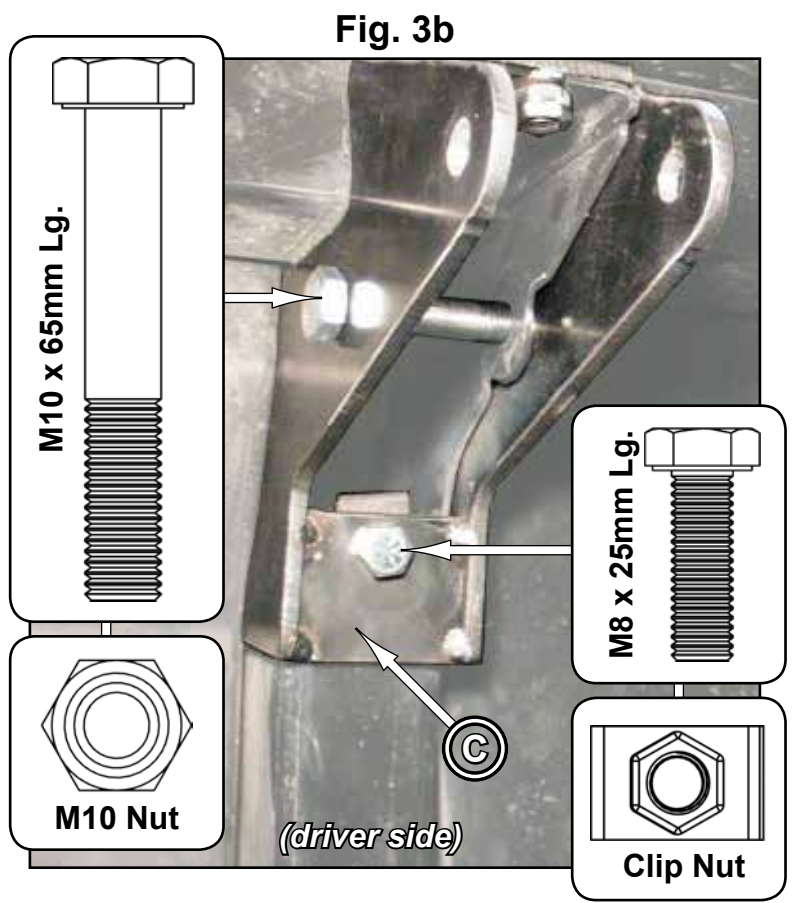



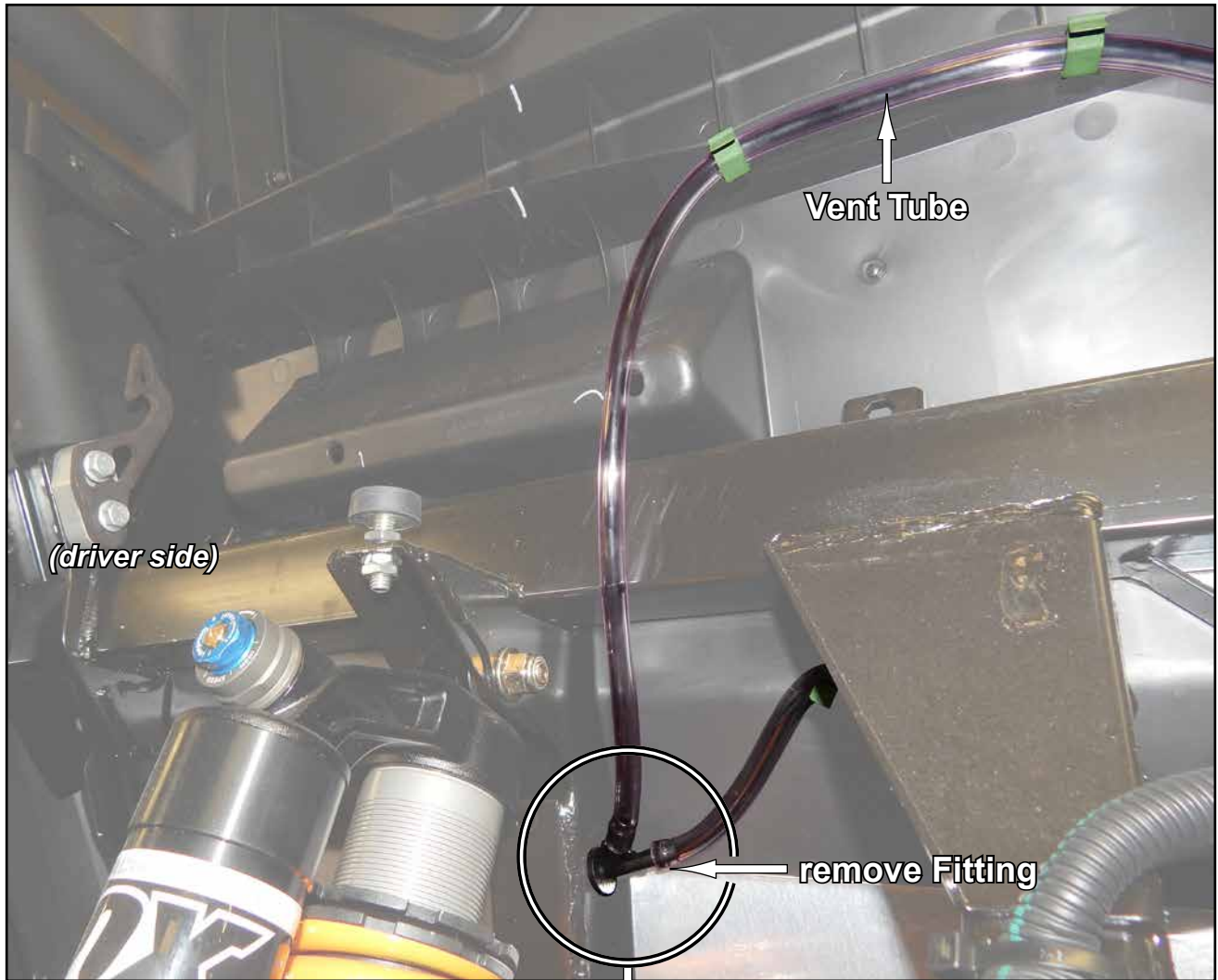

Rear Bracket contains mounting location for stock Vent Tube Mounting.  
2014+ years will need to reroute and connect.

