

Description:	Quantum® Hardcoated Polycarbonate UTV Windshield, Low	Model:	Polaris RZR 800
Part Number:	N30200	Installation Time:	15 min.

Thank you for purchasing a National Cycle product. Read these instructions carefully and thoroughly before beginning work. Dealers, if installing this windshield for a customer, please give them this manual. It contains information needed to properly maintain and use this product.



Attention:
Special notes and cautionary measures which can prevent damage to the accessory or vehicle.



Note:
Tips for facilitation of operation, control and adjustment, as well as maintenance work.

Parts List

Tools Required

Item	Part No.	Description	Qty.	Notes and Tools
1	20-290394-000	Low Windscreen	1	Grommets and Velcro Fasteners Installed
2	44-447165-000	Grommet,	1	Installed on Windscreen
3	77-771152-001	Marine Grade Velcro, Hook, 11" L	1	Installed on Windscreen
4	77-771153-001	Marine Grade Velcro, Loop, 11" L	1	Installed on Windscreen
Bag#1135				
5	44-449370-000	Clamp, Wraparound	4	
6	44-449380-000	Retaining Pin	4	
7	49-490355-000	Washer, Flat, Black	4	
8	55-563131-000	Screw, Phillips, #12 x 1.25,	4	#2 Phillips Screw Driver

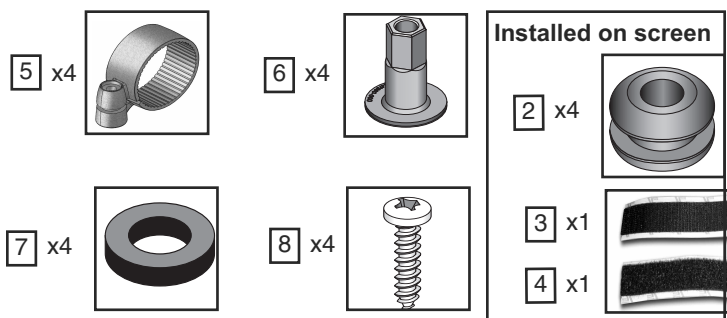

PREPARATION

This Kit has been carefully packed and inspected at the factory. Report any missing part directly to National Cycle, Inc. along with the Bag No. and Date on outside of Windshield Carton.

Carefully unpack the windshield, sort the parts, and make sure you have everything required to complete the installation to the vehicle.



Figure 1

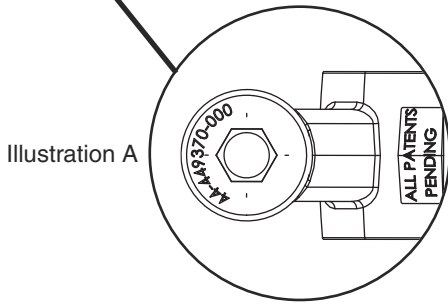

Illustration A

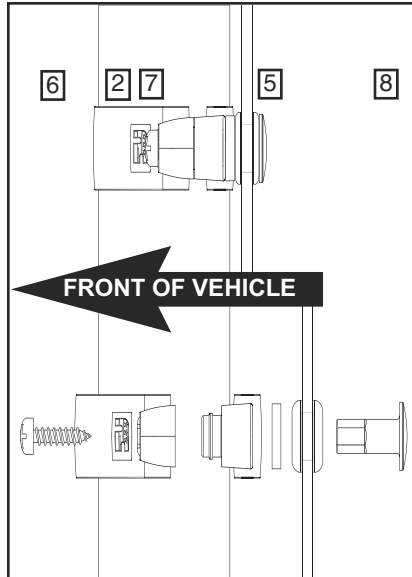

Illustration B



Figure 2

INSTALLATION

Position Clamps, Place Windshield on Hood Illustration A, Figure 1

Snap the four Wraparound Clamps (5) on the frame of the vehicle as shown in Figure 1. Orient the clamps so that the male half (with embossed part number) is toward the front of the vehicle.

 Place fasteners within reach of assembling clamps.

Position the windshield on the hood and against the front frame of the vehicle.

Install Fasteners, Illustration B, Figure 2

Loosely install Windshield at sides using:

Retainer Pin (6)

Black Washer (7)

(#7 place between Shield Grommet and Clamp)

Screw (8)

(Phillips Screw Driver)

 Note the Hex shape of Retainer Pin, and male Clamp half.

Repeat the same procedure for the remaining three clamps.

Check Alignment

Check the alignment and position of the windshield and make sure it is even and symmetrical.

 The tabbed section of the windshield should be touching the hood of the vehicle.

Install Windshield to Hood of Vehicle, Figure 3

Remove the adhesive backing from the Velcro loop material and then press the windshield tab firmly onto the hood of the vehicle.

Final Tightening

Securely tighten the Machine Screws in the four Wraparound Clamps.

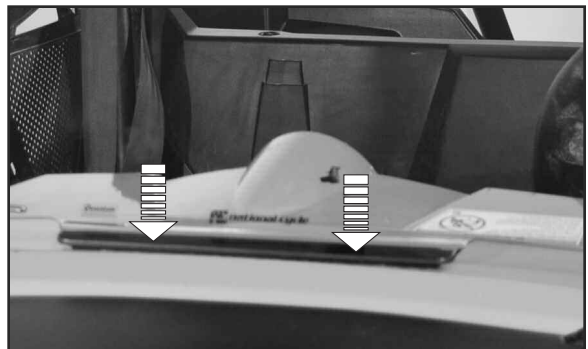

Figure 3



CLEANING AND MAINTENANCE

To clean the screen, wash with a clean soft cloth, plenty of warm water and if necessary, a non-abrasive soap such as dishwashing liquid. Flannel or soft chamois make good cleaning cloths. **Paint, glue residue or grease removal:** Moisten cotton with naphtha or turpentine followed by a wash as above.

National Cycle **Shield Wash™** (N1401-01) makes a good daily cleaner and comes with a handy travel size bottle. Shield Wash is safe for all windshields and helmet visors.

Do not clean polycarbonate in hot sun or high temperatures. Do not clean the screen with glass cleaners.

Do not allow brake fluid, alcohol, or strong solvents to contact the screen.

RAIN REPELLENT

Do not use rain protective products made for glass. We recommend National Cycle's **RainZip®** (N1410-01) to help shed water in rainy weather.



Register your windshield online at www.nationalcycle.com

National Cycle's UTV Windshield 3-Year Limited Warranty

National Cycle hereby warrants to the original registered owner of a National Cycle polycarbonate windshield for a period of three years from the date of purchase against breakage. This limited warranty is expressly limited to the replacement of the polycarbonate windscreen. This limited warranty does not include scratches, coating failure, cosmetic wear and tear, replacement of hardware, or any consequential damages or expenses including labor cost of installation, removal and/or replacement, inconvenience, inbound or replacement outbound freight expenses (outbound freight must be paid in advance by cc or check) or damage to any other component of the vehicle or any other accessories. Certain chemicals, generally known as acidic hydrocarbons, are known to cause polycarbonate damage and will not be covered under this limited warranty. Please refer to the cleaning instructions supplied with your UTV Windshield.

⚠ WARNING

CAUTION: The maximum speed for trailering the vehicle with the windshield is 65 MPH minus headwind speed. Always face windshield forward (in direction of travel) while carrying on truck or trailer.

CAUTION: Plasticizers from some new vehicle covers or other coverings that are made from PVC may damage your windshield. Do not use a new cover for a few days. Remove it from its package and leave in the sun or other warm location. Use caution when storing your vehicle covered with your windshield installed, to avoid gases from becoming trapped under the cover.

Do not clean polycarbonate in hot sun or high temperatures. Do not clean the screen with glass cleaners.

Certain chemicals, generally known as acidic hydrocarbons, are known to cause polycarbonate damage. Do not allow brake fluid, alcohol, or strong solvents to contact the screen.

RAIN REPELLENT

Do not use rain protective products made for glass. We recommend National Cycle's **RainZip®** (N1410-01) to help shed water in rainy weather.