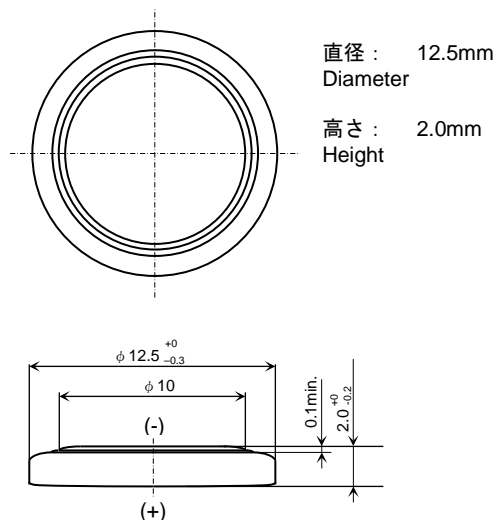
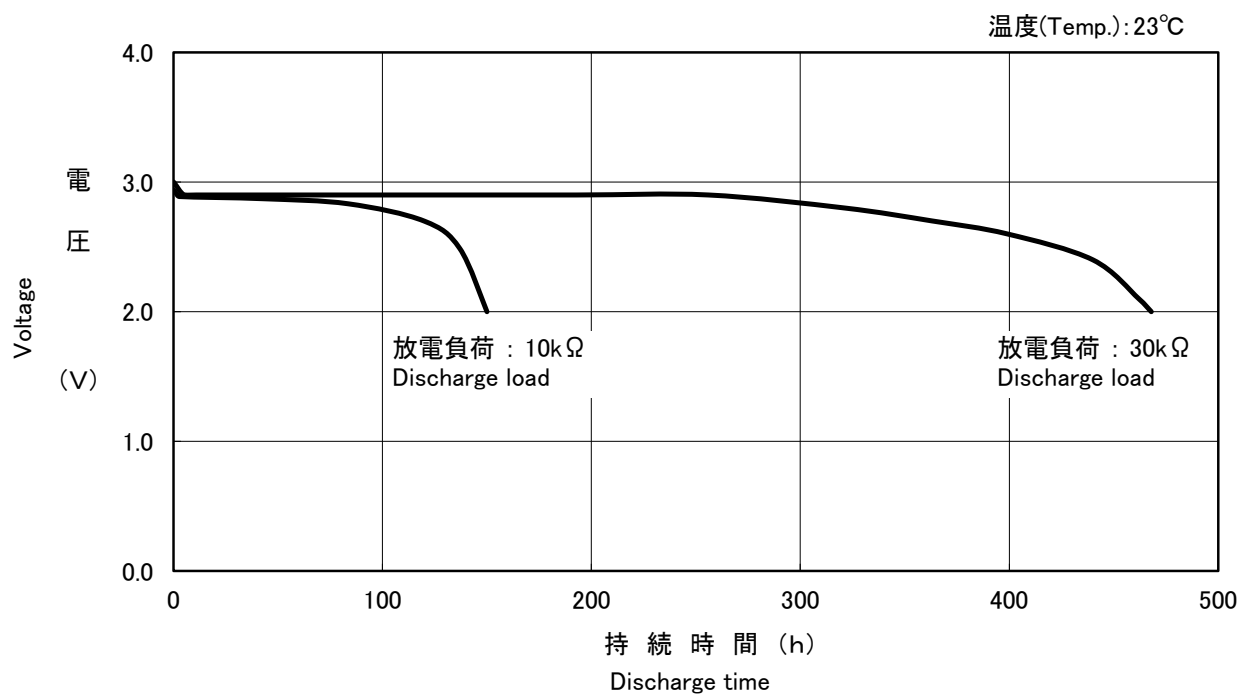

コイン形二酸化マンガンリチウム電池
 Coin manganese dioxide lithium batteries

CR1220

外形寸法 Dimensions(mm)

定格 Specifications

公称電圧 Nominal Voltage	3V
公称容量 (終止電圧 2.0V) Nominal Capacity (2.0V cutoff)	40mAh
標準放電電流値 Standard Discharge Current	0.1mA
標準質量 Weight	0.8g
用途 Applications <ul style="list-style-type: none"> ● 時計 ● 電子手帳・電卓 ● SRAMやリアルタイムクロック等メモリーバックアップ ● Electronic Watch or Clock ● Electronic Calculator ● Memory Back-up Power Source for SRAM or Real Time Clock (RTC) 	

放電特性 Discharge Characteristics

■放電負荷特性

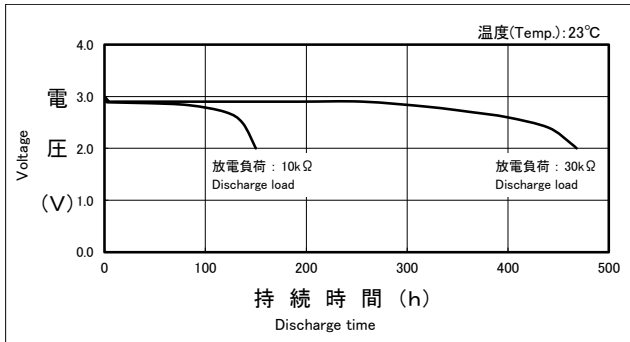
Discharge Characteristics on Load



■放電温度特性

Discharge Characteristics on Temperature

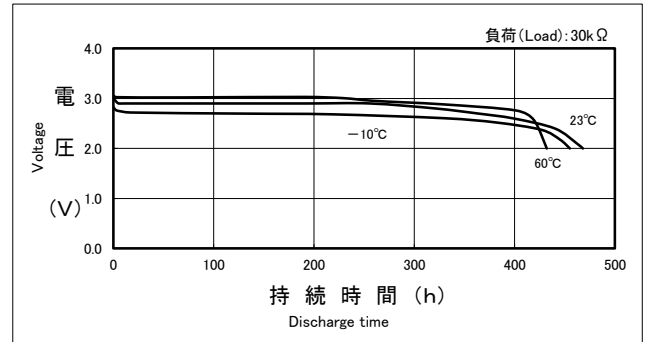

■放電負荷と作動電圧 (放電深度 40%時の電圧)

Discharge Load vs. Operation Voltage (Discharge depth 40%)

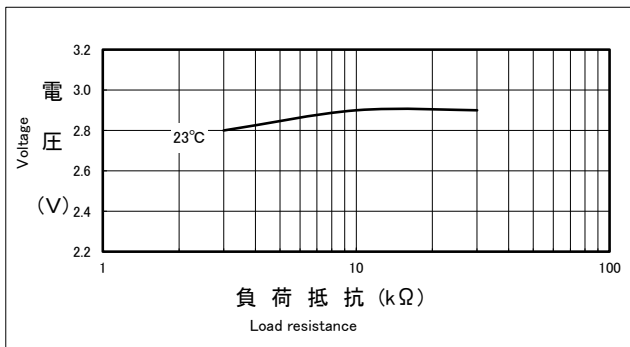

■放電負荷と電気容量

Discharge Load vs. Discharge Capacity

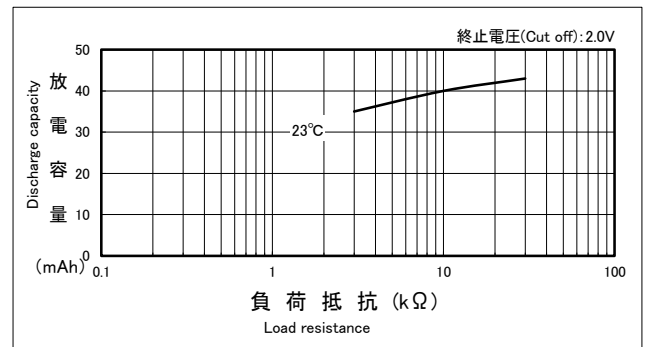

■パルス放電特性 (放電深度 40%時のパルス電圧)

Discharge Characteristics on Pulse Load (Discharge depth 40%)

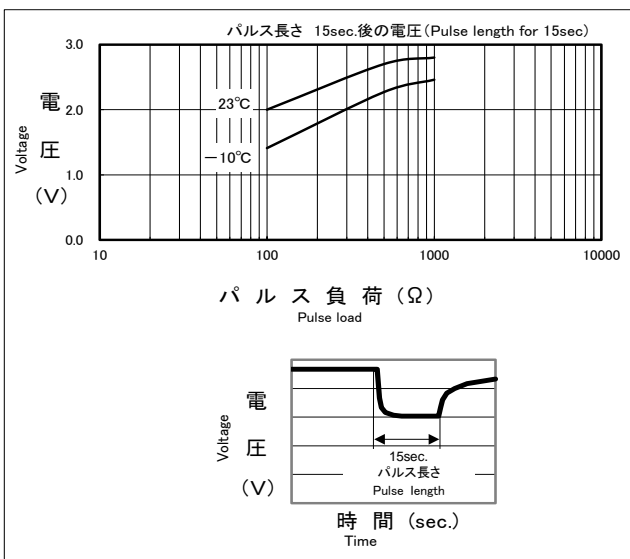

■保存特性

Storage Characteristics

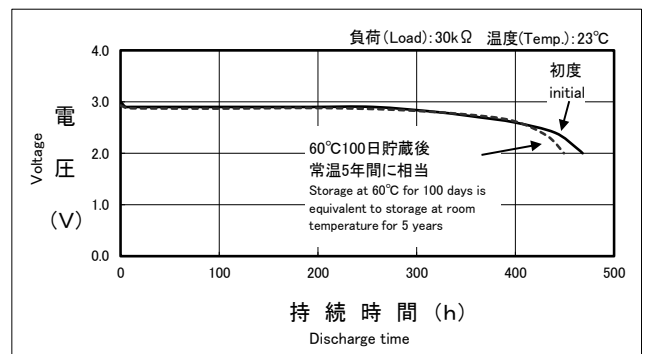

*記載のデータ及び数値は、参考値であり保証値ではありません。

*Data is not guaranteed, and is provided for reference purposes only.