

ENERGIZER E91

AA



Specifications

Classification:	Alkaline
Chemical System:	Zinc-Manganese Dioxide (Zn/MnO ₂) No added mercury or cadmium
Designation:	ANSI-15A, IEC-LR6
Nominal Voltage:	1.5 volts
Nominal IR:	150 to 300 milliohms (fresh)*
Operating Temp:	-18°C to 55°C (0°F to 130°F)
Typical Weight:	23.0 grams (0.8 oz.)
Typical Volume:	8.1 cubic centimeters (0.5 cubic inch)
Jacket:	Plastic Label
Shelf Life:	7 years at 21°C (80% of initial capacity)
Terminal:	Flat Contact

Industry Standard Dimensions

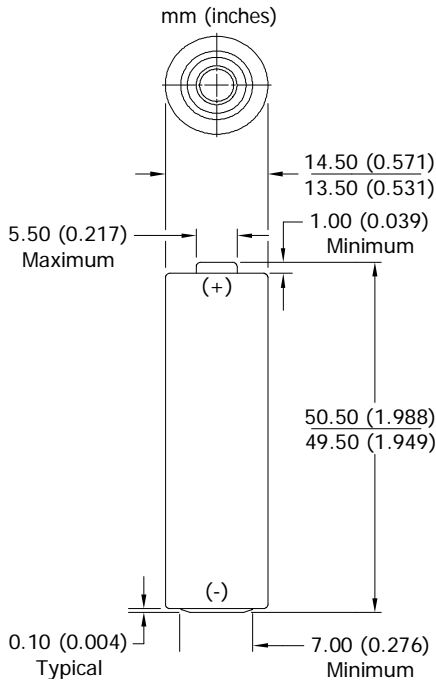

* For additional information, please reference the [IR technical white paper](#).

Milliamp-Hours Capacity

Continuous discharge to 0.8 volts at 21°C

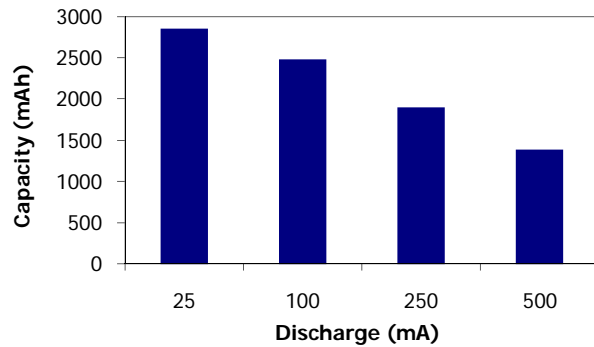

Device Selection Guide:

- Digital Camera 
- Photoflash 
- Games, CD's, MD's 
- Tape Player 
- Lighting 
- Toy 
- Remote Control 
- Radio 
- Clock 

Battery Selection Indicator

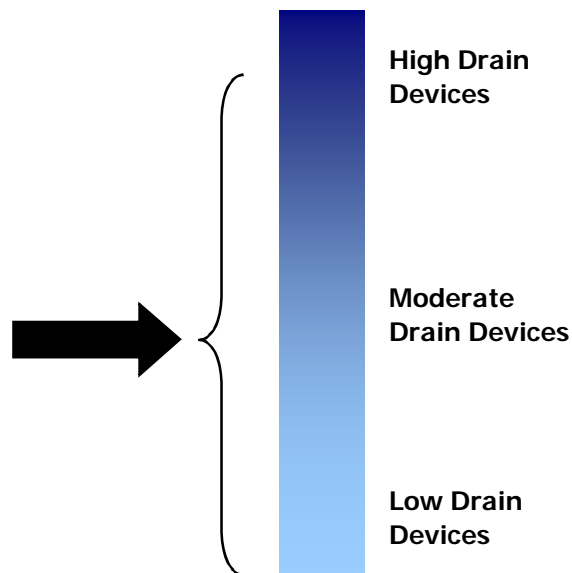

Important Notice

This data sheet contains typical information specific to products manufactured at the time of its publication.
©Energizer Holdings, Inc. - Contents herein do not constitute a warranty.

ENERGIZER E91

AA

Constant Power Performance

Typical Characteristics (21°C)

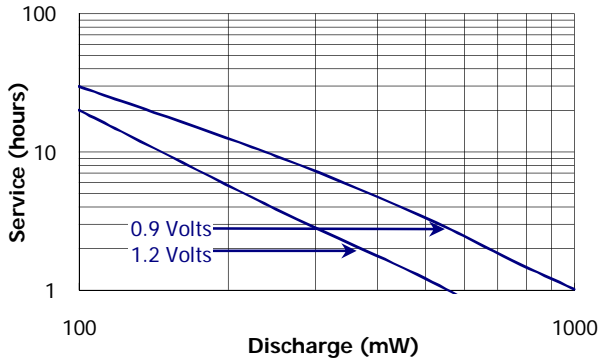

Constant Current Performance

Typical Characteristics (21°C)

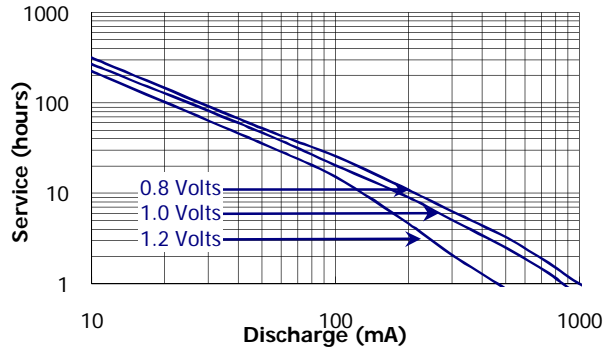

Constant Power Performance

Discharge Characteristics (21°C)

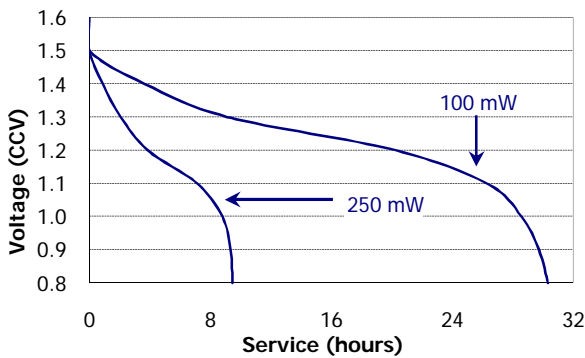

Constant Current Performance

250 mA Discharge (-20°C / 0°C / 21°C)

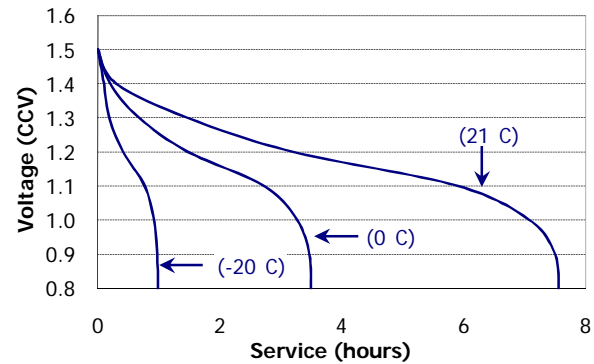

Industry Standard Tests (21°C)

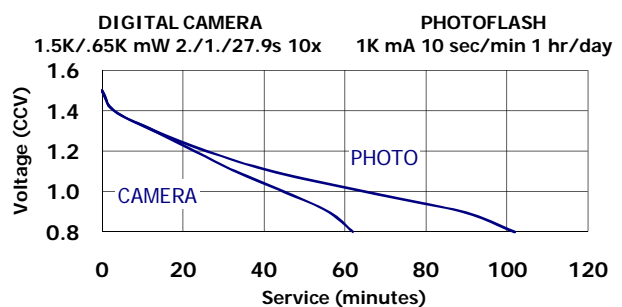
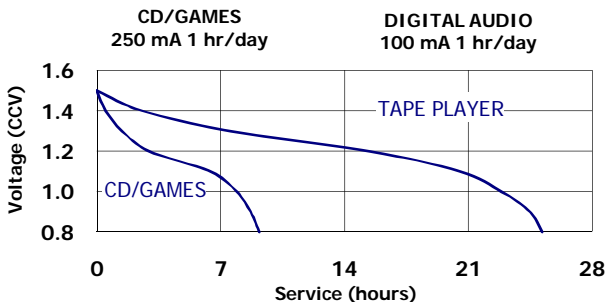
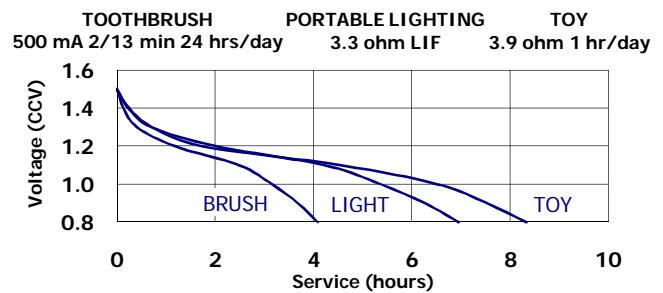
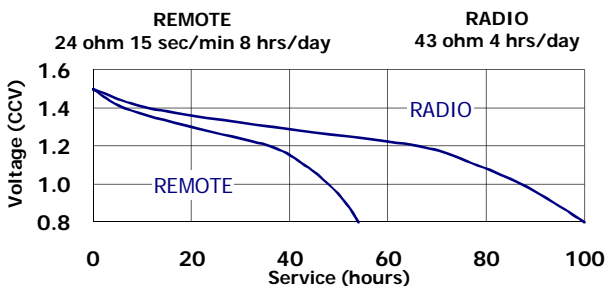

Important Notice

This data sheet contains typical information specific to products manufactured at the time of its publication.
©Energizer Holdings, Inc. - Contents herein do not constitute a warranty.