

ATTIC LADDER PRE-INSTALLATION GUIDELINES

EN

DIRECTIVES D'AVANT INSTALLATION D'ÉCHELLE DE GRENIER

FR

INSTRUCCIONES DE INSTALACIÓN PARA UNA ESCALERA DE ÁTICO

E



NC 617

LWS-M / LWS-P / LWF / OLN / OLN-P



**LWM / LWM-P
OWM / OWM-P**

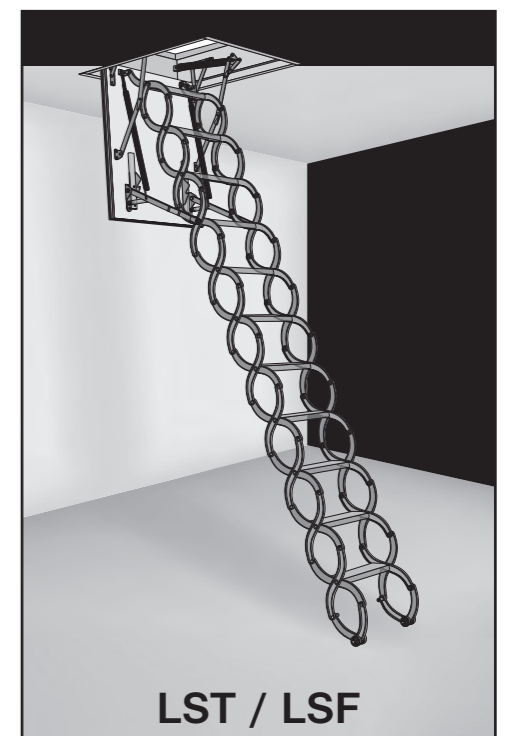

LST / LSF

INSTALLERS, CARPENTERS, CONTRACTORS



- **Read all warning notes. Warning notes contain important safety tips.**
- **In order to assure safe use of the attic ladder, proceed according to the installation instruction.**
- **The attic ladder is not safe to use, unless it is completely installed according to the following instructions.**

- I.** Important issues to considerpages 4
 - are you able to install attic ladder?pages 4
 - will attic ladder satisfy your expectations?pages 4
 - does the construction of your ceiling enables installation of the attic ladder?pages 4
- II.** Your package should containpages 5
- III.** Required manpower, tools and materialspages 5
- IV.** Finding a suitable locations for installationpages 6
- V.** Cutting a hole in the ceilingpages 7
- VI.** Cutting the ceiling joistspages 8
- VII.** Framing the installation openingpages 9
 - installing the single headerspages 9
 - double headerspages 10
 - installation of stringerspages 11

I. IMPORTANT ISSUES TO CONSIDER

Before you start any work read carefully all instructions, in order to make sure that you have a proper spot for installation and tools.

Are you able to install attic ladder?

In order to install this attic ladder, you need to know how to cut wood and use framing square. Not being able to do the above, installation of this product should be done by a professional installer (refer to yellow pages).

Will attic ladder satisfy your expectations?

The attic ladder has been designed only for home use. Installation of this product in commercial buildings can be obstructing to existing building codes. Before installation of this product consult with Fire Department or your local building inspector.

The attic ladder has been designed to be installed in room where the ceiling height is in the range described on the packaging. This product should not be installed if the ceiling height does not fit in the range described on the product's label. Modifications of the attic ladder can be dangerous.

Does the construction of your ceiling enables installation of the attic ladder?

The attic ladder can be installed in buildings with typical wood framed ceiling (Figure1). You should never cut any of the constructing elements of the ceiling without prior consultation with an architect (refer to yellow pages).

The attic ladder should not be installed in chosen spot if there is one of the following:

- air ducts
- metal constructions
- cement ceiling
- drop ceiling

If your ceiling has one of the above elements you can not install the attic ladder. In this case you should seek professional help.

The following instruction describes the installation method of the attic ladder.

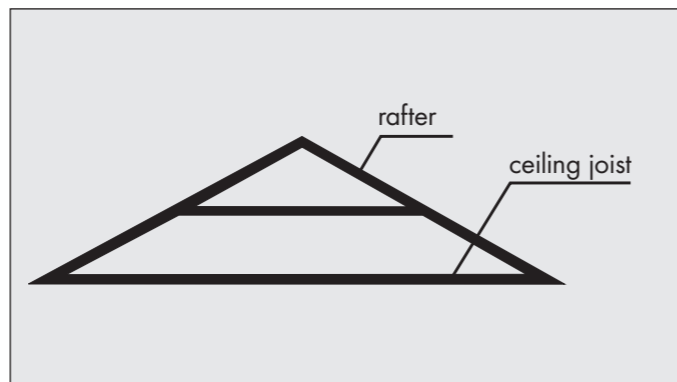

Fig.1. Typical roof construction

WARNING! DO NOT CUT THIS TYPE OF CONSTRUCTION (FIG. 2, 3) WITHOUT PRIOR CONSULTATION WITH AN ARCHITECT.

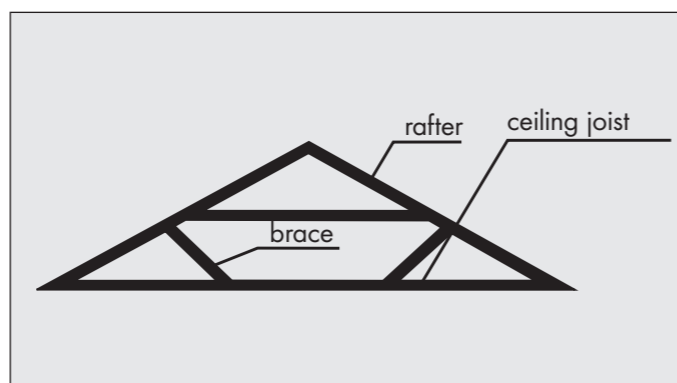

Fig.2. Typical construction of the roof with braces connected to the ceiling joists.

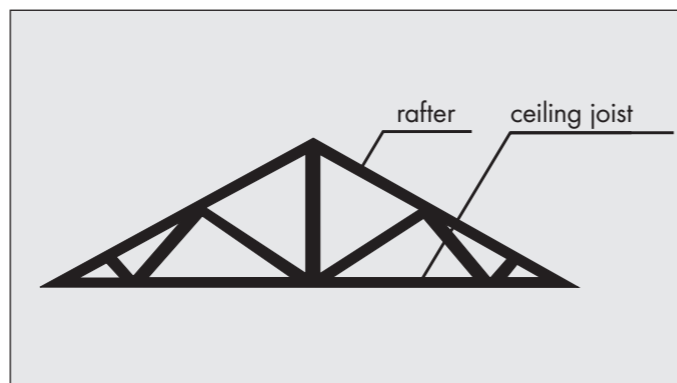

Fig.3. Truss roof frame.

II. YOUR PACKAGE SHOULD CONTAIN:

- Attic ladder fully assembled and ready for installation. You should not dismantle assembled product for installation
 - Control rod
- Prior to installation inspect the product for any cracks in the wood. Make sure that the metal elements are not damaged and securely fastened.

III. REQUIRED MANPOWER, TOOLS AND MATERIALS

Manpower

- 2 people (one must be able to lift 90 LB and carry it in to the attic)

Materials

- few pieces of joist-sized lumber
- 2 boards 1x4x36" for temporary support
- few boards for working platform in the attic space
- wood shim stock
- 20d sinker nails
- 4" screws for wood

Step ladder

Step ladder should be long enough to allow you to enter the overhead space. Make sure that the ladder will withstand your weight plus the weight of whatever you are carrying.

WARNING

You should be extremely cautious while climbing the ladder, other person should be holding the ladder preventing it from tipping over.

Tools

- flashlight
- claw hammer
- pencil
- hand saw
- tape measure
- framing square
- power drill
- 1/8" drill bit
- tools to cut opening in the ceiling

Safety equipment

- gloves
- safety goggles
- dust mask

IV. FINDING A SUITABLE LOCATION FOR INSTALLATION

Before you begin:

make sure that you have required tools, manpower, and the construction of the ceiling is suitable for installation of the attic ladder.

Look for a space free from obstacles and dangers. Make sure that the space will allow proper installation and use of the attic ladder.

Make sure that the length of the attic ladder is suitable for your ceiling height (Figure 4, Table 1).

STEP 1

Choose potential installation spot. Check dimension of the required opening, refer to the table 2 on page 5.

If the attic ladder will be installed in the garage consider the location of parked cars.

STEP 2

Check the swing clearance. Figure 4 and Table 1.

STEP 3

Check the landing space, so that both legs rest on the floor. Figure 4 Table 1.

STEP 4

If the attic ladder will fit between the ceiling joists and there is no need for cutting the joists proceed according to step 7 "Framing the installation opening" Page 7-9.

If it is necessary to cut the ceiling joist proceed according to step 6 "Cutting the ceiling joists" Page 6.

STEP 5

Go in to the attic space and locate the spot for installation.

You can find this location by listening for tapping from below or measure the space below and in the attic area.

STEP 6

In the installation spot you should do the following:

- check if there is enough room to work during the installation
- make sure there are no obstacles (ie. air ducts, electrical installations, etc.) in the attic area disabling safe installation and use of the attic ladder.

Warning

In order to check the attic area for the above mentioned obstacles and dangers put on a dust mask, safety goggles, gloves and proper clothes to prevent cuts caused by mineral wool. Next, slowly lift up the layer of insulation, do not inhale dust and other particles which might be dangerous to your health.

STEP 7

If in the chosen spot you find any obstacles, you should find another spot for installation or contact professionals to remove the obstacle (refer to yellow pages).

WARNING!

For your own safety do not sit on the ceiling nor the insulation - it was not design to carry load. Only the ceiling joists can withstand your weight. Mind sharp nails sticking out of the ceiling's construction. Do not nail anything in to the ceiling that can conduct electricity until you are sure that there are no electric wires. Contact with electric wires can be deadly.

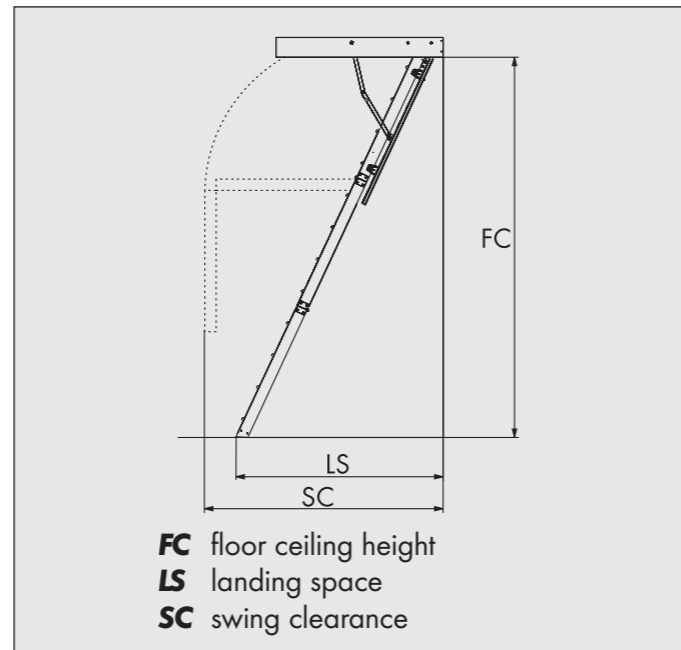

Fig.4. Characteristics of the attic ladder.

MODEL	SC	LS	FC
LWF 22/47	67 3/4"	57 1/2"	7'2" ÷ 8'10"
LWF 25/47	67 3/4"	57 1/2"	7'2" ÷ 8'10"
LWF 22/54	75 3/4"	64 1/2"	7'11" ÷ 10'
LWF 25/54	75 3/4"	64 1/2"	7'11" ÷ 10'
LWF 30/54	75 3/4"	64 1/2"	7'11" ÷ 10'
LWS-M 27/47	67 1/2"	57 1/2"	7'2" ÷ 8'10"
LWS-P 22/47	67 1/2"	57 1/2"	7'2" ÷ 8'10"
LWS-P 25/47	67 1/2"	57 1/2"	7'2" ÷ 8'10"
LWS-P 22/54	75 1/2"	64 1/2"	7'2" ÷ 10'
LWS-P 25/54	75 1/2"	64 1/2"	7'2" ÷ 10'
LWS-P 30/54	75 1/2"	64 1/2"	7'2" ÷ 10'
LWS-P 22/54	74"	54 3/8"	10' ÷ 10'8"
LWS-P 25/54	74"	54 3/8"	10' ÷ 10'8"
LWS-P 30/54	74"	54 3/8"	10' ÷ 10'8"
LWM/LWM-P 22/47	69 3/16"	60"	7'2" ÷ 8'10"
LWM/LWM-P 25/47	69 3/16"	60"	7'2" ÷ 8'10"
LWM/LWM-P 22/54	74 3/4"	64 1/2"	7'2" ÷ 10'
LWM/LWM-P 25/54	74 3/4"	64 1/2"	7'2" ÷ 10'
LWM/LWM-P 30/54	74 3/4"	64 1/2"	7'2" ÷ 10'
LSF 22/47	72 3/4"	47 3/16"	9'2 1/2" ÷ 9'10"
LSF 25/47	72 3/4"	47 3/16"	9'2 1/2" ÷ 9'10"
LST 22/31	63"	56"	8'6 1/2" ÷ 9'6"
LST 22/47	63"	56"	8'6 1/2" ÷ 9'6"
LST 25/47	67"	60"	8'6 1/2" ÷ 9'6"
OLN/OLN-P 22/47	66 1/2"	57 3/16"	7'2" ÷ 8'10"
OLN/OLN-P 25/47	66 1/2"	57 3/16"	7'2" ÷ 8'10"
OLN/OLN-P 22/54	74"	64"	7'11" ÷ 10'
OLN/OLN-P 25/54	74"	64"	7'11" ÷ 10'
OLN/OLN-P 30/54	74"	64"	7'11" ÷ 10'
OWM/OWM-P 22/47	70 3/16"	57 1/2"	6'2" ÷ 8'10"
OWM/OWM-P 25/47	70 3/16"	57 1/2"	6'2" ÷ 8'10"
OWM/OWM-P 22/54	72 3/4"	64"	7'1" ÷ 10'
OWM/OWM-P 25/54	72 3/4"	64"	7'1" ÷ 10'
OWM/OWM-P 30/54	72 3/4"	64"	7'1" ÷ 10'

Table 1

V. CUTTING A HOLE IN THE CEILING

Before you begin:

find a spot which is:

- free from any obstacles in the attic area
- free from obstacles in the ceiling
- big enough to carry out the installation
- big enough to use a step ladder

STEP 1

Prepare the work area. Remove the furniture and cover the floor with a drop cloth. Remove children and pets to a safe distant area.

STEP 2

Put on the safety goggles, dust mask and gloves. These will protect your eyes and lungs.

STEP 3

Using a hammer and a chisel make an initial hole near the center of your chosen location (Figure 5).

STEP 4

Enlarge the initial hole with a hand saw until you can see the joist (Figure 6)

STEP 5

Trace the cutting lines on the ceiling for the installation opening. Make sure that one of the traced lines is parallel to the ceiling joist (Figure 7, table 2).

Note:

Having one edge of the opening parallel to the ceiling joist will allow to use it as part of the frame which will be needed for installation.

STEP 6

Cut out and remove remaining part of the ceiling according to traced lines (rectangle) while observing:

- not to cut any joists, only the ceiling board
- remove the ceiling board by small pieces, because the ceiling materials can be very heavy.

STEP 7

If there are joists in the cut out opening proceed to section 6 "Cutting the ceiling joists".

If there are no joists along or across the opening go to section 7 "Framing the installation opening" Page 7-9.

WARNING!

Do not cut, file nor nail anything to the ceiling until you are sure that the chosen space for installation is free from dangers and other obstacles. Contact with electric wires can be deadly.



Fig.5. Make an initial hole.

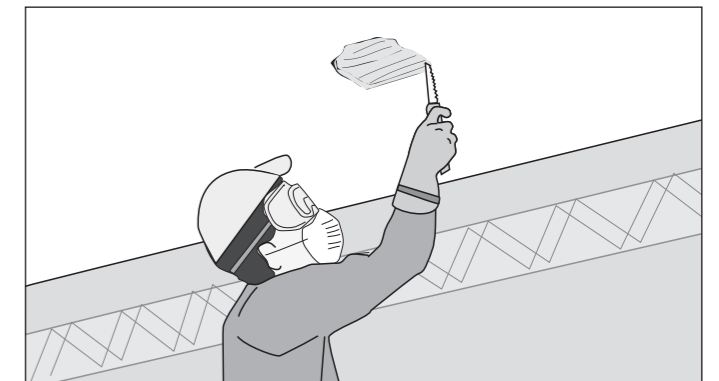

Fig.6. Enlarge the initial hole so that you can see the joist.



Fig.7. Draw a rectangle the size of the ceiling opening.

MODEL	Ceiling opening size	MODEL	Ceiling opening size
LWF 22/47	22 1/2" ÷ 47"	LSF 22/47	22 1/2" ÷ 47"
LWF 25/47	25" ÷ 47"	LSF 25/47	25" ÷ 47"
LWF 22/54	22 1/2" ÷ 54"	LST 22/31	22 1/2" ÷ 31"
LWF 25/54	25" ÷ 54"	LST 22/47	22 1/2" ÷ 47"
LWF 30/54	30" ÷ 54"	LST 25/47	25" ÷ 47"
LWS-M 27/47	27 1/2" ÷ 47"	OLN/OLN-P 22/47	22 1/2" ÷ 47"
LWS-P 22/47	22 1/2" ÷ 47"	OLN/OLN-P 25/47	25" ÷ 47"
LWS-P 25/47	25" ÷ 47"	OLN/OLN-P 22/54	22 1/2" ÷ 54"
LWS-P 22/54	22 1/2" ÷ 54"	OLN/OLN-P 25/54	25" ÷ 54"
LWS-P 25/54	25" ÷ 54"	OLN/OLN-P 30/54	30" ÷ 54"
LWS-P 30/54	30" ÷ 54"	OWM/OWM-P 22/47	22 1/2" ÷ 47"
LWM/LWM-P 22/47	22 1/2" ÷ 47"	OWM/OWM-P 25/47	25" ÷ 47"
LWM/LWM-P 25/47	25" ÷ 47"	OWM/OWM-P 22/54	22 1/2" ÷ 54"
LWM/LWM-P 22/54	22 1/2" ÷ 54"	OWM/OWM-P 25/54	25" ÷ 54"
LWM/LWM-P 25/54	25" ÷ 54"	OWM/OWM-P 30/54	30" ÷ 54"
LWM/LWM-P 30/54	30" ÷ 54"		

Table 2

VI. CUTTING THE CEILING JOISTS

Before you begin:

you should now have the cut out hole in the appropriate spot.

STEP 1

If the room has a ceiling in which you made the opening proceed to step 2.

If there is no ceiling in place mark the joists according to instruction A or B, below.

A - If the chosen location is parallel to the ceiling joists, mark the length of the opening on the top surface of the joist as shown on Figure 8. Do not cut the joist as marked.

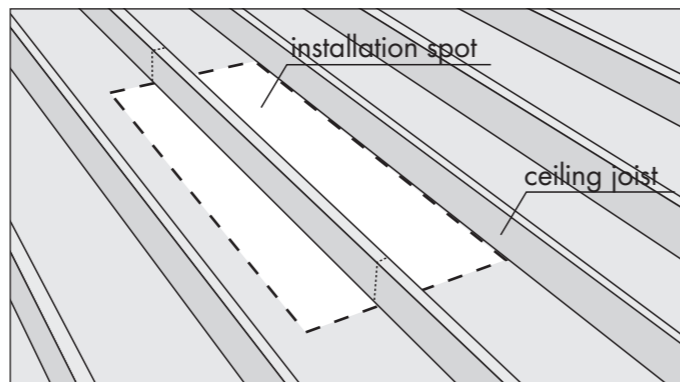

Fig.8. Dotted line indicates your chosen location parallel to the joist.

B - If the chosen location is perpendicular to the ceiling joists, mark the width of the opening on the top surface of the joist as shown on Figure 9. Do not cut the joist as marked.

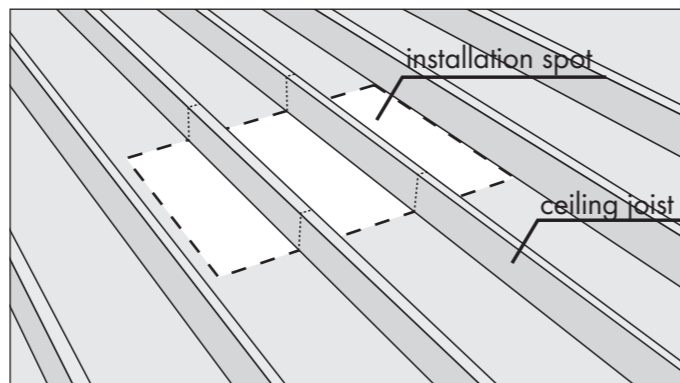

Fig.9. Dotted line indicates your chosen location perpendicular to the joist.

STEP 2.

Cut 2 pieces of board similar to the size of the ceiling joist, long enough to nail them to the ceiling joists on both ends of the opening (Figure 10). These boards will provide support to joists which will be cut out.

STEP 3

Position these boards approximately 2 ft from the opening edge (Figure 10).

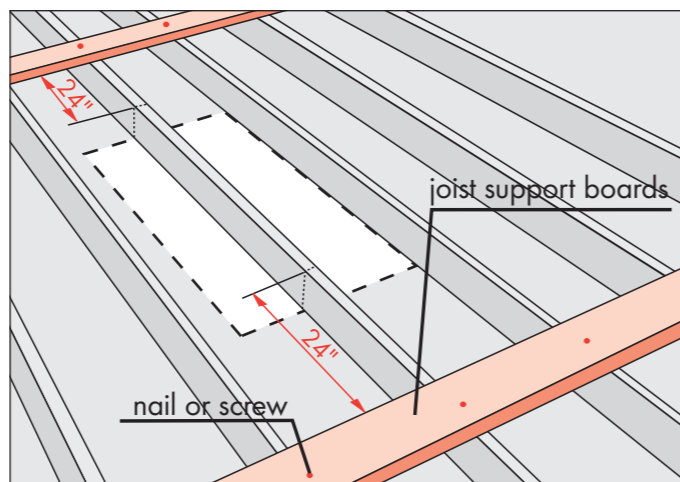

Fig.10. Dotted line indicates your chosen location.

Note

The 2 ft space is required to nail the frame.

STEP 4

Next decide where you will cut the joist see Figure 11. The cutting line should be away from the actual opening twice the thickness of the frame (usually 3 inches). This will allow to install double headers at both ends of the joist (Figure 17, Page 8).

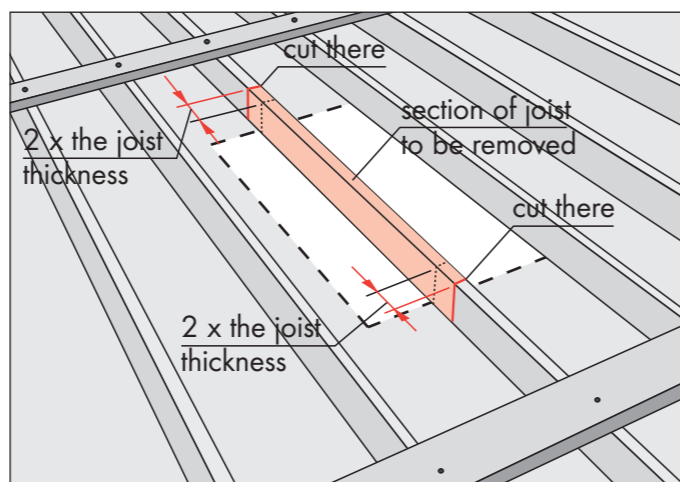

Fig.11. Dotted line indicates your chosen location.

Note

In older homes the thickness of the joist might be greater than what is currently sold in lumber yards. In such case the cutting line should be marked at twice the thicknesses of the material which you will use to build the frame not the joist.

STEP 5

Cut the joist carefully, watching not to cut the ceiling board and making sure that the cut out joist is even and vertical (square).

VII. FRAMING THE INSTALLATION OPENING

Before you begin:

the distance between the joists should be the same as the width of installation opening. All cut joists must be attached to the joists that have not been cut.

WARNING!

For your own safety mind all dangerous elements above your head. Do not sit on the ceiling - it is not designed to carry load. Only joists will withstand load. In order to make a working area place several boards across the ceiling joists.

Installing the headers

If none of the joists were cut proceed to section "single header".

If one or more joists were cut proceed to section "double headers" on page 8.

Single headers

STEP 1

Measure the distance between the ceiling joists. The measurement should be done perpendicular to the joist (Figure 12).

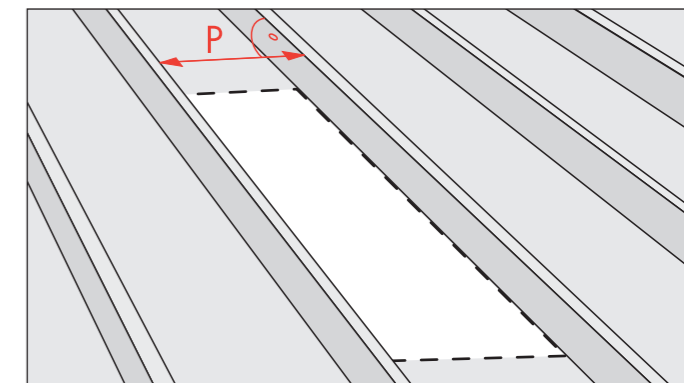

Fig.12. P Distance between the ceiling joists.

STEP 2

Cut 2 boards for headers to the measured length. Use timber material similar in size to the joists.

STEP 3

Position the header at one end of the installation opening (Figure 13). The header must tightly fit between the joists. If needed use a hammer to position the header.

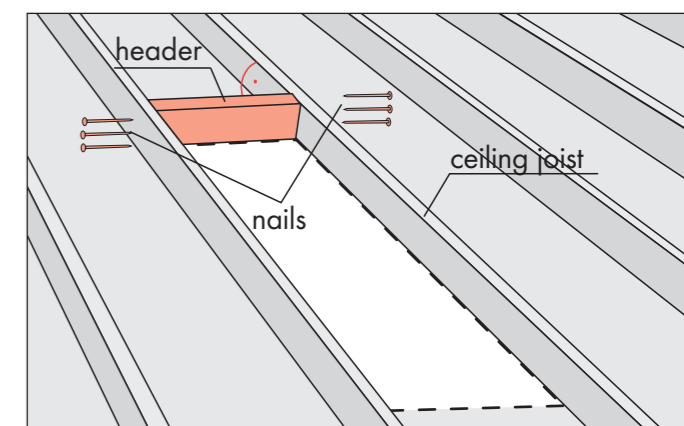

Fig.13. Nail the header at both ends.

Step 4

Align the header at 90° angle to the joists and drive 3 nails (16D) at each end.

STEP 5

Position the second header 31", 47" or 54" apart from the first one and repeat step 4 (Figure 14). The distance between the headers depends on ladder model.

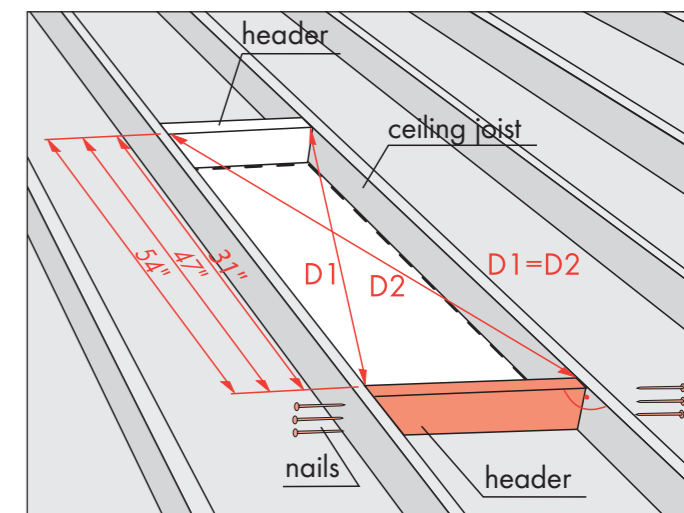

Fig.14.

STEP 6

The frame must have four sides where the headers are two of them. If the ceiling joists are positioned as the other two sides check the angles by measuring the diagonals. Both measured dimensions should be within 1/8" to consider them equal.

If the ceiling joists do not make the other two sides of the frame, you should install one or two wooden elements in order to make the frame in the ceiling opening. Proceed to section "installation of stringers".

Double headers

STEP 1

Measure the length of the header "P" between uncut joists (Figure 15). The measurement should be done perpendicular to the joists.

STEP 2

Cut to size 4 headers. For that purpose use timber similar in size to existing joists.

STEP 3

Position one header at the end of the cut out joist (Figure 16). It must fit tightly between the uncut joists. If needed use a hammer to set the header in the appropriate place.

STEP 4

Square the header to one joist and drive 3 nails (16d) on both ends and to the cut joist (Figure 16).

STEP 5

Position the second header in front of the first one and nail it (Figure 17).

STEP 6

Repeat steps 3-5 in order to install headers at the other side of the ceiling opening.

STEP 7

In order to install other elements of the frame proceed to section "installation of stringers".

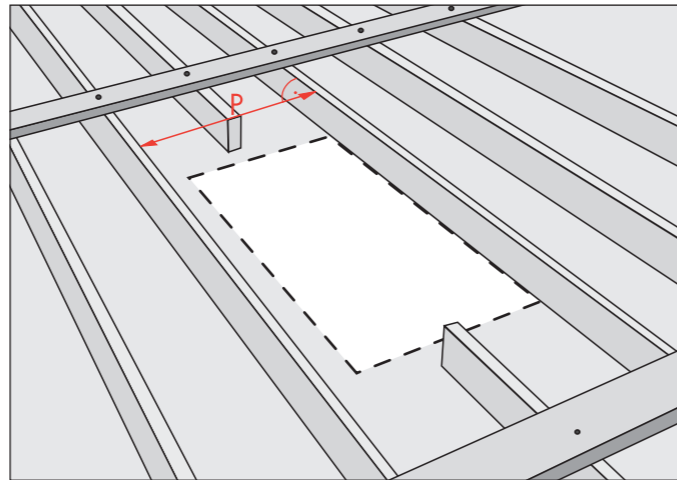

Fig.15. P- Distance between the ceiling joists.

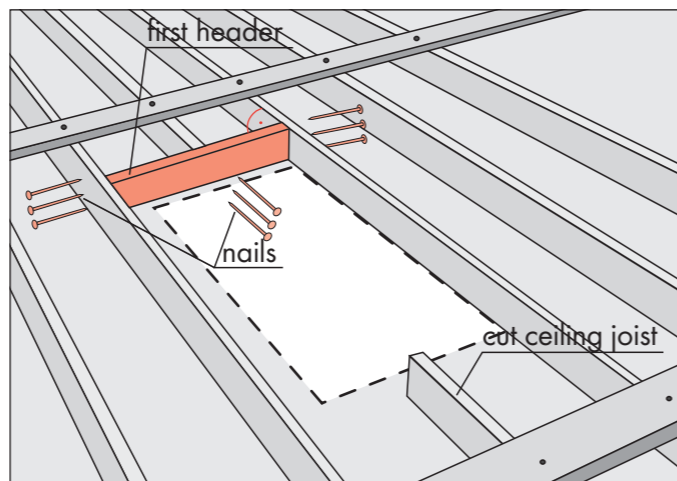

Fig.16.

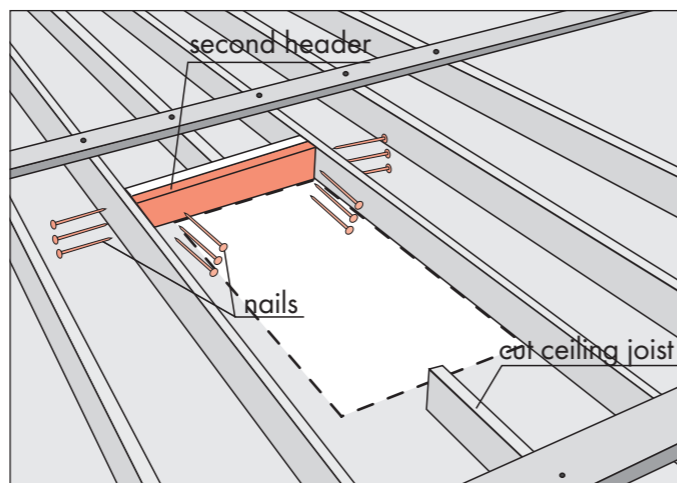

Fig.17.

Installation of stringers

STEP 1

Measure the length of the stringer "W" between the cross-beams (Figure 18). The measurement should be perpendicular to the headers.

STEP 2

Cut the stringer to size. Use timber similar in size to the existing ceiling joists.

STEP 3

If the joists do not make up the other two sides of the frame, you need to install one more stringer of the same length as before. On Figure 18 only one stringer is needed because the ceiling joist makes up one side of the frame.

STEP 4

Position the stringer (or stringers) along the unframed side if the ceiling opening (Figure 19). The inside dimensions of the frame should be equal to the ceiling opening (see Table 2 on Page 5).

STEP 5

In order to install stringers to the headers you should use nails long enough to go through both cross-beams and enter the stringer at least 1". In most cases it should be 20d nail 4" long. Square the stringer and drive 3 nails at each end through the double header. Both measured dimensions should be within 1/8" to consider them equal.

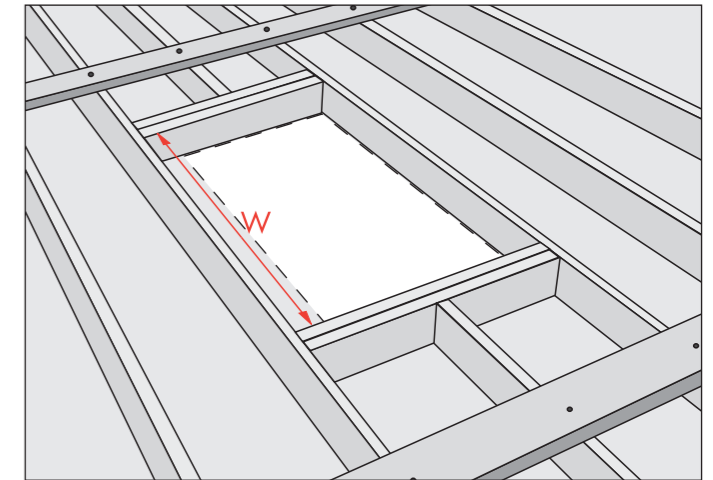

Fig.18. W- Distance between the ceiling joists.

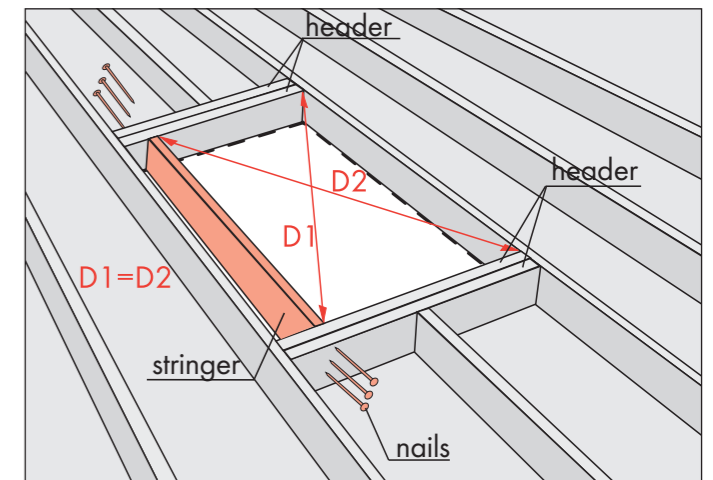

Fig.19.

