



GROUND FORCE TM



Electric-Powered Go Kart

Read and understand this entire manual before driving.
(Specifications subject to change without notice.)

Save this manual with your original sales receipt.

For service bulletins and answers to frequently asked questions, go to: www.razor.com.

For your records, write serial number (located on motor bracket) _____

O w n e r ' s M a n u a l

Item number: 300001-SL

Table of Contents

1. Important Information	2
2. Key Parts of the Ground Force	4
3. Preparing for First-Time Use	
3A. Un-box	5
3B. Steering wheel	5
3C. Attach the seat	6
3D. Attach the seat with the seat chain	7
3E. The brake	7
3F. Charging prior to use	8
3G. Circuit breaker	9
4. Safety Check Before Riding	9
5. Maintenance and Repairs	9
6. Safety	14
7. Illustrated Parts Breakdown	16
8. Limited Warranty and Owner Registration	18

 **NOTE:** This manual contains many “Warnings” and “Cautions” concerning the consequences of failing to maintain, inspect or properly use your Ground Force. Because any incident can result in serious injury or even death, we do not repeat the warning of possible serious injury or death each time such a warning is mentioned.

AN IMPORTANT MESSAGE TO RIDERS AND PARENTS: READ THIS ENTIRE MANUAL BEFORE OPERATING OR ALLOWING USE OF THE Ground Force, AND KEEP THIS MANUAL AVAILABLE FOR FUTURE REFERENCE. This manual contains important safety information. For safety, it is your responsibility to review this information and make sure that all riders understand all warnings, cautions, instructions and safety topics and assure that young riders are capable and able to safely and responsibly use this product. Razor USA recommends that you periodically review and reinforce the information in this manual with younger riders, and you are required to inspect and maintain your child’s vehicle to insure their safety.

The recommended rider age is only an estimate, and can always be effected based upon a particular rider’s size, weight or skills. If the rider is unable to fit comfortably on the Ground Force, don’t attempt to ride it.

Keep this product away from small children and always understand that this product is intended for use only by persons who are, at a minimum, completely comfortable and competent while operating the vehicle.

 **GENERAL WARNING:** Driving the Ground Force can be a hazardous activity. Electric vehicles can, and are intended to, move and it is therefore possible to get into dangerous situations and/or lose control and/or fall off. If such things occur you can be seriously injured or die. LIKE ANY OTHER MOVING PRODUCT, USING THE GROUND FORCE CAN BE A DANGEROUS ACTIVITY AND MAY RESULT IN INJURY OR DEATH EVEN WHEN USED WITH SAFETY EQUIPMENT AND OTHER PRECAUTIONS. USE AT YOUR OWN RISK AND USE COMMON SENSE.

- Always check and obey any local laws or regulations which may affect the locations where the Ground Force may be used on public property. The Ground Force is meant to be used only in controlled environments free of potential traffic hazards, and not on public streets or sidewalks. Do not try to ride your Ground Force on public streets or in any areas where pedestrian or vehicle traffic may present a risk of collision or injury to yourself or others. Watch out for potential obstacles including pedestrians, skaters, skateboards, scooters, bikes, children or animals who may enter your path, and respect the rights and property of others.
- Do not ride the Ground Force in wet weather and never immerse the Ground Force in water, as the electrical and drive components of the Ground Force could be damaged by water or create other possibly unsafe conditions.
- The Ground Force is designed to perform best outdoors on solid flat, clean and dry surfaces. Wet, slick or uneven and rough surfaces may impair traction and contribute to possible accidents. Use only on flat, dry, level ground without loose debris, such as rocks or gravel. Do not drive the Ground Force in mud, ice, puddles or water. Avoid excessive speeds that can be associated with downhill rides. Never risk damaging indoor surfaces such as carpet or flooring by use of a Ground Force indoors.
- Do not ride at night or in impaired visibility conditions.
- Always wear proper protective equipment, such as an approved safety helmet, elbow pads and kneepads. A helmet may be legally required by local law or regulation in your area, and should always be worn when driving a Ground Force. Always wear shoes, never drive barefooted or in sandals, and keep shoelaces tied and out of the way of the wheels, motor and drive system.
- The electric motor in your Ground Force can become hot when in use. Do not touch the motor and handle the Ground Force carefully.
- Do not exceed the weight limit of 120 pounds (see warning on back page).
- Do not attempt or do stunts or tricks on your Ground Force. The Ground Force is not made to withstand abuse from misuse such as jumping, curb grinding or any other type of stunts.
- The charger supplied with the Ground force should be regularly examined for damage to the cord, plug, enclosure, and other parts and in the event of such damage, the kart must be not charged until it has been repaired or replaced.
- Use only with the recommended charger.
- The charger is not a toy.
- If wiping down and cleaning your Ground Force with liquid, always disconnect from the charger before cleaning.
- Refer to the chapter on Safety for additional warnings.

FAILURE TO USE COMMON SENSE AND HEED THE ABOVE WARNINGS FURTHER INCREASES RISK OF SERIOUS INJURY. USE AT YOUR OWN RISK AND WITH APPROPRIATE AND SERIOUS ATTENTION TO SAFE OPERATION. USE CAUTION.

2. Key parts of the Ground Force



 **NOTE:** Do not activate the speed control on the steering wheel unless you are in a safe, outdoor environment. Use this product only in areas free of potential traffic hazards and not on public streets or sidewalks.

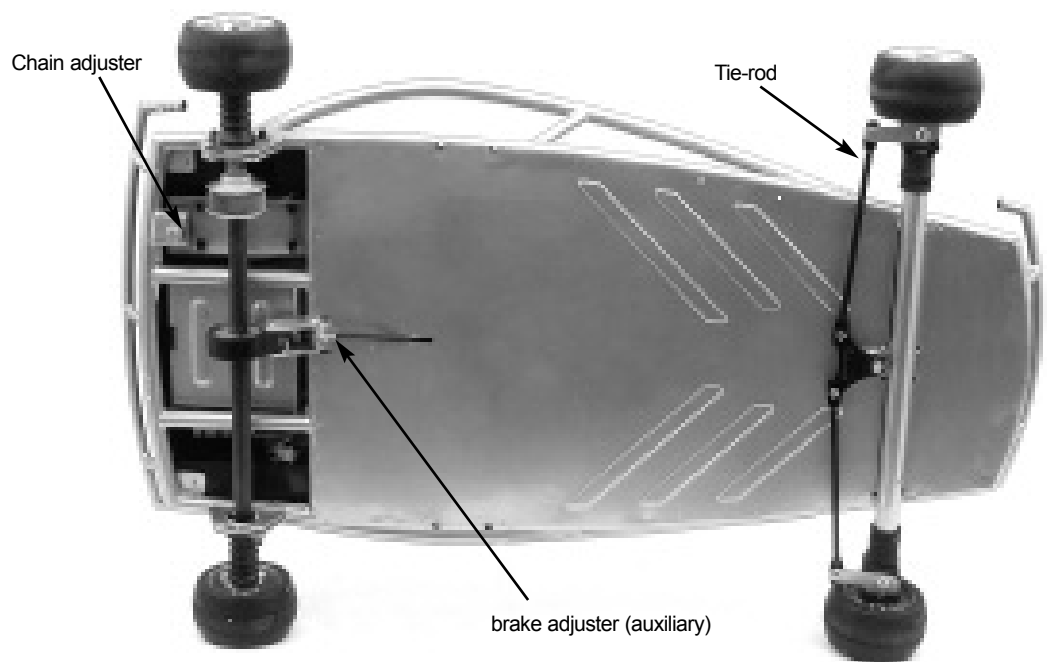

 **WARNING:** REGARDING USE OF NON-RAZOR PRODUCTS WITH YOUR RAZOR Ground Force. The Ground Force has been built to certain Razor design specifications. The original equipment supplied at the time of sale were selected on the basis of their compatibility with the frame, fork and all other parts. Certain after-market products may or may not be compatible. Consult your retailer or call Razor prior to modifying or replacing any component with a non-factory specified product.

 **WARNING:** CHECK LOCAL LAWS REGARDING USE. Check local laws and

regulations to see where and how you may use your Razor Ground Force legally. In many states and local areas, riders are required BY LAW to wear a helmet. Check local laws and regulations regarding laws governing helmet use, age and vehicle operation in your area.

The transformer/charger supplied with the electric scooter should be regularly examined for damage to the cord, plug, enclosure and other parts, and, in the event of such damage, the scooter must not be charged until it has been repaired or replaced.

Use ONLY with the recommended charger. The charger is not a toy. If cleaning your electric scooter with liquid, always disconnect from the charger before cleaning.

Battery Care and Disposal

 **WARNING:** If a battery leak develops, avoid contact with the leaking acid and place the damaged battery in a plastic bag. Refer to the following disposal instructions.

If acid comes into contact with skin or eyes, flush with cool water for at least 15 minutes and contact a physician.

Do not store the battery in temperatures above 75° or below -10° F.

 **DISPOSAL:** Your Razor product uses sealed lead-acid batteries. They must be recycled or disposed of in an environmentally sound manner.

Do not disposed of a lead-acid battery in a fire. The battery may explode or leak.

Do not dispose of a lead-acid battery in your regular household trash. The incineration, landfilling or mixing of sealed lead-acid batteries with household trash is prohibited by law in most areas.

Return exhausted batteries to a federal or state approved lead-acid battery recycler or a local seller of automotive batteries. If you live in the State of Florida or Minnesota, it is prohibited by law for anyone to throw away lead-acid batteries in the municipal waste stream.

TOOLS REQUIRED FOR ASSEMBLY

- 5mm hex key wrenches.
- 10mm box wrench (spanner)
- *Razor recommends assembly by an adult with experience in mechanics. Some tools may be supplied, however we recommend the use of mechanic's grade tools. Use the supplied tools only as a last resort.*

 **WARNING:** Failing to properly adjust and tighten the screws, nuts and bolts that affix the steering wheel and seat can cause you to lose control and crash.

Estimated assembly and adjustment time: allow up to 45 minutes, not including initial charge time. Allow up to 8 hours for initial charge (see page 8 and 9 for charging information)

3. Preparing for First-Time Use

3A. Un-box. Remove contents from box. Remove the foam separators that protect the various components from damage during shipping. Inspect the contents of the box for scratches in the paint, dents or kinked cables that may have occurred during shipping. The Ground Force was 95 percent assembled and packed at the factory to prevent shipping damage and there should not be any problems, even if the box has a few scars or dents. But if there are, contact Razor USA, toll free, at (866) 467-2967 to resolve any problems.

3B. Steering wheel. Remove the bolt and washers at the end of the steering axle as shown in Figure 2a. Untangle the wires and orient as shown in Figure 2b. Insert steering axle into steering column as shown in Figures 2b and 2c.

Carefully turn the Ground Force on it's side. We recommended that you have someone hold the Ground Force up or, alternately, you can lean it against a wall for the installation of the tie-rod to the steering axle.

 **WARNING:** Flipping the Ground Force upside down is not recommended as it could damage the control wires from the steering wheel.

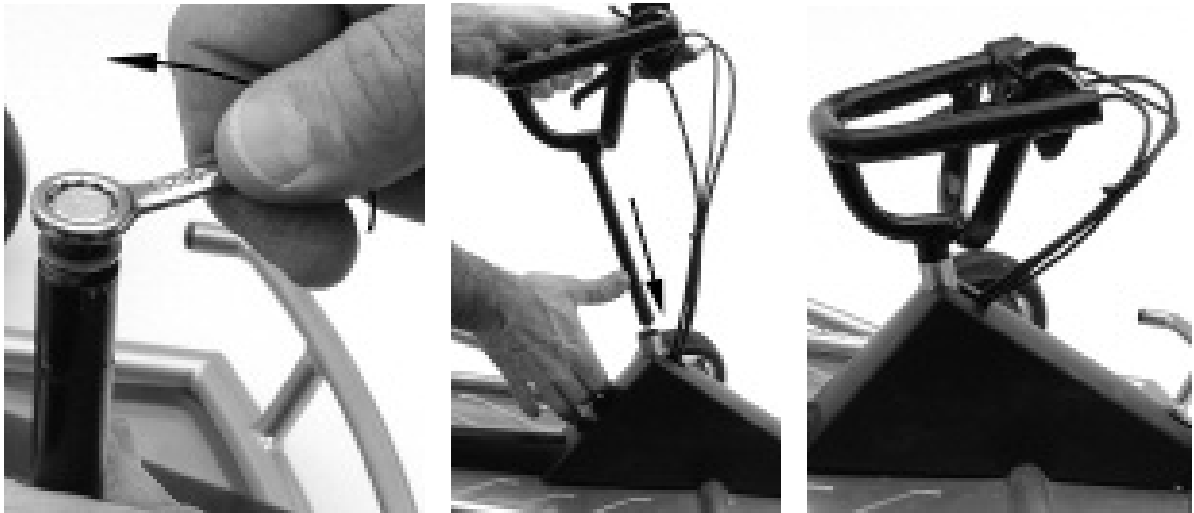

*Figures 2a, 2b and 2c.
Positioning the steering wheel for attachment to tie-rods.*

Tighten securely. Position the tie-rod control arm onto the steering axle as shown in Figure 3a and install the washers and fixing bolt. Using a 10mm wrench, tighten securely.

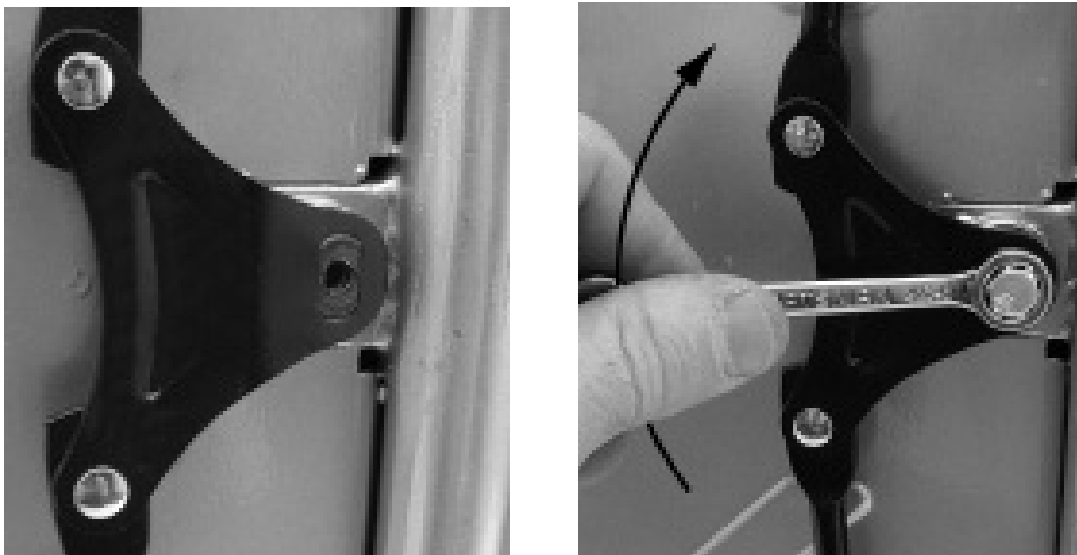

Figure 3a and 3b. Tighten the tie-rod control arm using a 5mm hex key wrench.

⚠ WARNING: Failure to use the washer and lock washer or failure to properly tighten the steering wheel may cause you to lose control and crash.

3C. Attach the seat without seat belt assembly. Locate the four (4) long seat attachment screw and spacer washers in the parts bag. Position the seat over the frame and align it with the holes in the frame. Insert the screws as shown in Figure 4a, using the spacer washer as indicated by the arrow in Figure 4a. Insert all four screws and washers and tighten securely using two Allen key wrenches as shown in Figure 4b.

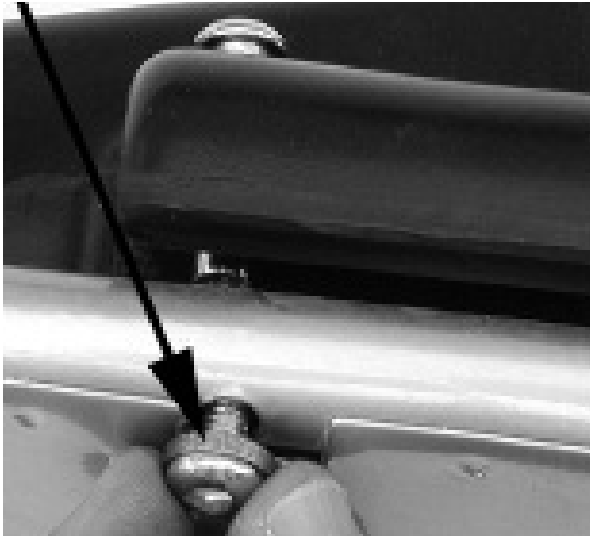



Figure 4a and 4b.

3D. Optional attaching the seat with seat belt assembly. Locate the four (4) long seat attachment screws and seat-belt assembly in the parts bag. Position the seat over the frame and align it with the holes in the frame. Position the seat-belt anchors with the lap/shoulder assembly on the left side and the receiver latch on right side. Insert the screws as shown in Figure 5a and tighten. Install the shoulder belt anchor to the back of the seat as shown in Figure 5b using the supplied screw, tighten securely.



Figure 5a and 5b.

 **WARNING:** The seat belt arrangement supplied with the Ground Force is for “play” use only. It is not an ASTM-approved safety belt system and is not intended to function as an approved lap/shoulder/seat restraining device. The seat belt system is not required for normal use. Install and use at your own risk.

 **NOTE:** Although we make every effort to keep our manual up-to-date, if your Ground Force does not look exactly as shown here, then we may have made improvements since this document was printed. Check out the Razor website: www.razor.com for technical updates on the latest service and adjustment procedures.

3E. The brake. The Ground Force is fitted with a hand-operated brake. To use the brake, squeeze the brake lever to increase the pressure on the brake until so you come to a smooth and controlled stop. The brake lever is fitted with a cable adjuster to compensate for cable stretch and/or to fine tune the lever movement to brake engagement. To adjust the play, thread the adjuster in or out (arrows, Figure 6a) 1/4 to 1/2 turn until the desired brake adjustment is attained.

If the adjuster at the lever is threaded outward and the brake still has too much slack, use the auxiliary adjuster at the rear brake for additional adjustment (shown in Figure 6b). When properly adjusted, the brake lever will have approximately 3mm of free play before the brake engages



Figures 6a

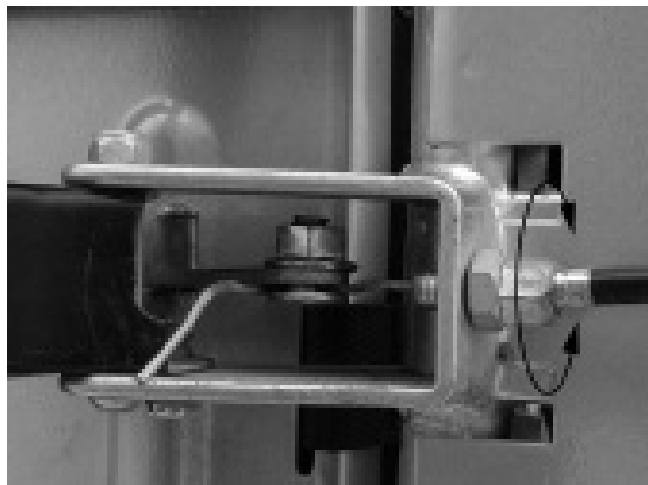



Figure 6b.

 **WARNING:** Practice in an open area free from obstacles until you are familiar with the brake function. Avoid skidding to a stop as this can cause you to lose control as well as cause damage the rear tires. **DO NOT RUN OVER ANY OBJECT AS IT COULD DAMAGE THE BRAKE OR DRIVETRAIN.**

3F. Charging the battery prior to use. Your Ground Force may not have a fully charged battery at the time of purchase. Therefore it is a good idea to charge the battery prior to use. The charging input, on/off switch and overload breaker are located on top of the battery/motor cover.

Plug in the charger as shown in Figure 7a and connect to a household wall outlet.



Figure 7a



Figure 7b.

The charger has a small window with a LED to indicate the charge status (Figure 7b).

Refer to the illustration on the charger unit for the actual “charging” and “charged” status indications for your model charger.

The initial charge may take from a few minutes to up to 4 hours or more depending on the level of depletion.

If your charger does not look exactly like the one in Figure 7b, your unit has been supplied with an alternative charger. The specifications and charging procedure would not change, however.

⚠ NOTE: The initial charge could take up to 8 hours. Be sure to fully charge prior to using your Ground Force for the first time.

3G. Circuit breaker. The circuit breaker (next to charger input port in Figure 7a) will automatically shut off the power to the motor in the event an overload condition is placed on the motor. An excessive overload, such as too heavy a driver or too steep a hill, could cause the motor to overheat. If the Ground Force suddenly stops running, wait a few seconds and then push the breaker to reset the circuit. Avoid whatever conditions caused the breaker to trip and avoid repeatedly tripping the breaker.

4. Safety Check Before Driving

4A. Loose parts. There should not be any unusual rattles or sounds from loose parts or broken components. If you are not sure, ask an experienced mechanic to check.

4B. Brake. Check the brake for proper function. When you squeeze the lever, the brake should provide positive braking action.

4C. Frame and steering wheel. Check for cracks or broken connections. Although broken frames are rare, it is possible for an aggressive driver to bash into a curb or wall and wreck and bend or break a frame. Get in the habit of inspecting yours regularly.

 **CAUTION:** This product moves when used. Exercise caution and common sense at all times. DO NOT RUN OVER ANY OBJECT AS IT COULD DAMAGE THE BRAKE OR DRIVETRAIN.

5. Maintenance and Repairs

 **NOTE:** Tires and drive system are subject to normal wear and tear. It is the responsibility of the user to periodically inspect the tires for excess wear and adjust and replace drive train components as required.

Check out the Razor website: www.razor.com for any updates on the latest maintenance, repair and trouble-shooting procedures.

5A. Adjusting the DRIVE CHAIN

 **NOTE:** Turn power switch off before maintenance procedures.

 **WARNING:** To avoid a pinch or injury, keep fingers away from moving sprockets and chain.

If the drive system makes loud noises, slips or makes grinding sounds during the power-on condition, this indicates the drive chain is probably making the noise. This can be caused by the chain being adjusted too tight during assembly or coming loose from normal wear-and-tear.

 **NOTE About chain adjustment:** The chain should be **not** be under tension nor floppy loose. There should be about 3/8-inch (10mm) of slack (refer to figure 8c). BE CAREFUL NOT TO ADJUST TOO TIGHT. The tensioning system can easily impart too much tension and snap the chain or bend the motor output shaft. Turn the adjusting bolt by hand 1/8 to 1/4 turn or less, at a time and recheck the adjustment each time.

If the chain is too tight, or too loose (skips or comes off), then it may need to be readjusted. To adjust the chain:

5A1. Referring to Figure 8a, loosen the chain jack-screw locknut (B) and tighten or loosen the adjusting bolt (A) to tighten or loosen the chain as needed.

Referring to Figure 8b, the chain-drive system consists of the drive-shaft sprocket (A), the roller chain (B), the adjusting bolt (C and B in 8a), and the motor shaft sprocket (D).

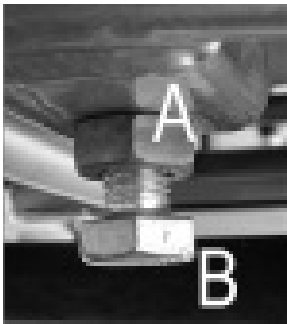

Figure 8a

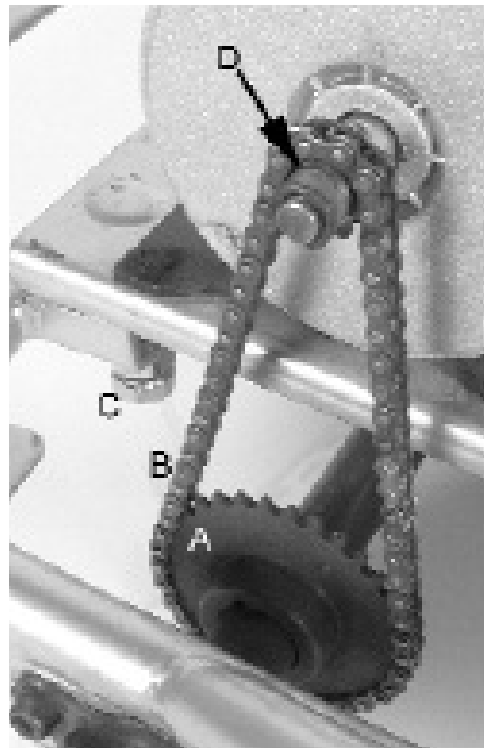

Figure 8b

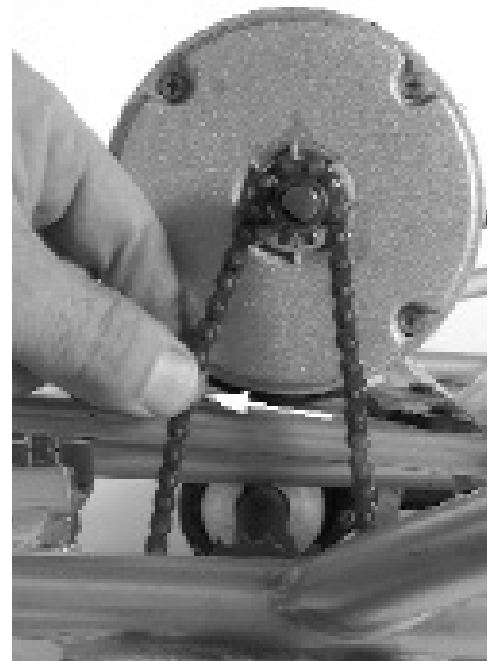

Figure 8c

⚠ NOTE: the motor cover does not need to be removed for this adjustment procedure. The chain adjustment can be checked tipping the Ground Force on it's side and reaching under the cover (with power switch OFF). However, for the first time you make this adjustment we recommend you remove the cover to see exactly what is happening.

5A2. Once the adjustment is good, while hold the adjusting screw, **retighten the locknut securely.** Test run the Ground Force. Re-adjust as needed.

If the locknut is not tightned properly, the adjustment will vibrate loose from normal driving.

⚠ NOTE: Proper alignment of the chain must be maintained. If the chain is adjusted properly, but is noisy or rough running, check alignment of the sprockets. The drive-shaft sprocket can be adjust slightly from side-to-side by loosening the set screw. Note that a key maintains the drive position to the shaft.

5B. Wheel removal Procedure.

Occasionally the wheels need to be replaced when worn out. The front and rear wheels are identical and can be interchanged. The only difference is how the wheels attach. The rear wheels are keyed to the rear axle, while the front wheels have bearings (608ZZ = standard skateboard bearings).

5B1. To remove a wheel, loosen and remove the self-locking nut (13mm socket or wrench required for the front wheels; 17mm socket or wrench required for the rear wheels). Tap the wheel to remove.

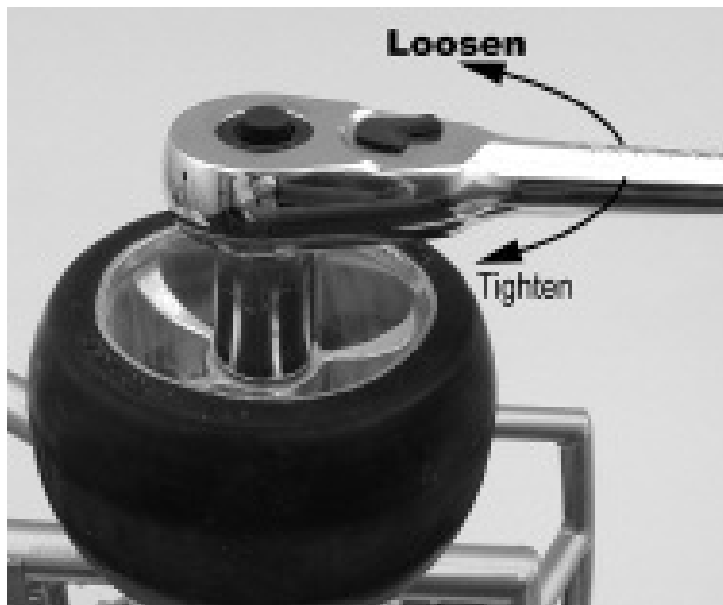



Figure 9.

5B2. To replace a front wheel, make sure the bearings are seated and the center spacer is installed. Position the wheel so the Razor logo is toward the outside. Install the washer and tighten the self-locking nut securely. Refer to Figure 10 for assembly detail.

 **NOTE:** The Razor logo on the rubber tread must face out.

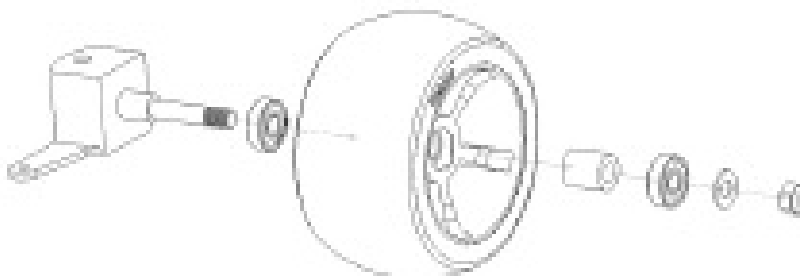



Figure 10.

5B3. To replace a rear wheel, make sure the key is properly seated in the rear axle and

aligned with the key way in the wheel (Figure 11). Tighten the self-locking nut securely.

 **NOTE:** The Razor logo on the tread must face out.

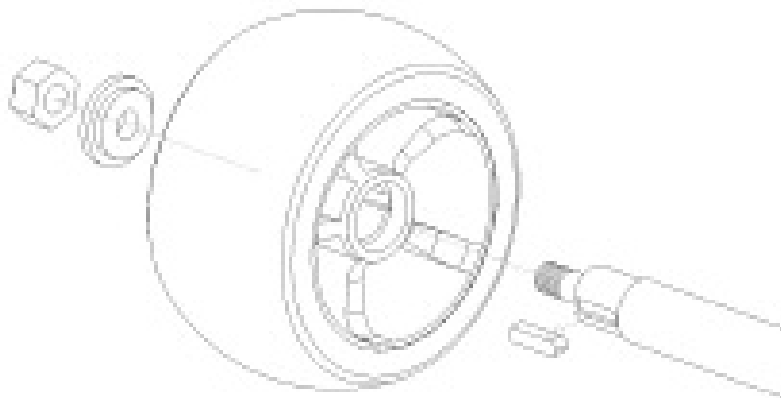



Figure 11.

5C. Replacing the Chain

 **NOTE:** Initial production versions of the Ground Force utilized a chain drive. Subsequent production was switched to a roller-chain drive system. Due to publication deadlines, the following photos show the chain configuration. In either case, the procedure to remove the axle is the same.

Occasionally the chain needs to be replaced when worn out.

Tools required for rear wheel and axle removal: (1) 17mm open end or socket wrenches, (1) 5mm Allen key, (1) 2mm Allen key, (1) rubber mallet.

 **NOTE:** The exact procedure for chain replacement may vary depending on how your Ground Force is configured. The following procedure is based on the design at time of publication of this Owner's Manual. If your Ground Control does not look exactly like this, please check the Razor website (www.razor.com) for updates.

5C1. Remove the seat and motor cover. Loosen the chain adjustment jackscrew as described in 5C2. Loosen and remove the axle nut on the right side rear wheel (Figure 12a).

5C3. Loosen and remove the axle guard (Figure 12b). Remove the spacer tube and any shims or rings that the factory may have used to fine-tune the fit.

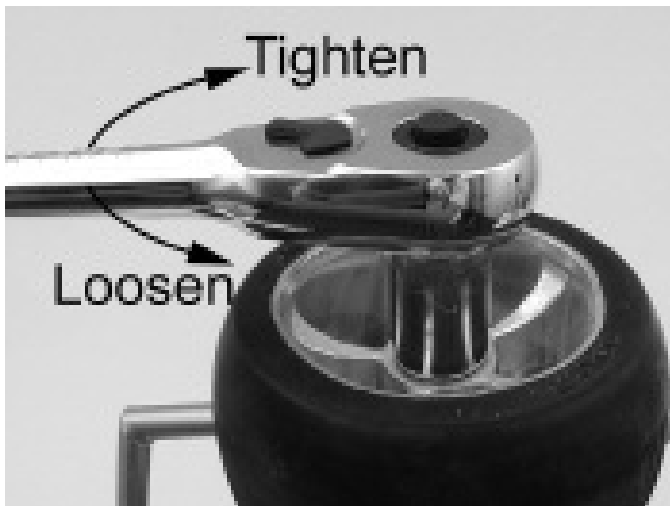

Figure 12a



Figure 12b

4C4. Remove the brake guard and, using the small Allen key, loosen setscrew to release the brake drum. This may or may not require the loosening of the brake cable to gain access to the fixing screw. Loosen the drive pulley in the same manner. Slide the brake drum toward the drive pulley.

5C5. Lightly tap the end of the axle with a rubber mallet. DO NOT USE A HAMMER as this will damage the thread. The axle will slide through the bearing hanger on the frame. The brake drum and pulley must be slid along the axle as your tapping progresses.

5C6. When the axle end is clear of the bearing hanger, remove and replace the chain (or belt) as shown in Figure 13.



Figure 13. Belt shown. For chain-drive use the same procedure.

5C7. Reverse procedure to reassemble and tension the belt as described in 4A.

6. Safety

 **NOTE:** The following RECOMMENDATIONS ARE excerpted from: ASTM F1928-98, “Standard safety Guide for Consumer recreational use of Fun-carts”

Go kart shall not be operated with any modifications to the kart or it’s components.

Go Karts shall not be operated to perform racing, stunt riding, jumps, spin-outs, donuts or other maneuvers which may cause loss of control, or may cause uncontrolled operator or kart actions or reactions, as such activities are likely to result in possible injury to the operator or bystanders or both.

Go Kart shall not be operated unless the rider is seated in the proper position for vehicle operation with the rider’s hands on the steering wheel, the brake fully engaged and the safety beat fastened.

No person shall allow hands, feet, hair, body parts, clothing or similar articles to come in to contact with moving parts of the go kart, wheels or drive train while the engine is running.

Riders shall stay seated with both hands on the steering wheel and both feet in the go kart at all times, whether moving or stationary, unless the go kart is stopped completely and turned off.

Riders shall not operate the go kart if hair, clothing or other articles can extend past the go kart seat back or under the wheels.

Go karts shall operate out doors and only on smooth, level and dry surfaces.

Go karts shall not be operated on roads, streets, highways, or at any other location where road vehicles are intended to travel, and

Go karts shall be operated only with adequate lighting and under conditions of suitable visibility.

No rider or other person shall contact any portion of the motor, wheels or drive train for any purpose including maintenance until the motor has been turned off and allowed to cool, and the go kart is in a stable and stationary position.

 **WARNING:** Maintain a hold on the steering wheel at all times.

 **WARNING:** Never use near steps or swimming pools.

 **WARNING:** Traffic can be fatal. Do not drive on streets or around cars.

 **WARNING:** Keep your fingers, long hair and other body parts away from the drive system, rotating wheels, and all other moving components.

 **WARNING TO PARENTS:** Kids need to be taught and be frequently reinforced of the importance of safe riding, the rules of the road and the importance of avoiding using the

Ground Force on streets due to dangers and hazards of traffic, especially motor vehicle traffic. Parents and children are urged to read and understand these safety tips together.

Drive defensively. Assume that pedestrians and others are so absorbed in their own world that they are not paying any attention to you and that they will run you down or step out in front of you, all without any warning.

Watch for obstacles such as pot holes, sewer grates, expansion cracks, and road or construction debris (such as nails or other foreign objects) that could catch your wheel or force you to swerve into traffic or lose control.

Never drive with headphones, use a cell phone or apply make-up.

Never carry a passenger.

Never hitch a ride with another vehicle.

Driving the Ground Force may be a hazardous activity and has inherent dangers that no amount of care, caution, instruction or expertise can eliminate. Certain conditions may cause the equipment to fail without fault of the manufacturer. Activities involving the use of electric vehicles carry the risk of injury or death.

7. Razor Limited Warranty and Registration

The manufacturer warrants this product to be free of manufacturing defects for a period of 90 days from date of purchase. This Limited Warranty does not cover normal wear and tear, crash damage, tire tread wear, cables, nor any damage, failure or loss caused by improper assembly, maintenance, storage or use of the Razor Ground Force.

This Limited Warranty will be void if the product is ever:

- used in a manner other than for recreation or transportation;
- modified in any way;
- rented.

Check local laws and regulations to see where you can ride your Ground Force legally.

The manufacturer is not liable for incidental or consequential loss nor damage due directly or indirectly from the use of this product.

To obtain service under this warranty you must, within the warranty period, contact Razor USA LLC directly by e-mail at warranty@razorusa.com. Razor will provide warranty replacement at its sole discretion.

Authorized warranty service is ONLY available from Razor USA LLC.

SB 1918 (California) declaration:

YOUR INSURANCE POLICIES MAY NOT PROVIDE COVERAGE FOR ACCIDENTS INVOLVING THE USE OF THIS SCOOTER/ELECTRIC VEHICLE. TO DETERMINE IF COVERAGE IS PROVIDED, YOU SHOULD CONTACT YOUR INSURANCE COMPANY OR AGENT.

8. Illustrated Parts Breakdown (Figure 14).

(Specifications and parts list subject to change without notice)

Item	Description	Quantity
1.	Wheel	4
2.	Pindle, right	1
3.	Bearing, 608ZZ 8x22	4
4.	Tie-rod	2
5.	Bushing, lower steering	1
6.	Control arm, tie-rod	1
7.	Protector, flexible steering, right	1
8.	Pindle, left	1
9.	Nut, nylock self locking & washer	2
10.	Trigger, speed control	1
11.	Steering wheel	1
12.	Bushing, upper steering	1
13.	Frame	1
14.	Lever, rear brake w/cut-off switch	1
15.	Screw, steering pivot and seat anchor	6
16.	Screw, 5mm for steering cover	2
17.	cover, steering	1
18.	Seat	1
19.	Nut, axle and seat coupling	6
20.	Cover, motor	1
21.	Screw, 6mm for motor cover	4
22.	Battery 12v 7AH	2
23.	Cover, rear axle	2
24.	Motor, special GF 200W+	1
25.	Roller Chain (.25 pitch HD)	1
26.	Spacer/clip	2
27.	Bearing, rear axle 6904ZZ 20x37	2
28.	Plate, motor mounting	1
29.	Screw, 5mm socket head cap	5
30.	Pulley, axle-mounted	1
31.	Axle, rear	1
32.	Switch, On/Off	1
33.	Plug, charger input	1
34.	Circuit breaker	1
35.	Electronic control module GF	1
36.	Jackscrew, belt adjust w/nut	1
37.	Bolt, motor mount pivot	1

- 38. Brake drum1
- 39. Wiring harness (not shown)1
- 40. Seat belt assembly (not shown)1
- 41. Brake band assembly (not shown)1

(Specifications and parts list subject to change without notice)

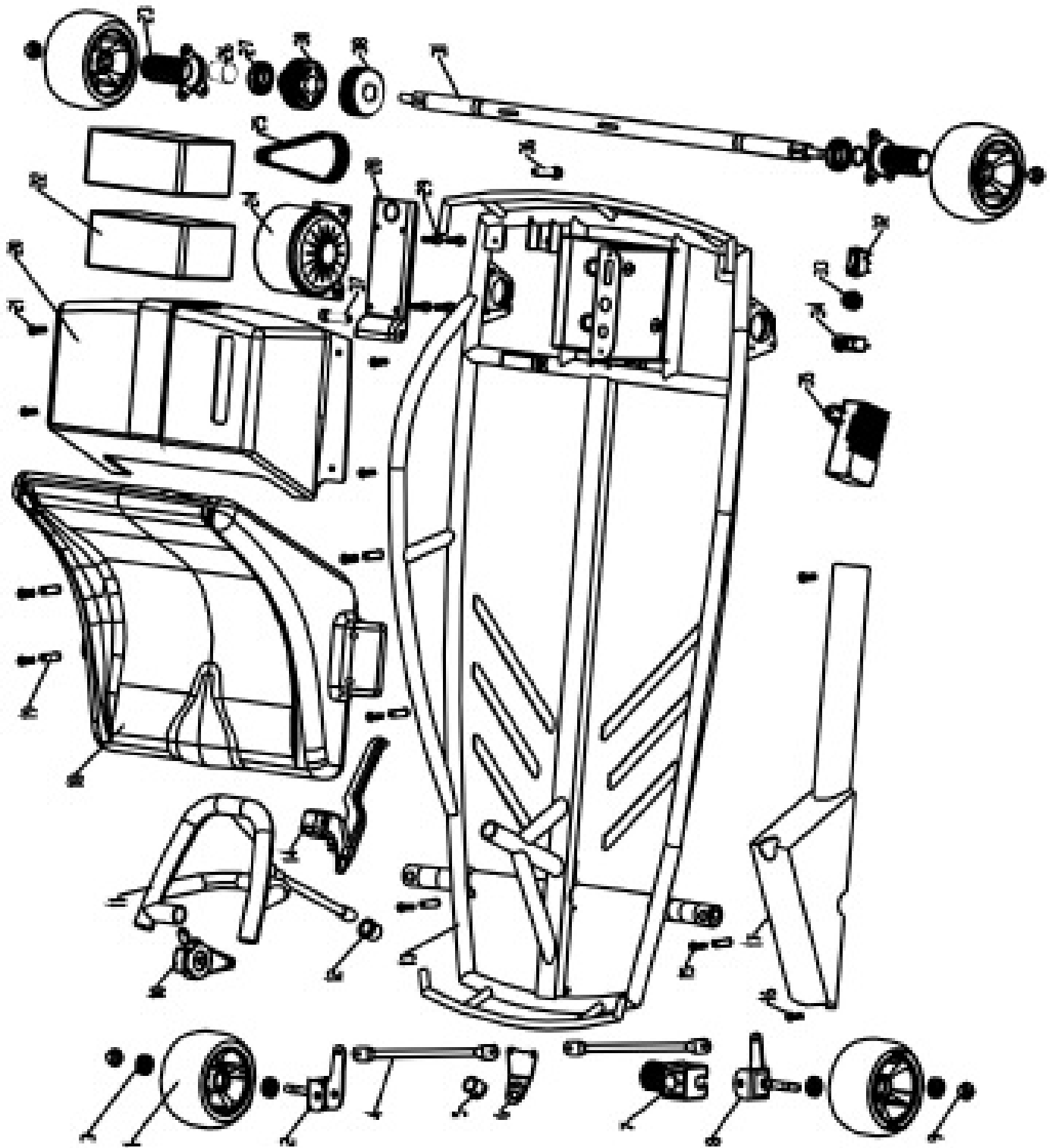

Fig. 14. Illustrated parts breakdown

QUESTIONS?

Please read the owner's manual thoroughly. If you still have questions, check our website for updates and contact information.

Spare tires and batteries are available! Keep your Razor Ground Force running for years with these and other genuine Razor parts.

Visit our website and e-mail us for more information on spare part availability.

Specifications subject to change without notice.

Patent Pending

Rev. 10/25/04 © Copyright 2004 Razor USA. All rights reserved.

Photos by Arthur Cambridge

IMPORTANT!

If your Razor has a problem call Razor USA
Toll Free (866) 467-2967

 **WARNING:** WEIGHT LIMIT 120 pounds maximum rider weight limit. Heavier riders may cause damage not covered by warranty. DO NOT RIDE UNLESS YOU CAN SAFELY RIDE AND CONTROL THE GROUND FORCE. Rider weight does not necessarily mean a persons' size is appropriate to fit or maintain control of the Ground Force. Read additional warnings inside this manual.

