



OPERATING INSTRUCTIONS

FOR

e-pill®

Pager Vibrating Multi-Alarm (12 Alarm) Reminder



Distributor:

e-pill, LLC | 70 Walnut Street | Wellesley, MA 02481, USA

Phone (781) 239-8255, Fax (781) 235-3252

Toll-Free 1-800-549-0095

Order your e-pill Pager Vibrating 12 Alarm Reminder on-line: www.epill.com

e-pill Pager Vibrating Multi-Alarm Reminder - General Information

This section provides important general information about your Vibrating Pager Reminder. The next section “Vibrating Pager Reminder Operation Instructions” explains how to operate your device.

Alarm Switch

Your Vibrating Pager Reminder has a switch on the side labeled B O V. This switch is used to make the Vibrating Pager Reminder Vibrate (V), Beep (B) or turn off the alerts Off (O). The Vibrating Pager Reminder cannot beep and vibrate at the same time.

Timing Functions - Your Vibrating Pager Reminder has four timing modes

The *Timer* – you can set it to alert once, or set it to repeat itself, vibrating or beeping at any interval you choose for as long as you like. Use for simple timing or for pacing any repetitive need. Great for building new habits, as a memory aid or for pacing presentations.

The *Meeting Timer / Interval Timer* – vibrates at the halfway point, again five minutes before time’s up, and at time’s up, for any time interval you set between 10 – 120 minutes. Each of the three vibrations is distinct. Once time’s up, the *Meeting Timer* automatically resets and repeats on the half hour or hour, depending on the setting. Great for monitoring time intervals, meetings, counseling sessions or presentations.

12 Alarms – You can set up to 12 different alarms to vibrate or beep at various times during the day. Use the Auto/Man button to scroll through set alarms – alarms are displayed in order of next to signal. Any alarm programmed in this mode will signal no matter what other mode the unit is in. This allows you to use the Alarms mode with the Timer, Meeting Timer or Stopwatch to creatively program the unit to handle many types of time management challenges.

The *Stopwatch* – The *Stopwatch* can be used for counting time for any event. No alarm can be set with the *Stopwatch*, however, any alarm that has been set in the 12 Alarms mode will signal if the unit is in the *Stopwatch* mode.

Adjustments – Your Vibrating Pager Reminder has 2 modes for making adjustments

Vibration and Beep adjustment is used to set the vibration intensity, the beep volume and number of beeps.

Time and Date adjustment is used to set the time and date.

The 12-Second Delay

When entering a timing or adjustment mode, you have twelve seconds to enter a new setting. If you make no change within 12 seconds, the display will revert back to the mode name – if this happens, simply press the *Auto/Man* button again to return to the mode being set and begin programming again. One push of the light button and the light stays on for 10 seconds and then turns off automatically. It cannot be turned off manually.

Setting Protection for Timer, Meeting Timer and 12 Alarms

To protect settings from accidental erasure (by accidental button presses) the Vibrating Pager Reminder has a “button auto-lock” feature for the Timer, Meeting Timer and the 12 Alarms. The “button auto-lock” only becomes active when one of these three timer functions is programmed. To override this feature and change a setting, both the *Auto/Man* and *Timer* buttons must be pressed *simultaneously* (see operation instructions for details).

Setting the Timers – One additional button press before starting the Timers

When you enter into the Timer and Meeting Timer modes by pressing *Auto/Man* button, one additional button-press is required before the timer can be started. For example, after entering into one of these timer modes by pressing *Auto/Man*, you may see a setting on the display that you would like to use. This setting will not be usable as is. However, if you simply press the *Auto/Man* button again, you

can then press the *Mode* button and the timer will begin. The requirement for one additional button-press is also fulfilled by your changing hours or minutes using the *Timer* button.

Care of Your Vibrating Pager Reminder

About Batteries

Your Vibrating Pager Reminder uses one alkaline AAA battery. Rechargeable batteries of any type are not recommended. If you need to replace the battery and no alkaline battery is available, you may use an ordinary or “heavy-duty” traditional carbon-zinc battery. These types will work, but the useful life will be shorter. Never use a battery that shows signs of leakage. How long a battery will last depends upon how often the light and the alarms are used - these functions consume the most electricity from the battery. An alkaline battery should last for approximately 3-9 months. The Vibrating Pager Reminder does not retain its settings while the battery is removed; you must re-program it when you replace the battery.

Keep your Vibrating Pager Reminder safe

Ensure that your Vibrating Pager Reminder is not exposed to excessive heat. Avoid keeping the Clock in direct sunlight, near a radiator, in the glove compartment of your car, or in other hot places. Your Vibrating Pager Reminder is neither waterproof nor water-resistant. Your warranty does not cover damage caused by heat, a leaking battery, or liquids.

Cleaning your Vibrating Pager Reminder

The Vibrating Pager Reminder, and its garment clip, may be safely cleaned with ordinary isopropyl rubbing alcohol. Liquids must not be allowed to enter the Clock. Don't use solvents, which could damage the Vibrating Pager Reminder. If your Vibrating Pager Reminder will be exposed to abrasion (for example, if you will keep it in your pocket along with your keys and spare change), you may protect the display from scratches with a piece of plastic adhesive tape, cut to size. When the tape becomes scratched, just peel it off and replace it.

Ways to use the Vibrating Pager Reminder

- Use the Meeting Timer to track time during meetings, presentations, or during any interval from 10 to 120 minutes.
- Use the Timer function to time anything; cooking, exercise, meditation, work projects...
- Your Vibrating Pager Reminder is great for reminding you to take medication or vitamins. You can set multiple Alarms for this purpose, or you can use the Timer set to repeat (RPT) the interval between medication doses.
- Use your Vibrating Pager Reminder to practice a new habit. Set the Timer to any interval you'd like, then to repeat (RPT), and you will be reminded to practice your new habit over and over.
- Use any of the 12 Alarms in combination with the Timer or Meeting Timer.
- Use multiple Alarms to structure the many things you have to remember throughout the day.
- Use your Vibrating Pager Reminder as a silent alarm clock. Set an Alarm time and vibration to 1=low and place under your pillow. Be sure to set vibration switch to V.
- Use the Stopwatch to count billable time on work projects.
- The Vibrating Pager Reminder is perfect for people with attention deficit disorders, memory problems, or people who have a hard time hearing an audio alarm.
- Excellent for psychotherapists, counselors, MD's, lawyers, accountants, masseuses, physical trainers, physical therapists, business people, teachers, speakers, chiropractors, chefs, lab personnel, shop workers....

If you find an unusual use for your Vibrating Pager Reminder please let us know.

Vibrating Pager Reminder Operation Instructions

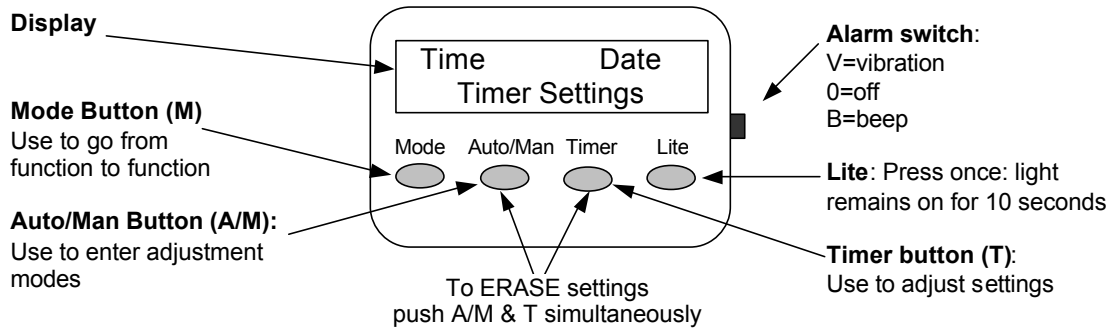

Basics

Install a AAA battery in the back of your Vibrating Pager Reminder.

Your Vibrating Pager Reminder has six modes, which can be accessed by pressing the mode button. The six modes are:

- Vibration and Beep adjustment (VIB & BEEP): use to adjust Vibration Speed (1 = low, 2 = medium, 3 = high), Beep Volume (1-3), and Number of beeps (1-6). A pulsed vibration is normal in low and medium speeds.
- Time and date adjustment (TIME & DATE): use to set time and date. The correct time must be set for the alarm and meeting timer functions to operate properly.
- Timer (TIMER SET): use for simple timing or to repeat a time over and over.
- Meeting Timer (MEET-TIMER): use for meetings, presentations or to track time during any interval.
- 12 Alarms (ALARMS SET): use to set one or more alarms in a 24 hour period.
- Stopwatch (STOP-WATCH): use to count time for any event.

1. How to set Vibration Speed, Beep Volume and Number of Beeps.

Factory settings: Vib. = 1, Beep vol. = 2, Beep number = 3

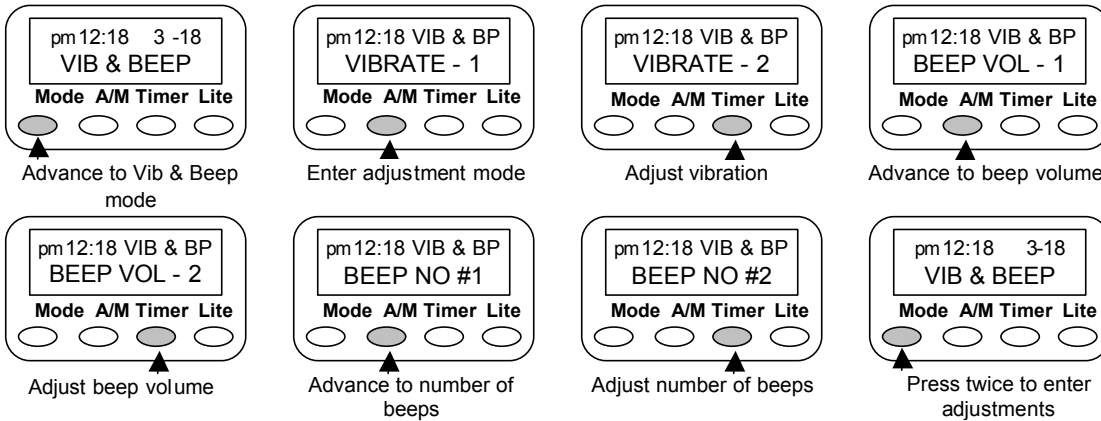

TIP: Let each adjustment sound or vibrate its new setting before going on. For example when changing the number of beeps from 1 to 3 let the Reminder beep twice at 2 before going on to 3.

2. How to set Time and Date.

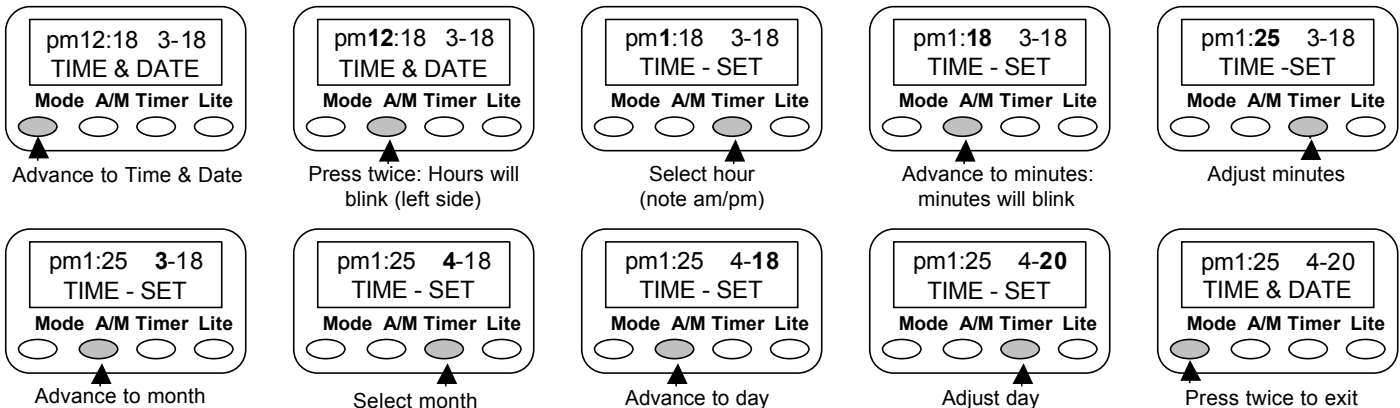

TIP: Hold Timer (T) Button down to rapidly advance counting.

3. How to set Timer

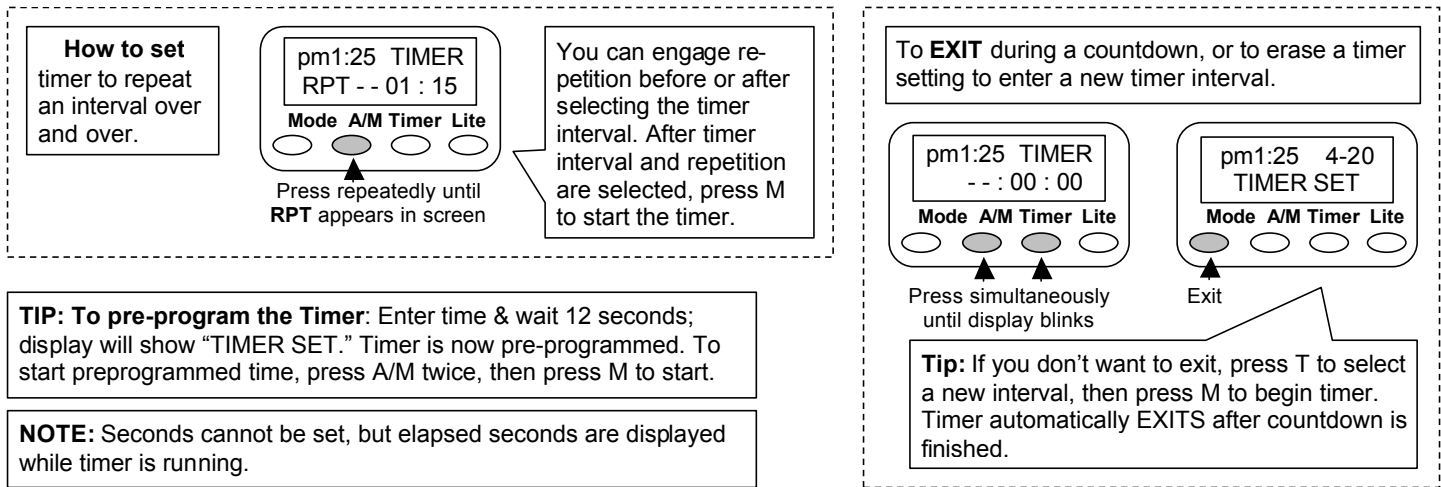
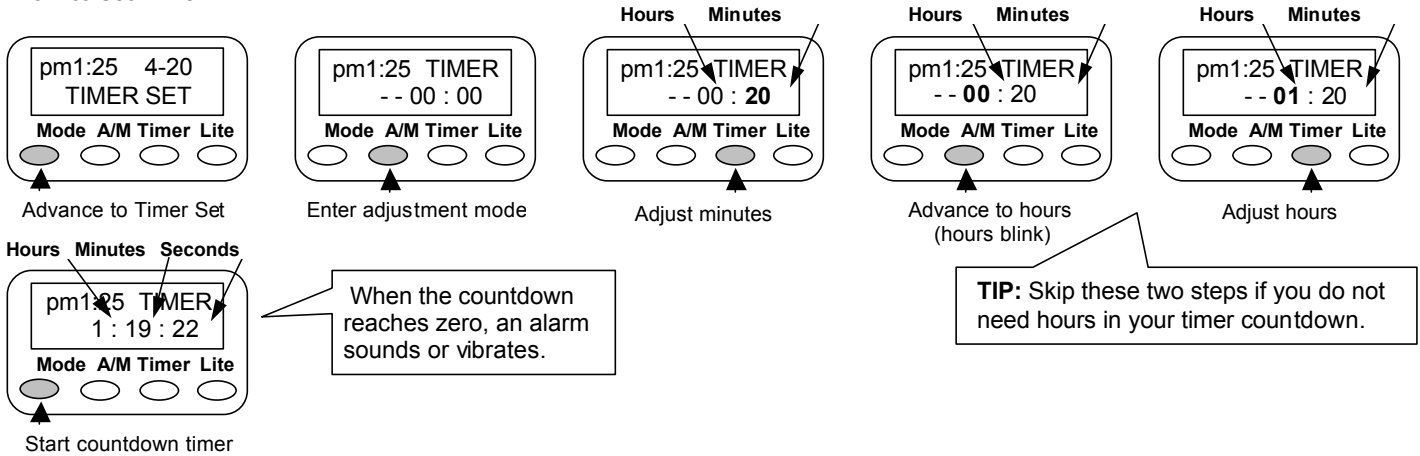

4. How to set Alarms Up to 12 alarms may be set.

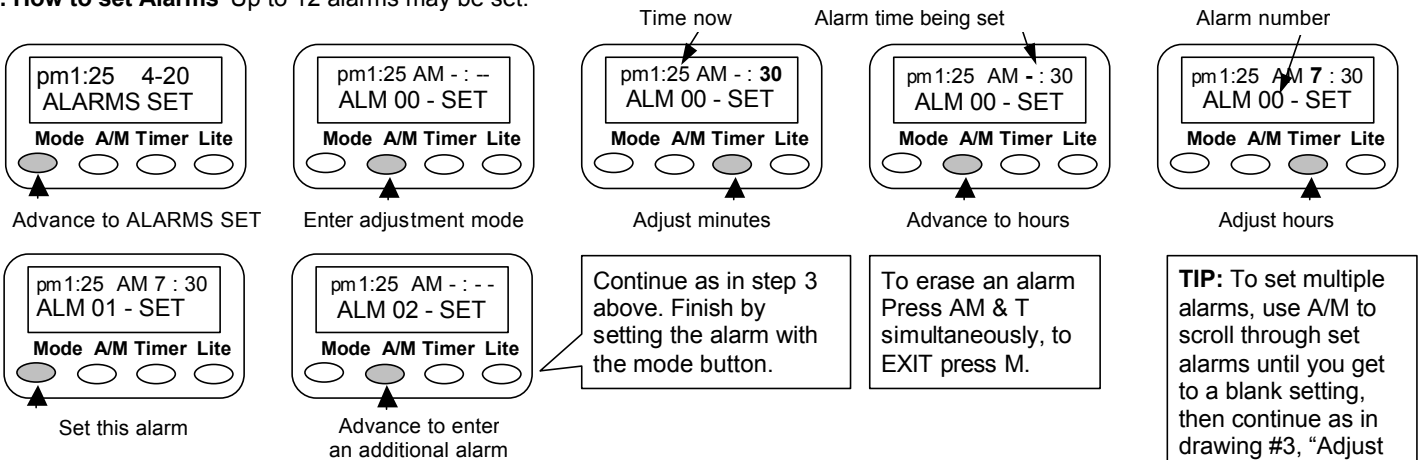

TIP: A set alarm will signal in all other modes unless alarm switch (on side of unit) is set to O (off). An alarm remains set after its time has passed, and will sound again every successive day until it is erased.

Erasing an Alarm: To erase an existing alarm, (a) use the Mode button to advance to "ALARMS SET"; (b) use the Auto/Man button to select the number of the alarm that you wish to erase; (c) Press both the Auto/Man and Timer buttons simultaneously. This will erase the alarm's time, and therefore will erase the alarm itself; (d) Press the Mode button to accept the change, or simply wait twelve seconds for the system to accept the change automatically.

Changing the Time of an Existing Alarm: To change the time of an existing alarm, (a) use the Mode button to advance to "ALARMS SET"; (b) Use the Auto/Man button to select the number of the alarm that you wish to modify; (c) Use the Timer button to change the minutes, then press the Auto/Man button to shift to the hours, which you may change with the Timer button; (d) Press the Mode button to accept the change, or wait twelve seconds for the system to accept the change automatically.

5. How to set Meeting Timer

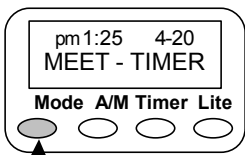

Advance to MEET-TIMER

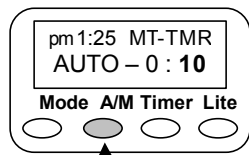

Enter adjustment mode (minutes blink). Press again to switch between AUTO and MAN

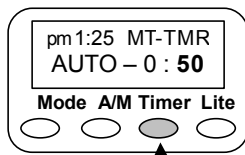

Adjust minutes (blinks). Hold Timer button down for rapid counting

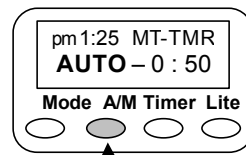

Set to AUTO or MAN (display still blinks)

TIP: Use the **AUTO** setting for automatic starting of meeting timer on the ½ hour or hour. Use the **MAN** setting for starting meeting timer manually at other times.

AUTO SETTING

With this setting, the meeting timer will begin on the hour and repeat every hour thereafter until you cancel it (be sure to set it before the hour begins).

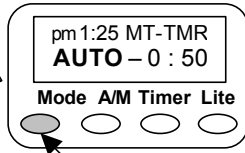

Begin meeting timer (minutes stop blinking)
Meeting timer is in operation

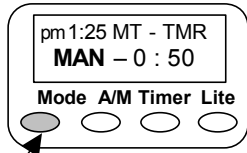

MANUAL SETTING

With this setting the meeting timer will begin when you start it. In one hour from this start time, it will automatically reset & begin again, and will continue to repeat every hour until you cancel it.

TIP: Meeting time cannot be erased or reversed. You can only advance the time. Sorry. Once you go past 2:00 the time begins again at 10 minutes.

Tip: To start the Meeting Timer manually after it has finished running press A/M and T together until minutes blink, then press A/M twice, then press M to begin meeting timer. This resets the meeting timer to begin when you reset it. This action can only be done in the MAN setting.

How to exit meeting timer.

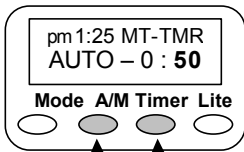

Press together until meeting time blinks

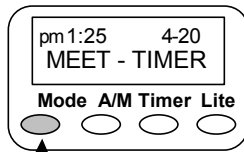

Exit

Tip: To start a new meeting time do not press mode button to exit, instead press T, then press A/M to select AUTO or MAN, then press M to begin meeting timer.

TIP: The meeting time that was last programmed is saved when you exit. When you return to this mode and wish to re-use this meeting time, do these 3 steps. Use this same procedure for "MAN" settings that have been saved.

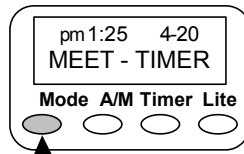

Return to MEET-TIMER

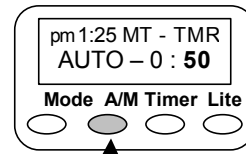

Press three times for saved time (minutes blink)

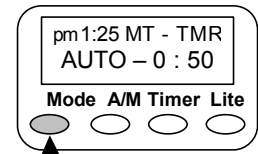

Begin meeting timer (minutes stop blinking)

Notes

1. The meeting timer signals at 1/2 way through the meeting, at 5 minutes before the end and at the end of the meeting. Each signal is distinct.
2. Once a meeting time is started, for both AUTO and MAN settings, it will repeat every half hour for durations of 10-30 minutes, and repeat every hour for durations of 31-60 minutes, and repeat every other hour for durations of 61-120 minutes.
3. In AUTO setting, the meeting timer begins on the half hour or hour automatically. If you begin your meetings at other times, use the MAN setting.
4. When set to MAN, the meeting timer begins when you press M to enter the meeting time you have selected. It stays on the time schedule as outlined in note 2. above, except that the "on the hour" or "on the half hour" is now adjusted to the time you have started the meeting timer. When you press M to enter a meeting time in MAN mode, the "on the hour" readjusts to this time and then repeats on this time schedule.
5. The meeting timer can be set for any time between 10 minutes and 120 minutes. To change a meeting time, use T to count up to a time you want. If the meeting timer is in operation (time is not blinking) and you want to change the time, press A/M and T simultaneously, then press T to count up to the meeting time you wish, then press M to enter selection and begin the meeting timer.
6. When the meeting timer is in operation, the display does not show time countdown. Instead it shows only the meeting time and "AUTO" or "MAN". It is a good idea to practice using the meeting timer a few times before using it in an actual meeting.
7. Meeting times of 30, 60, 120 minutes will repeat back to back automatically. For all other meeting times, there will be a space before the meeting timer repeats the meeting time. For example, for a meeting time of "AUTO - 50" the meeting timer will begin on the hour and go for 50 minutes, wait 10 minutes, then begin again on the next hour. For a meeting time of "MAN - 50" it will begin when it is set, go for 50 minutes, wait 10 minutes, then begin again. If you want a meeting time to repeat back to back and it is not 30, 60 or 120 minutes, do the following: Set to MAN and any meeting time. When this meeting time ends (and sends you its final signal), press A/M and T simultaneously (until time blinks), then press A/M twice, then press M once to begin the same meeting time immediately.
8. Extend your battery life by exiting the meeting timer when it's not being used.

6. How to set Stopwatch

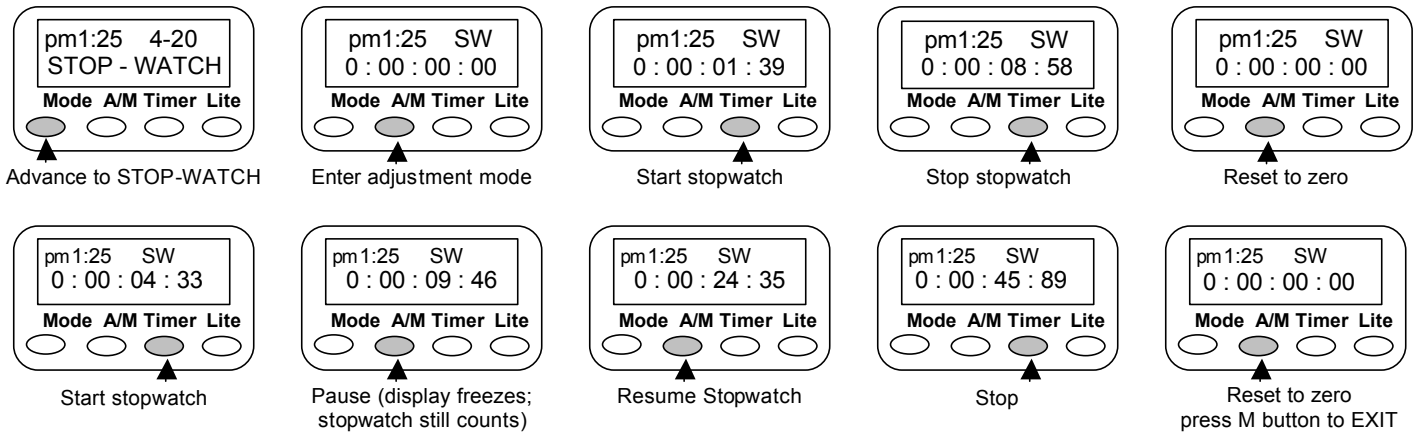

TIP: You can start the stopwatch and then leave this mode and it will continue to count. If you do not need the stopwatch to run while using other functions, stop it before leaving this mode.

Limited Warranty

Time Now Corporation (TNC) warrants that this timer is free from defects in material and workmanship that result in product failure during normal use, according to the following terms and conditions:

- The limited warranty for this product extends for 1 year beginning on the date of purchase of the product.
- The limited warranty extends to the original purchaser of the product and is not assignable or transferable to any subsequent purchaser/user.
- During the limited warranty, TNC will repair, or replace the timer unit, at TNC's option; or replace any defective parts, or any parts that will not properly operate for their intended use with new items if such repair or replacement is needed because of product malfunction or failure during normal usage. No charge will be made to the consumer for any such parts or repair labor. The limited warranty does not cover defects in appearance, cosmetic, decorative or structural items. TNC shall not be liable for any other losses or damages. These remedies are the consumer's exclusive remedies for breach of warranty.
- The consumer shall have no coverage or benefits under this limited warranty if any of the following conditions are applicable: (a) The product has been subject to abnormal use, abnormal conditions, improper storage, exposure to moisture or dampness, unauthorized modifications, unauthorized repair, misuse, neglect, abuse, accident, alteration, improper installation, or other acts which are not the fault of TNC, including damage caused by shipping; (b) the product has been damaged from external causes such as collision with an object, or from fire, flooding, sand, dirt, windstorm, lightning, earthquake or damage from exposure to weather conditions, an Act of God, or battery leakage, or theft.
- If a problem develops during the limited warranty period, the consumer shall take the following procedure:
 - Return the product to TNC, 207 Terrace Ave., San Rafael, CA 94901. TNC will pay for shipping both ways.
 - Include a return address, phone #, description of the problem.
 - TNC will repair or replace the product under the limited warranty within 15 days after receipt of the product by TNC.
- TNC shall not be liable for special, incidental or consequential damages, including but not limited to, loss of anticipated benefits or profits, loss of savings or revenue, punitive damages, loss of use of the product or any associated equipment, cost of capital, cost of any substitute equipment, downtime, the claims of any third parties including customers, and injury to property, resulting from the purchase or use of the product or arising from breach of the warranty, breach of contract, negligence, strict tort, or any other legal or equitable theory, even if TNC knew of the likelihood of such damages. TNC shall not be liable for delay in rendering service under the limited warranty, or loss of use during the period that the product is being repaired.

Manufacturer: Time Now Corporation, 207 Terrace Avenue, San Rafael CA 94901, USA