

# REFLEX

Analytical Corporation

Serving you across the Spectrum

## Spectroscopy Products Guide

P.O. Box 119 • Ridgewood, New Jersey 07451 • USA

Tel: 201 444 8958 • Fax: 201 670 6737

E-mail: [reflex.usa@juno.com](mailto:reflex.usa@juno.com)

Internet: [www.reflexusa.com](http://www.reflexusa.com)

## UV-VIS-NIR-IR Cells

Cell Type	Path	"Q" UV Silica	"I" IR Silica	"H" Quartz	"G" Glass
<b>Type 1</b>					
Standard	1mm	T1Q-1	T1I-1	T1H-1	T1G-1
	2mm	T1Q-2	T1I-2	T1H-2	T1G-2
	5mm	T1Q-5	T1I-5	T1H-5	T1G-5
	10mm	T1Q-10	T1I-10	T1H-10	T1G-10
	10mmSC	T1Q-10SC	T1I-10SC	N/A	N/A
	10mmGS	T1Q-10GS	T1I-10GS	N/A	N/A
	10mmMS	T1Q-10MS	N/A	N/A	T1G-10MS
	10mmASC	T1Q-10ASC	N/A	N/A	T1G-10ASC
	20mm	T1Q-20	T1I-20	T1H-20	T1G-20
	30mm	T1Q-30	T1I-30	T1H-30	T1G-30
	40mm	T1Q-40	T1I-40	T1H-40	T1G-40
	50mm	T1Q-50	T1I-50	T1H-50	T1G-50
	100mm	T1Q-100	T1I-100	T1H-100	T1G-100
<b>Type 3</b>					
Fluorimeter	5mm	T3Q-5	T3I-5	T3H-5	T3G-5
	10mm	T3Q-10	T3I-10	T3H-10	T3G-10
	10mmGS	T3Q-10GS	N/A	N/A	N/A
	10mmMS	T3Q-10MS	N/A	N/A	T3G-10MS
	10mmASC	T3Q-10ASC	N/A	N/A	T3G-10ASC
	20mm	T3Q-20	T3I-20	T3H-20	T3G-20
	40mm	T3Q-40	T3I-40	T3H-40	T3G-40
	50mm	T3Q-50	T3I-50	T3H-50	T3G-50
<b>Type 9</b>					
Semi Micro	5mm	T9Q-5	T9I-5	T9H-5	T9G-5
	10mm	T9Q-10	T9I-10	T9H-10	T9G-10
	10mmF	T9Q-10F	N/A	N/A	N/A
	10mmMS	T9Q-10MS	N/A	N/A	T9G-10MS
	10mmMSF	T9Q-10MSF	N/A	N/A	T9G-10MSF
	10mmASC	T9Q-10ASC	N/A	N/A	T9G-10ASC
	10mmASCF	T9Q-10ASCF	N/A	N/A	T9G-10ASCF
	20mm	T9Q-20	T9I-20	T9H-20	T9G-20
	30mm	T9Q-30	T9I-30	T9H-30	T9G-30
	40mm	T9Q-40	T9I-40	T9H-40	T9G-40
	50mm	T9Q-50	T9I-50	T9H-50	T9G-50
<b>Type 9</b>					
Black Masked	5mm	T9BMQ-5	T9BMI-5	T9BMH-5	T9BMG-5
	10mm	T9BMQ-10	T9BMI-10	T9BMH-10	T9BMG-10
	20mm	T9BMQ-20	T9BMI-20	T9BMH-20	T9BMG-20
	40mm	T9BMQ-40	T9BMI-40	T9BMH-40	T9BMG-40
	50mm	T9BMQ-50	T9BMI-50	T9BMH-50	T9BMG-50
<b>Type 17</b>					
Micro-25mm high	5mm	T17Q-5	T17I-5	T17H-5	T17G-5
	10mm	T17Q-10	T17I-10	T17H-10	T17G-10
	20mm	T17Q-20	T17I-20	T17H-20	T17G-20
	30mm	T17Q-30	T17I-30	T17H-30	T17G-30
	40mm	T17Q-40	T17I-40	T17H-40	T17G-40
	50mm	T17Q-50	T17I-50	T17H-50	T17G-50
<b>Type 17</b>					
Black Masked	5mm	T17BMQ-5	T17BMI-5	T17BMH-5	T17BMG-5
	10mm	T17BMQ-10	T17BMI-10	T17BMH-10	T17BMG-10
	20mm	T17BMQ-20	T17BMI-20	T17BMH-20	T17BMG-20
	30mm	T17BMQ-30	T17BMI-30	T17BMH-30	T17BMG-30
	40mm	T17BMQ-40	T17BMI-40	T17BMH-40	T17BMG-40
	50mm	T17BMQ-50	T17BMI-50	T17BMH-50	T17BMG-50
<b>Type 18</b>					
Micro-45mm high	5mm	T18Q-5	T18I-5	T18H-5	T18G-5
	10mm	T18Q-10	T18I-10	T18H-10	T18G-10
	10mmF	T18Q-10F	N/A	N/A	N/A
	20mm	T18Q-20	T18I-20	T18H-20	T18G-20
	30mm	T18Q-30	T18I-30	T18H-30	T18G-30
	40mm	T18Q-40	T18I-40	T18H-40	T18G-40
	50mm	T18Q-50	T18I-50	T18H-50	T18G-50
<b>Type 18</b>					
Black Masked	5mm	T18BMQ-5	T18BMI-5	T18BMH-5	T18BMG-5
	10mm	T18BMQ-10	T18BMI-10	T18BMH-10	T18BMG-10
	20mm	T18BMQ-20	T18BMI-20	T18BMH-20	T18BMG-20
	40mm	T18BMQ-40	T18BMI-40	T18BMH-40	T18BMG-40
<b>Type 20C</b>					
Demountable	.01mm	T20CQ-01	T20CI-01	T20CH-01	T20CG-01
	.1mm	T20CQ-1	T20CI-1	T20CH-1	T20CG-1
	.5mm	T20CQ-5	T20CI-5	T20CH-5	T20CG-5
	1.0mm	T20CQ-10	T20CI-10	T20CH-10	T20CG-10
<b>Type 170.700</b>					
Flow-Through	.01mm	T170.700Q-001	N/A	N/A	N/A
	.1mm	T170.700Q-01	N/A	N/A	N/A
	.2mm	T170.700Q-02	N/A	N/A	N/A
	.5mm	T170.700Q-05	N/A	N/A	N/A
	1.0mm	T170.700Q-1	N/A	N/A	N/A
	2.0mm	T170.700Q-2	N/A	N/A	N/A
<b>Type 176.700</b>					
Flow-Through	10mm	T176.700Q-10	N/A	N/A	T176.700G-10

SC-SCREW CAP GS-GRADED SEAL F-FLUORIMETER MS-MAGNETIC STIRRER MSF-MAGNETIC STIRRER FLUORIMETER

ASC-ANAEROBIC SCREW CAP ASCF-ANAEROBIC SCREW CAP FLUORIMETER N/A-NOT AVAILABLE

5% discounting applies for an individual part number on order quantity 10 or more for all UV-Vis-NIR-IR Cells

### Type 1 Standard

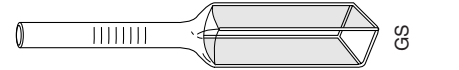
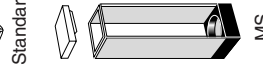

Standard cell with a fitted cover, screw cap, graded seal, magnetic stirrer or anaerobic screw cap. Satin finish on two sides.

Path (mm)	Width (mm)	Height (mm)	Capacity (ml)
1	12.5	45	.4
2	12.5	45	.7
5	12.5	45	1.7
10	12.5	45	3.5
20	12.5	45	7.0
30	12.5	45	10.5
40	12.5	45	14.0
50	12.5	45	17.5
100	12.5	45	35.0

Standard MS

GS

SC ASC

## GENERAL INFORMATION

### Flow-Through Cells

Black Masked Cells with M6 x 1 screw connectors (2) and FEP tubing 1.9mm OD, 1.1mm ID x 500mm length. When ordering, specify the center height and instrument make/model.

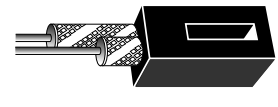

Part No. 170.700 (17.5 x 3.5mm) aperture			
Path (mm)	Width (mm)	Height (mm)	Capacity (ml)
.01	12.5	35	.0006
.05	12.5	35	.003
.1	12.5	35	.006
.2	12.5	35	.012
.5	12.5	35	.03
1	12.5	35	.06
2	12.5	35	.12

Part No. 176.700 (11 x 3.5mm) aperture			
Path (mm)	Width (mm)	Height (mm)	Capacity (ml)
10	12.5	35	.39

### Type 17 Micro - 25mm

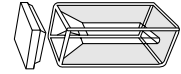

Micro  
(25mm high)



BM  
(25mm high)  
Black Masked

Cell with a fitted cover. Satin finish on two sides. Type 17BM same as Type 17 in self masking black material. Inside width 2mm.

Path (mm)	Width (mm)	Height (mm)	Capacity (ml)
5	12.5	25	.2
10	12.5	25	.4
20	12.5	25	.8
30	12.5	25	1.2
40	12.5	25	1.6
50	12.5	25	2.0

### Type 3 Fluorimeter

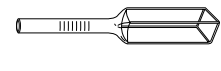
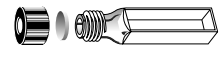
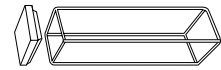

Cell with a fitted cover, graded seal, anaerobic screw cap or magnetic stirrer. All sides polished.

Path (mm)	Width (mm)	Height (mm)	Capacity (ml)
5	12.5	45	1.7
10	12.5	45	3.5
20	12.5	45	7.0
40	12.5	45	14.0

Standard MS

ASC

ASC

GS

### Type 9 Semi Micro

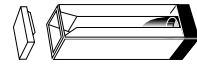
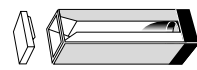
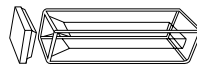

Cell with a fitted cover, magnetic stirrer or anaerobic screw cap. Satin finish on two sides. Type 9BM same as Type 9 in self masking black material. Type 9F, 9MSF and 9ASC fluorimeter cells offers all sides polished. Inside width 4mm.

Path (mm)	Width (mm)	Height (mm)	Capacity (ml)
5	12.5	45	.7
10	12.5	45	1.4
20	12.5	45	2.8
30	12.5	45	4.2
40	12.5	45	5.6
50	12.5	45	7.0

9/9F

MS ASC

MSF

ASC

ASC

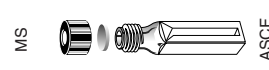

ASC

ASC

ASC

ASC

ASC

ASC

ASC

### Type 18 Micro-45mm

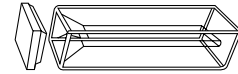

18/18F  
(45mm high)



BM  
(45mm high)  
Black Masked

Cell with a fitted cover. Satin finish on two sides. Type 18F fluorimeter cell offers all sides polished. Type 18BM same as Type 18 in self masking black material. Inside width 2mm.

Path (mm)	Width (mm)	Height (mm)	Capacity (ml)
5	12.5	45	.35
10	12.5	45	.7
20	12.5	45	1.4
30	12.5	45	2.1
40	12.5	45	2.8
50	12.5	45	3.5

### Type 20C Demountable

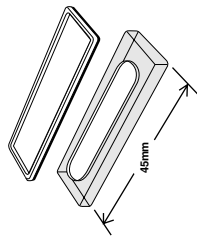

Type 20C  
Demountable

A fully enclosed two component cell consisting of a fused, trough and demountable window. Precision fabrication and surface quality offers an assured seal when assembled. Polished finished on two sides. Recommended Part No. 5705 Type 20C Cell Holder.

Path (mm)	Width (mm)	Height (mm)	Capacity (ml)
.01	12.5	45	.003
.1	12.5	45	.03
.5	12.5	45	.15
1.0	12.5	45	.3

SC-SCREW CAP GS-GRADED SEAL F-FLUORIMETER MS-MAGNETIC STIRRER MSF-MAGNETIC STIRRER FLUORIMETER  
ASC-ANAEROBIC SCREW CAP ASC-ANAEROBIC SCREW CAP FLUORIMETER N/A-NOT AVAILABLE

Cell Type	Path	"Q" UV Silica	"I" IR Silica	"H" Quartz	"G" Glass
Type 21 Standard	1mm	T21Q-1	T21I-1	T21H-1	T21G-1
	2mm	T21Q-2	T21I-2	T21H-2	T21G-2
	5mm	T21Q-5	T21I-5	T21H-5	T21G-5
	10mm	T21Q-10	T21I-10	T21H-10	T21G-10
	10mmMS	T21Q-10MS	N/A	N/A	T21G-10MS
	20mm	T21Q-20	T21I-20	T21H-20	T21G-20
	30mm	T21Q-30	T21I-30	T21H-30	T21G-30
	40mm	T21Q-40	T21I-40	T21H-40	T21G-40
	50mm	T21Q-50	T21I-50	T21H-50	T21G-50
Type 23 Fluorimeter	5mm	T23Q-5	T23I-5	T23H-5	T23G-5
	10mm	T23Q-10	T23I-10	T23H-10	T23G-10
	10mmMS	T23Q-10MS	N/A	N/A	T23G-10MS
	20mm	T23Q-20	T23I-20	T23H-20	T23G-20
	40mm	T23Q-40	T23I-40	T23H-40	T23G-40
	50mm	T23Q-50	T23I-50	T23H-50	T23G-50
Type 28 Anaerobic Fluorimeter	10mm	T28Q-10	N/A	N/A	T28G-10
Type 29 Semi-Micro	1mm	T29Q-1	T29I-1	T29H-1	T29G-1
	2mm	T29Q-2	T29I-2	T29H-2	T29G-2
	5mm	T29Q-5	T29I-5	T29H-5	T29G-5
	10mm	T29Q-10	T29I-10	T29H-10	T29G-10
	10mmMS	T29Q-10MS	N/A	N/A	T29G-10MS
	10mmF	T29Q-10F	N/A	N/A	T29G-10F
	10mmMSF	T29Q-10MSF	N/A	N/A	T29G-10MSF
	20mm	T29Q-20	T29I-20	T29H-20	T29G-20
	30mm	T29Q-30	T29I-30	T29H-30	T29G-30
	40mm	T29Q-40	T29I-40	T29H-40	T29G-40
	50mm	T29Q-50	T29I-50	T29H-50	T29G-50
Type 29 Black Masked	5mm	T29BMQ-5	N/A	N/A	T29BMG-5
	10mm	T29BMQ-10	T29BMI-10	T29BMH-10	T29BMG-10
	20mm	T29BMQ-20	N/A	N/A	T29BMG-20
	40mm	T29BMQ-40	N/A	N/A	T29BMG-40
	50mm	T29BMQ-50	N/A	N/A	T29BMG-50
<p><b>SC-SCREW CAP • ASC-ANAEROBIC SCREW CAP • F-FLUORIMETER • MS-MAGNETIC STIRRER</b>  <b>MSF-MAGNETIC STIRRER FLUORIMETER • N/A-NOT AVAILABLE</b></p>					
Cell Type	Path	"Q" UV Silica	"I" IR Silica	"H" Quartz	"G" Glass
Type 30 Micro	1mm	T30Q-1	T30I-1	T30H-1	T30G-1
	2mm	T30Q-2	T30I-2	T30H-2	T30G-2
	5mm	T30Q-5	T30I-5	T30H-5	T30G-5
	10mm	T30Q-10	T30I-10	T30H-10	T30G-10
	10mmF	T30Q-10F	N/A	N/A	T30G-10F
	20mm	T30Q-20	T30I-20	T30H-20	T30G-20
	30mm	T30Q-30	T30I-30	T30H-30	T30G-30
	40mm	T30Q-40	T30I-40	T30H-40	T30G-40
	50mm	T30Q-50	T30I-50	T30H-50	T30G-50
Type 30 Black Masked	5mm	T30BMQ-5	N/A	N/A	T30BMG-5
	10mm	T30BMQ-10	T30BMI-10	T30BMH-10	T30BMG-10
	20mm	T30BMQ-20	N/A	N/A	T30BMG-20
	40mm	T30BMQ-40	N/A	N/A	T30BMG-40
	50mm	T30BMQ-50	N/A	N/A	T30BMG-50
Type 32 Cylindrical	10mm	T32Q-10	T32I-10	T32H-10	T32G-10
	20mm	T32Q-20	T32I-20	T32H-20	T32G-20
	50mm	T32Q-50	T32I-50	T32H-50	T32G-50
	100mm	T32Q-100	T32I-100	T32H-100	T32G-100
Type 34 Cylindrical	50mm	T34Q-50	T34I-50	T34H-50	T34G-50
	50mmSC	T34Q-50SC	T34I-50SC	T34H-50SC	N/A
	100mm	T34Q-100	T34I-100	T34H-100	T34G-100
	100mmSC	T34Q-100SC	T34I-100SC	T34H-100SC	N/A
	100mmASC	T34Q-100ASC	T34I-100ASC	T34H-100ASC	N/A
Type 37 Micro Cylindrical	1mm	T37Q-1	T37I-1	T37H-1	T37G-1
	2mm	T37Q-2	T37I-2	T37H-2	T37G-2
	5mm	T37Q-5	T37I-5	T37H-5	T37G-5
	10mm	T37Q-10	T37I-10	T37H-10	T37G-10
Type 44 Flow Through	5mm	T44Q-5	T44I-5	T44H-5	T44G-5
	10mm	T44Q-10	T44I-10	T44H-10	T44G-10
Type 44 Black Masked	10mm	T44BMQ-10	T44BMI-10	T44BMH-10	T44BMG-10
<p>5708 10mm                      5709 50mm                      5707 Cylindrical Cell Holder                      100mm Cylindrical Cell Holder                      8500 Adjustable Cuvette Holder                      8501 1-100mm                      8502 10-100mm Universal Cuvette/Cylindrical Cell Holder</p>					

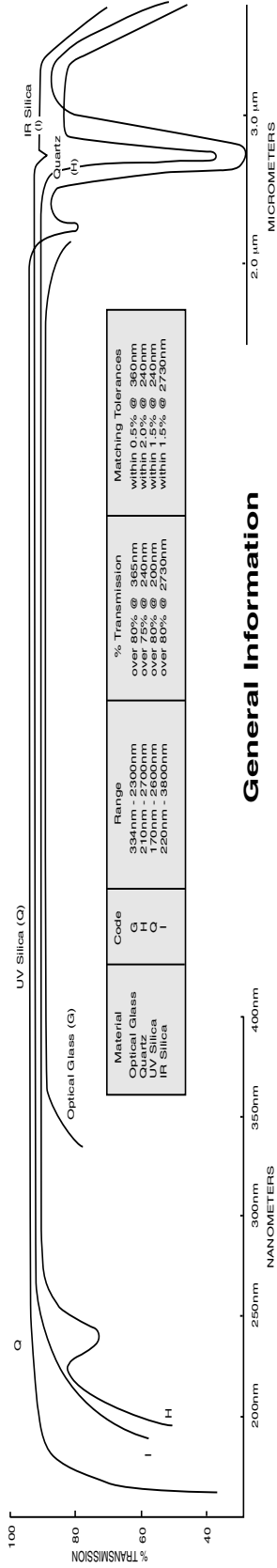

**General Information**

Type 29 Semi Micro cell with a tapered teflon stopper or magnetic stirrer. Satin finish on two sides. Type 29F and 29MSF offers all sides polished. Type 29BM same as Type 29 in self masking black material. Inside width 4mm.

**Type 29/29F**

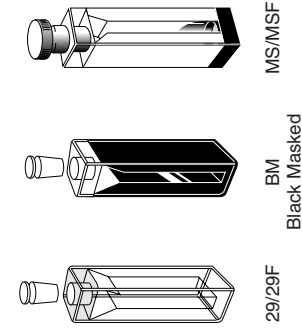

Path (mm)	Width (mm)	Height (mm)	Capacity (ml)
1	12.5	45	.17
2	12.5	45	.35
5	12.5	45	.7
10	12.5	45	1.4
20	12.5	45	2.8
30	12.5	45	4.2
40	12.5	45	5.6
50	12.5	45	7.0

**Type 34 Cylindrical**

Cell with two tapered teflon stoppers, screw caps or anaerobic screw caps. Outside diameter: 22mm.

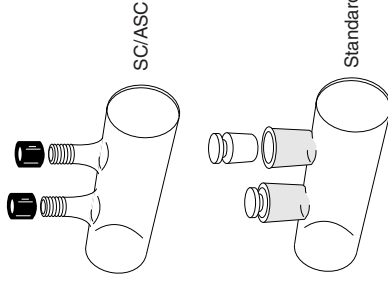

Path (mm)	Width (mm)	Height (mm)	Capacity (ml)
50	22	N/A	14
100	22	N/A	28

Standard cell with a tapered teflon stopper or magnetic stirrer. Satin finish on two sides.

**Type 21 Standard**

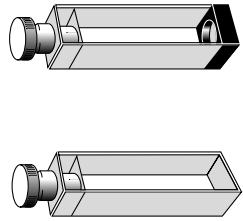

Path (mm)	Width (mm)	Height (mm)	Capacity (ml)
1	12.5	45	.4
2	12.5	45	.7
5	12.5	45	1.7
10	12.5	45	3.5
20	12.5	45	7.0
30	12.5	45	10.5
40	12.5	45	14.0
50	12.5	45	17.5

**Type 23 Fluorimeter**

Cell with a tapered teflon stopper or magnetic stirrer. All sides polished.

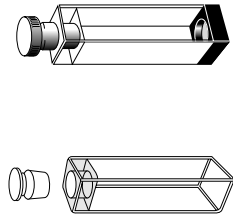

Path (mm)	Width (mm)	Height (mm)	Capacity (ml)
5	12.5	45	1.7
10	12.5	45	3.5
20	12.5	45	7.0
40	12.5	45	14.0
50	12.5	45	17.5

**Type 30/30F Micro**

Type 30 Micro cell with a tapered teflon stopper. Satin finish on two sides. Type 30F fluorimeter cell offers all sides polished. Type 30BM same as Type 30 in self masking black material. Inside width 2mm.

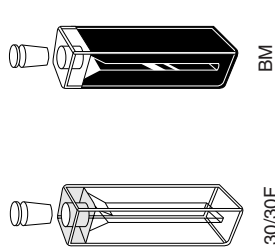

Path (mm)	Width (mm)	Height (mm)	Capacity (ml)
1	12.5	45	.8
2	12.5	45	1.7
5	12.5	45	3.5
10	12.5	45	7
20	12.5	45	14
30	12.5	45	21
40	12.5	45	28
50	12.5	45	35

**Type 37 Micro Cylindrical**

Cell with graded seal. Outside Diameter: 22mm.

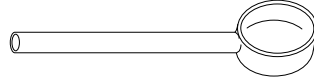

Path (mm)	Width (mm)	Height (mm)	Capacity (ml)
1	22	92	.28
2	22	92	.56
5	22	92	1.4
10	22	92	2.8

**Type 28 Anaerobic Fluorimeter**

Designed for anaerobic conditions. All sides polished. Ground, tapered joints and evacuation tube. Outside dimensions: 125mm high with bulb, 95mm high without bulb.

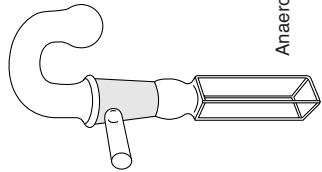

Path (mm)	Width (mm)	Height (mm)	Capacity (ml)
10	12.5	125/95	3.5

Anaerobic Fluorimeter

**Type 44 Flow Through**

Flow through cell with ground and tapered joints. Satin finish on two sides. Type 44BM same as Type 44 in self masking black material. Inside width 4mm. Outside dimensions: 65mm high with tubes, 45mm high without tubes.

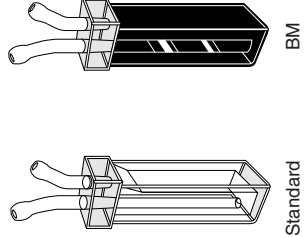

Path (mm)	Width (mm)	Height (mm)	Capacity (ml)
5	12.5	65/45	.9
10	12.5	65/45	1.8
20	12.5	65/45	3.6
40	12.5	65/45	7.2

### 37mm Lamps for all Instruments except Perkin-Elmer

Varian Standard Lamps have 2 base pins and the Data Coded Lamps have 4 base pins

ELEMENT	PART NUMBER	ELEMENT	PART NUMBER	ELEMENT	PART NUMBER
<b>Aluminum</b>	3UNX-AI	Iridium	3QNY-Ir	Selenium	3QNY-Se
Antimony	3QNY-Sb	Iron	3UNX-Fe	Silicon	3QNY-Si
Arsenic	3QNY-As	<b>Lanthanum</b>	3UAX-La	<b>Silver</b>	3UAX-Ag
<b>Barium</b>	3BAX-Ba	Lead	3QNY-Pb	<b>Sodium</b>	3UNX-Na
Beryllium	3QNY-Be	<b>Lithium</b>	3BAX-Li	<b>Strontium</b>	3BAX-Sr
Bismuth	3QNY-Bi	<b>Lutetium</b>	3UAX-Lu	<b>Tantalum</b>	3UNX-Ta
<b>Boron</b>	3UNX-B	Magnesium	3QNY-Mg	<b>Tellurium</b>	3UNX-Te
Cadmium	3QNY-Cd	<b>Manganese</b>	3UNX-Mn	<b>Terbium</b>	3BAX-Tb
<b>Caesium</b>	3BAX-Cs	<b>Mercury</b>	3UNX-Hg	<b>Thallium</b>	3UNX-Tl
<b>Calcium</b>	3UNX-Ca	<b>Molybdenum</b>	3UNX-Mo	<b>Thorium</b>	3UNX-Th
<b>Cerium</b>	3UNX-Ce	<b>Neodymium</b>	3BAX-Nd	<b>Thulium</b>	3UNX-Tm
<b>Chromium</b>	3UNX-Cr	Nickel	3QNY-Ni	Tin	3QNY-Sn
<b>Cobalt</b>	3QNY-Co	<b>Niobium</b>	3UAX-Nb	3UNX-Ti	3UNX-Ti
<b>Copper</b>	3UNX-Cu	<b>Osmium</b>	3UNX-Os	<b>Titanium</b>	3UNX-W
<b>Deuterium</b>	3QDY-D2	<b>Palladium</b>	3UNX-Pd	<b>Tungsten</b>	3UAX-U
<b>Dysprosium</b>	3BAX-Dy	Phosphorus	3QNY-P	<b>Uranium</b>	3UNX-V
<b>Erbium</b>	3BAX-Er	<b>Platinum</b>	3UNX-Pt	<b>Ytterbium</b>	3UNX-Yb
<b>Europium</b>	3BAX-Eu	<b>Potassium</b>	3BAX-K	<b>Yttrium</b>	3BAX-Y
<b>Gadolinium</b>	3UNX-Gd	<b>Praseodymium</b>	3BAX-P	Zinc	3QNY-Zn
<b>Gallium</b>	3UNX-Ga	<b>Rhenium</b>	3UAX-Re	<b>Zirconium</b>	3UNX-Zr
<b>Germanium</b>	3UNX-Ge	<b>Rhodium</b>	3UAX-Rh	Standard 2 Element Lamps	
<b>Gold</b>	3QNY-Au	<b>Rubidium</b>	3BAX-Rb	Standard 3 Element Lamps	
<b>Hafnium</b>	3UAX-Hf	<b>Ruthenium</b>	3UNX-Ru	4 Element Lamps	
<b>Holmium</b>	3BAX-Ho	<b>Samarium</b>	3UNX-Sm	5 Element Lamps	
<b>Indium</b>	3UNX-In	<b>Scandium</b>	3UNX-Sc	6 and 7 Element Lamps	

### 50mm Lamps for use in Perkin-Elmer Instruments Only (Data Coded Lamps available upon request)

P-E Standard Lamps have 9 base pins and the Data Coded Lamps have 12 base pins

ELEMENT	PART NUMBER	ELEMENT	PART NUMBER	ELEMENT	PART NUMBER
Aluminum	5UN-AI	Iridium	5QN-Ir	Selenium	5QN-Se
Antimony	5QN-Sb	Iron	5UN-Fe	Silicon	5QN-Si
Arsenic	5QN-As	Lanthanum	5UA-La	Silver	5UA-Ag
Barium	5BA-Ba	Lead	5QN-Pb	Sodium	5UN-Na
Beryllium	5QN-Be	Lithium	5BA-Li	Strontium	5BA-Sr
Bismuth	5QN-Bi	Lutetium	5UA-Lu	Tantalum	5UN-Ta
Boron	5QN-B	Magnesium	5QN-Mg	Tellurium	5QN-Te
Cadmium	5QN-Cd	Manganese	5UN-Mn	Terbium	5BN-Tb
Caesium	5BN-Cs	Mercury	5UN-Hg	Thallium	5UN-Tl
Calcium	5UN-Ca	Molybdenum	5UN-Mo	Thorium	5UN-Th
Cerium	5UN-Ce	Neodymium	5BN-Nd	Thulium	5UN-Tm
Chromium	5UN-Cr	Nickel	5QN-Ni	Tin	5QN-Sn
Cobalt	5UN-Co	Niobium	5UA-Nb	Titanium	5UN-Ti
Copper	5UN-Cu	Osmium	5UN-Os	Tungsten	5QN-W
Deuterium	TBA	Palladium	5QN-Pd	Uranium	5UA-U
Dysprosium	5BN-Dy	Phosphorus	5QN-P	Vanadium	5UN-V
Erbium	5BN-Er	Platinum	5QN-Pt	Ytterbium	5UN-Yb
Europium	5BA-Eu	Potassium	5BN-K	Yttrium	5BN-Y
Gadolinium	5UN-Gd	Praseodymium	5BN-Pr	Zinc	5QN-Zn
Gallium	5UN-Ga	Rhenium	5UA-Re	Zirconium	5UN-Zr
Germanium	5QN-Ge	Rhodium	5UA-Rh	Standard 2 Element Lamps	
Gold	5QN-Au	Rubidium	5BN-Rb	Standard 3 Element Lamps	
Hafnium	5UA-Hf	Ruthenium	5UN-Ru	4 Element Lamps	
Holmium	5BN-Ho	Samarium	5UN-Sm	5 Element Lamps	
Indium	5UN-In	Scandium	5UN-Sc	6 and 7 Element Lamps	

## DEUTERIUM LAMPS by Cathodeon

INSTRUMENT/MODEL	LAMP	INSTRUMENT/MODEL	LAMP	INSTRUMENT/MODEL	LAMP
Altex, Aminco, A.B.I. Lamps available upon request		Hewlett Packard 1040; 1040A; 1050DA(1050MMD); 1090; 8451A; 8452A; all others		Perkin Elmer 2280; 2380; 3030; 4000; 5000; 5100; 272; 280; 360; 370; 372; 373; 380; 460	PE107 PE109
Applied Research Lab, A.C.S. and Barspec Lamps available upon request		Hewlett Packard 1050VW	HP102	Perkin Elmer 400; 410; 420; 430	
Bausch & Lomb (see Milton Roy below)		Hewlett Packard 1080; 1081(B); 1082; 1084(B)	HP105	Perkin Elmer 137UV; 402; 480	
Milton Roy 200; 700; 710; 2000; Spec.21; Spec 1001; Spec 1201; DE50	MR100	Hewlett Packard 8450A	HP103	Perkin Elmer LS3; LS4; LS5 Perkin Elmer 1100	PE110 PE113
Milton Roy 3000	MR101	Hitachi 150-20; 200; 300; 330; 340; U2000; 3200; L2500; L3000; L4000; L4200; L4250; UL1100	HI103	Perkin Elmer/Hitachi 200; 320; 330; 340; 556; 557	PE108
Beckman DU; DB; DBG; DK	BE100	Other Hitachi, Hi-Tech, IBM, and Isco Lamps available upon request		Phillips-Pye Unicam, Saitron, Secomam and SHIMADZU Lamps available upon request	
Beckman 24; 25; 26; Acta; 34; 35 DU6; DU7; DU8; DU40; DU50; 5200	BE101	JASCO, Jobin Yvon, Joyce Loebel & Knauer Lamps available upon request		Spectra Physics SP8400; 8440; 8450, 8480; 8490	SP100
Beckman DU60; DU70; DU600; DU640; 166HPLC; 168HPLC; 164; 165; 167; Model 20/30; Pace 5000		Kontron, Kratos, LDC, Lear Siegler and Linear, LKB, McPherson, Measurex, Melo Labs and Micromeritics Lamps available upon request		Spectra Physics LC871	SP101
Beckman System Gold		Milton Roy (see Bausch & Lomb or LDC)		Spectra Physics 100; 200; Focus; UV1000; UV2000	SP107
Beckman DU6000; DU7000	BE102	Perkin Elmer M46; M55; M57; 553; 559; 559A; Lambda 1; 575		Spectra Physics 770	
Beckman Models 153-167 (see Altex)		Perkin Elmer M550; M551; M555; M552 from ser#2030	PE112	Spectra Physics 8773XR	SP102
Biorad 1305; 1306 Biorad 1503 Biorad 1790	BR100 BR101 BR102	Perkin Elmer M550S; M551S; M554; M552 to ser#2030	PE101 PE114	Spectra Physics 3100	SP105
Biotronic, Buchler, Camag and Camspec Lamps available upon request		Perkin Elmer Lambda 2		Thermo Environmental, Tracor & Turner Lamps available upon request	
Cecil CE202; CE272; CE212; CE212A CE292; CE373 CE393; CE505; CE2012; CE2112; CE505; CE515; CE545; CE588; CE595 CE599; CE5095; Series 1 Models	CE100	Perkin Elmer Lambda 3 thru 19	PE102	Varian Cary 1 thru 118; Cary 219; UV5; LC5000; LC5500; Polychrom 9060	VA101
Cecil Series 2 Models and Series 1000 - 6000	CE101	Perkin Elmer Lambda 3840	PE103 PE115	Varian Cary 210; 219 (available for serial numbers after 0921009); 2200; 2300	VA102
Carlo Erba, Coleman, Columbia Sci, Dionex and Dupont Lamps available upon request		Perkin Elmer 303; 305; 305A; 305B; 306; 403; 503; 560; 603; 703; 1100B; 2100; 4100	PE104 PE105 N/A PE107	Varian AA275; 475; 775; 400; 75 Series; 875; 975; 1275; 1475; UV Superscan; Spectra A10; A20; A30; A40	VA109 VA103 VA105
EM Science all models	EM100	Perkin Elmer Lambda 2		Spectra A10; A20; A30; A40	
Erma, GBC, Gilford and Gilson Lamps available upon request		Perkin Elmer Lambda 3 thru 19		Varian DMS70; 80; 90; 100S; 200; 300	VA102

## NEW POLISHED OPTICS

SIZE	AgBr	AgCl	Al2O3	AMTIR	BaF2	BK-7	CaF2-IR	CaF2-UV	CdTe	CsI	Ge	KBr	KCl	KRS-5	LIF	MgF2	NaCl	Si	SiO2-IR	SiO2-UV	ZnS	ZnSe	
6 x 1mm	01-1001	02-2001	03-3001	04-4001	05-5001	06-6001	07-7001	08-8001	09-9001	10-10001	11-11001	12-12001	13-13001	14-14001	15-15001	16-16001	17-17001	18-18001	19-19001	20-20001	21-21001	22-22001	23-23001
13 X 1mm	01-1002	02-2002	03-3002	04-4002	05-5002	06-6002	07-7002	08-8002	09-9002	10-10002	11-11002	12-12002	13-13002	14-14002	15-15002	16-16002	17-17002	18-18002	19-19002	20-20002	21-21002	22-22002	23-23002
13 x 2mm	01-1003	02-2003	03-3003	04-4003	05-5003	06-6003	07-7003	08-8003	09-9003	10-10003	11-11003	12-12003	13-13003	14-14003	15-15003	16-16003	17-17003	18-18003	19-19003	20-20003	21-21003	22-22003	23-23003
15 x 2mm	01-1004	02-2004	03-3004	04-4004	05-5004	06-6004	07-7004	08-8004	09-9004	10-10004	11-11004	12-12004	13-13004	14-14004	15-15004	16-16004	17-17004	18-18004	19-19004	20-20004	21-21004	22-22004	23-23004
19 x 2mm	01-1005	02-2005	03-3005	04-4005	05-5005	06-6005	07-7005	08-8005	09-9005	10-10005	11-11005	12-12005	13-13005	14-14005	15-15005	16-16005	17-17005	18-18005	19-19005	20-20005	21-21005	22-22005	23-23005
20 x 2mm	01-1006	02-2006	03-3006	04-4006	05-5006	06-6006	07-7006	08-8006	09-9006	10-10006	11-11006	12-12006	13-13006	14-14006	15-15006	16-16006	17-17006	18-18006	19-19006	20-20006	21-21006	22-22006	23-23006
22 x 2mm	01-1007	02-2007	03-3007	04-4007	05-5007	06-6007	07-7007	08-8007	09-9007	10-10007	11-11007	12-12007	13-13007	14-14007	15-15007	16-16007	17-17007	18-18007	19-19007	20-20007	21-21007	22-22007	23-23007
25 x 2mm	01-1008	02-2008	03-3008	04-4008	05-5008	06-6008	07-7008	08-8008	09-9008	10-10008	11-11008	12-12008	13-13008	14-14008	15-15008	16-16008	17-17008	18-18008	19-19008	20-20008	21-21008	22-22008	23-23008
25 x 4mm	01-1009	02-2009	03-3009	04-4009	05-5009	06-6009	07-7009	08-8009	09-9009	10-10009	11-11009	12-12009	13-13009	14-14009	15-15009	16-16009	17-17009	18-18009	19-19009	20-20009	21-21009	22-22009	23-23009
32 x 3mm	01-1010	02-2010	03-3010	04-4010	05-5010	06-6010	07-7010	08-8010	09-9010	10-10010	11-11010	12-12010	13-13010	14-14010	15-15010	16-16010	17-17010	18-18010	19-19010	20-20010	21-21010	22-22010	23-23010
32 x 3mm	01-1011	02-2011	03-3011	04-4011	05-5011	06-6011	07-7011	08-8011	09-9011	10-10011	11-11011	12-12011	13-13011	14-14011	15-15011	16-16011	17-17011	18-18011	19-19011	20-20011	21-21011	22-22011	23-23011
38 x 6mm	01-1012	02-2012	03-3012	04-4012	05-5012	06-6012	07-7012	08-8012	09-9012	10-10012	11-11012	12-12012	13-13012	14-14012	15-15012	16-16012	17-17012	18-18012	19-19012	20-20012	21-21012	22-22012	23-23012
41 x 3mm	01-1013	02-2013	03-3013	04-4013	05-5013	06-6013	07-7013	08-8013	09-9013	10-10013	11-11013	12-12013	13-13013	14-14013	15-15013	16-16013	17-17013	18-18013	19-19013	20-20013	21-21013	22-22013	23-23013
47 x 6mm	01-1014	02-2014	03-3014	04-4014	05-5014	06-6014	07-7014	08-8014	09-9014	10-10014	11-11014	12-12014	13-13014	14-14014	15-15014	16-16014	17-17014	18-18014	19-19014	20-20014	21-21014	22-22014	23-23014
49 x 6mm	01-1015	02-2015	03-3015	04-4015	05-5015	06-6015	07-7015	08-8015	09-9015	10-10015	11-11015	12-12015	13-13015	14-14015	15-15015	16-16015	17-17015	18-18015	19-19015	20-20015	21-21015	22-22015	23-23015
50 x 3mm	01-1016	02-2016	03-3016	04-4016	05-5016	06-6016	07-7016	08-8016	09-9016	10-10016	11-11016	12-12016	13-13016	14-14016	15-15016	16-16016	17-17016	18-18016	19-19016	20-20016	21-21016	22-22016	23-23016
25x12x2mm	01-1017	02-2017	03-3017	04-4017	05-5017	06-6017	07-7017	08-8017	09-9017	10-10017	11-11017	12-12017	13-13017	14-14017	15-15017	16-16017	17-17017	18-18017	19-19017	20-20017	21-21017	22-22017	23-23017
1"x1"x1mm	01-1018	02-2018	03-3018	04-4018	05-5018	06-6018	07-7018	08-8018	09-9018	10-10018	11-11018	12-12018	13-13018	14-14018	15-15018	16-16018	17-17018	18-18018	19-19018	20-20018	21-21018	22-22018	23-23018
1"x1"x4mm	01-1019	02-2019	03-3019	04-4019	05-5019	06-6019	07-7019	08-8019	09-9019	10-10019	11-11019	12-12019	13-13019	14-14019	15-15019	16-16019	17-17019	18-18019	19-19019	20-20019	21-21019	22-22019	23-23019
29x14x4mm	01-1020	02-2020	03-3020	04-4020	05-5020	06-6020	07-7020	08-8020	09-9020	10-10020	11-11020	12-12020	13-13020	14-14020	15-15020	16-16020	17-17020	18-18020	19-19020	20-20020	21-21020	22-22020	23-23020
29x14x6mm	01-1021	02-2021	03-3021	04-4021	05-5021	06-6021	07-7021	08-8021	09-9021	10-10021	11-11021	12-12021	13-13021	14-14021	15-15021	16-16021	17-17021	18-18021	19-19021	20-20021	21-21021	22-22021	23-23021
30x15x4mm	01-1022	02-2022	03-3022	04-4022	05-5022	06-6022	07-7022	08-8022	09-9022	10-10022	11-11022	12-12022	13-13022	14-14022	15-15022	16-16022	17-17022	18-18022	19-19022	20-20022	21-21022	22-22022	23-23022
38x19x2mm	01-1023	02-2023	03-3023	04-4023	05-5023	06-6023	07-7023	08-8023	09-9023	10-10023	11-11023	12-12023	13-13023	14-14023	15-15023	16-16023	17-17023	18-18023	19-19023	20-20023	21-21023	22-22023	23-23023
38x19x2mm	01-1024	02-2024	03-3024	04-4024	05-5024	06-6024	07-7024	08-8024	09-9024	10-10024	11-11024	12-12024	13-13024	14-14024	15-15024	16-16024	17-17024	18-18024	19-19024	20-20024	21-21024	22-22024	23-23024
38x19x4mm	01-1025	02-2025	03-3025	04-4025	05-5025	06-6025	07-7025	08-8025	09-9025	10-10025	11-11025	12-12025	13-13025	14-14025	15-15025	16-16025	17-17025	18-18025	19-19025	20-20025	21-21025	22-22025	23-23025
38x19x4mm	01-1026	02-2026	03-3026	04-4026	05-5026	06-6026	07-7026	08-8026	09-9026	10-10026	11-11026	12-12026	13-13026	14-14026	15-15026	16-16026	17-17026	18-18026	19-19026	20-20026	21-21026	22-22026	23-23026
41x23x6mm	01-1027	02-2027	03-3027	04-4027	05-5027	06-6027	07-7027	08-8027	09-9027	10-10027	11-11027	12-12027	13-13027	14-14027	15-15027	16-16027	17-17027	18-18027	19-19027	20-20027	21-21027	22-22027	23-23027
41x23x6mm	01-1028	02-2028	03-3028	04-4028	05-5028	06-6028	07-7028	08-8028	09-9028	10-10028	11-11028	12-12028	13-13028	14-14028	15-15028	16-16028	17-17028	18-18028	19-19028	20-20028	21-21028	22-22028	23-23028
45x20x6mm	01-1029	02-2029	03-3029	04-4029	05-5029	06-6029	07-7029	08-8029	09-9029	10-10029	11-11029	12-12029	13-13029	14-14029	15-15029	16-16029	17-17029	18-18029	19-19029	20-20029	21-21029	22-22029	23-23029
50x25x6mm	01-1030	02-2030	03-3030	04-4030	05-5030	06-6030	07-7030	08-8030	09-9030	10-10030	11-11030	12-12030	13-13030	14-14030	15-15030	16-16030	17-17030	18-18030	19-19030	20-20030	21-21030	22-22030	23-23030

Tolerances: All dimensions  $\pm 0.2\text{mm}$ . \*\*Parts are 3mm thickness not 6mm.  
 Higher volume discounts available upon request. Excimer Grade CaF<sub>2</sub>, Fused Silica, MgF<sub>2</sub> and other Custom requirements are encouraged, mechanical drawings with specifications and tolerances are prerequisite. Items are repolished on a best effort basis and the customer assumes risk associated with service.  
 Skill and prudence is administered in every instance to ensure the best result.  
 5% discounting applies for an individual part number on order quantity 10 or more.  
 UV-VUV Grade materials are available. Mounted Vacuum Flange Assemblies also available upon request.  
 REFLEX offers optical repolishing services, call for quotation and return procedure.





**SEALED  
INFRARED  
LIQUID CELLS**



FTIR Sealed Liquid Cells with 38.5 x 19.5 x 4mm windows					
Material	.05mm	.1mm	.2mm	.5mm	1mm
NaCl	5155C	5156C	5157C	5158C	5159C
KBr	5162C	5163C	5164C	5165C	5166C
CaF2	5169C	5170C	5171C	5172C	5173C
BaF2	5176C	5177C	5178C	5179C	5180C
KRS-5	5197C	5198C	5199C	5200C	5201C
ZnSe	7218C	7219C	7220C	7221C	7222C

Dispersive Sealed Liquid Cells with 38.5 x 19.5 x 4mm windows					
Material	.05mm	.1mm	.2mm	.5mm	1mm
NaCl	5155	5156	5157	5158	5159
KBr	5162	5163	5164	5165	5166
CaF2	5169	5170	5171	5172	5173
BaF2	5176	5177	5178	5179	5180
KRS-5	5197	5198	5199	5200	5201
ZnSe	7218	7219	7220	7221	7222

## SANDWICH CELLS FOR DEMOUNTABLE AND SEALED LIQUID CELLS

FTIR Sandwich Cells with 38.5 x 19.5 x 4mm windows					
Material	.05mm	.1mm	.2mm	.5mm	1mm
NaCl	5099C	5100C	5101C	5102C	5103C
KBr	5106C	5107C	5108C	5109C	5110C
CaF2	5113C	5114C	5115C	5116C	5117C
BaF2	5120C	5121C	5122C	5123C	5124C
KRS-5	5141C	5142C	5143C	5144C	5145C
ZnSe	7362C	7363C	7364C	7365C	7366C

Dispersive Sandwich Cells with 38.5 x 19.5 x 4mm windows					
Material	.05mm	.1mm	.2mm	.5mm	1mm
NaCl	5099	5100	5101	5102	5103
KBr	5106	5107	5108	5109	5110
CaF2	5113	5114	5115	5116	5117
BaF2	5120	5121	5122	5123	5124
KRS-5	5141	5142	5143	5144	5145
ZnSe	7362	7363	7364	7365	7366

## LIQUID TRANSMISSION CELL RECONDITIONING SERVICE

REFLEX offers complete cell reconditioning services on most sealed cells. Call for a quotation. Please return cells via U.S. Postal Express Mail Service to the following address: REFLEX Analytical Corporation P.O. Box 119 Ridgewood, NJ 07451. Specify desired pathlength, window material and whether cells are to be calibrated or calibrated and matched. A purchase order must accompany the cells.

DRA	Disassembly and reassembly fee per cell
TBA	Transmission optics repolishing or replacement fee. Determined upon receipt of cell(s) or as quoted.
CALIB	Calibration fee per cell
CALIB-M	Calibration and matching fee per cell

## MICRO FLOW THROUGH AND LONG PATH LIQUID CELLS

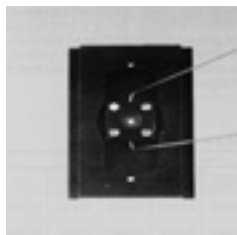

Micro Flow Through Cells with 13mm diameter windows				
Pathlength	1.5mm	1.5mm	3.0mm	3.0mm
Volume	4.5µl	25µl	9µl	50µl
Clear Aperture	2mm	2 x 7mm	2mm	2 x 7mm
NaCl	5A01	5A02	5A03	5A04
KBr	5C01	5C02	5C03	5C04
CaF2	5D01	5D02	5D03	5D04
BaF2	5E01	5E02	5E03	5E04
KRS-5	5G01	5G02	5G03	5G04
ZnSe	5K01	5K02	5K03	5K04

Long Path Absorption Cells with 32mm diameter windows				
Pathlength	Volume ml	NaCl	KBr	Other Materials
10mm	7.5	4007	4008	
25mm	19	4016	4017	
50mm	38	4019	4009	
100mm	76	4018	4010	

## DEMOUNTABLE LIQUID AND MULL CELLS



- 16500C Perkin Elmer Type Demountable Liquid Cell with 14mm FTIR circular aperture. Cell includes a stainless steel holder, rear neoprene gasket, teflon gasket, teflon plugs and teflon spacers ( 2 each .015, .025, .05, .1, .2, 1 each .5 and 1mm ) but without 38.5 x 19.5 x 4mm windows. See page 8 for selection of window materials.
- 16500 Perkin Elmer Type Demountable Liquid Cell with 10 x 22mm Dispersive rectangular aperture. Cell includes a stainless steel holder, rear neoprene gasket, teflon gasket, teflon plugs and teflon spacers ( 2 each .015, .025, .05, .1, .2, 1 each .5 and 1mm ) but without 38.5 x 19.5 x 4mm windows. See page 8 for selection of window materials.
- TBA Replacement Spacers (12/pk). Specify teflon, lead or copper and pathlength (.015, .025, .05, .1, .2, .5 or 1mm ).
- 5216CT Assorted Teflon Spacers (12/pk) for part numbers 16500 and 16500C
- 6401 Beta Cell Mull Kit includes demountable cell mount, one dozen teflon spacers (assorted .015, .025, .05, .1, .2, .5 and 1mm ), slide plate holder but without 25 x 4mm windows. See page 8 for selection of window materials.
- 4041 Mini Mull Cell complete with cell mount, slide plate holder and AgCl windows(6) for pathlengths .025 or .05mm
- 4045 Mini Mull Cell AgCl windows(6)
- 2100 Mini Mull Cell complete with cell mount, slide plate holder and AgBr windows(6) for pathlengths .025 or .05mm
- 2110 Mini Mull Cell AgBr windows(6)

## LIQUID SAMPLING



## VARIABLE PATHLENGTH LIQUID CELLS

The Variable Pathlength Liquid Cell permits continuous adjustment of sample pathlength from 0 - 6mm. The micrometer and vernier scales provide for accurate pathlength setting and readability in graduated divisions of 0.0005mm (1/2 micrometer). The cell's pathlength can be adjusted with precision to provide peak intensity for both weak and strong bands. The volume at maximum pathlength is 4.5ml. The cell's design consists of a stainless steel cylindrical chamber containing parallel windows. For liquid kinetic studies, flow through cells can

be provided upon request. The Variable Pathlength Liquid Cell is preferred for liquids analysis without dilution and an excellent analytical tool for differential analysis.

## Variable Pathlength Liquid Cells

SERIES	NaCl	KBr	CaF <sub>2</sub>	BaF <sub>2</sub>	ZnSe	ZnS	KRS-5
7500 Stainless Steel Cell with non-rotating windows	7500	7501	7502	7503	7509	TBA	TBA

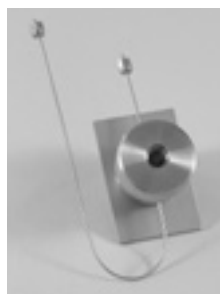

## HIGH PRESSURE LIQUID CELL

REFLEX Analytical has introduced a new High Pressure Liquid Cell for liquid flow through analysis at elevated temperatures and pressures. Its demountable assembly permits pathlength variation with a choice of stainless steel spacers (specify 0.1, 0.2, 0.5, 1, 2, 3, 4, or 5mm when ordering). The cell can operate at temperatures up to 200°C with viton seals, 260°C with kalrez seals, 500°C with metal seals and is rated at 5000 psi maximum. Its design permits direct sample and cell temperature monitoring. To minimize heat transfer to the spectrometer, the 3" x 2" mount is water cooled. A type K thermocouple, stainless steel ports with 1/8" Swagelok fittings, and a programmable temperature controller with RS-232 computer interface accompany the cell as standard components. The cell can be configured for breadboard and FTIR instrumentation. Low pressure, non-heated cell versions with assorted 6 - 1000µm teflon spacers and 1/16" Swagelok or luer fittings are available upon request.

## TEFLON LIQUID CELL

The demountable Teflon Liquid Cell is a development in reply to requests offered by the spectroscopy community for a chemically resistant design. The cell body and spacers are fabricated from Teflon thereby eliminating the risk of liquids and semi-solids from permeating and absorbing into the surfaces typical of metal bodied cells. Analysts have confirmed the teflon body prevents degradation and cross contamination from residual sampling. The order details provide for a 8mm clear aperture demountable

Teflon liquid cell with viton o-ring seals and assorted teflon spacers permitting pathlength variation from 25 - 500µm. The cell can be ordered with luer-lok fittings for static investigations or with tube fittings for flow-through operation (specify 1/16" or 1/8" tubing when ordering). Assembly and operational instructions are enclosed with the cell. The cell requires standard 13mm x 2mm undrilled windows (refer to page 8). Optional kalrez seals for greater chemical resistance and teflon spacers to extend the pathlength range from 6 - 1000µm are available upon request.

**SEALED LIQUID CELLS...PAGE 9**  
**DEMOUNTABLE LIQUID CELLS...PAGE 9**  
**SOLID SAMPLING ACCESSORIES...PAGES 22, 23**  
**GAS CELL SERIES...BACK COVER**

## LIQUIDS AND SOLIDS MIXER MILLS



The Mixer Mill is a development in reply to requests offered by the biological, medical, agricultural and forensic communities to provide for greater productivity, sampling efficiencies and extended grinding duration. Two designs are available and each can grind, mix or homogenize two (2) sample vials containing liquids or solids simultaneously. The Model 200 accommodates a selection of vials providing for sample volume from 0.2ml

- 10ml while Model 301 supports vial capacities up to 20ml. In one single operation, the Model 301 can process up to twenty (20) samples for DNA and RNA biological cell disruption using adapter racks which hold 5 or 10 disposable reaction vials. The mills are particularly useful for wet grinding using stainless steel screw top, teflon sealed vials. The mills include digital keypad entry, 10 seconds - 99 minute timer, safety cover and variable speed programming (3 - 30 vibrations per second). The electronics also feature a memory function for programming three (3) different grinding settings to guarantee reproducibility. A variety of vials and ball pestles has expanded the flexible use of these mills which can produce 5 micron particle size depending upon the sample and grinding duration.

MM200-110V Model 200 Mixer Mill, 110V  
 MM200-220V Model 200 Mixer Mill, 220V  
 MM301-110V Model 301 Mixer Mill, 110V  
 MM301-220V Model 301 Mixer Mill, 220V

## Vial Type for Mixer Mill Model 200 (Part No. 462-XXXX)

Material	1.5ml VV	5ml VV	10ml VV	25ml VV	35ml VV	50ml VV
	0.2-0.5ml SV	0.5-2ml SV	2-4ml SV	4-10ml SV	up to 15ml SV	up to 20ml SV
	1mm max PS	2mm max PS	4mm max PS	6mm max PS	6mm max PS	8mm max PS
	5mm BP	7mm BP	9,10,12mm BP	12, 20mm BP	20, 25mm BP	25, 30mm BP
Agate	0112	0113	0008			
Sinter Alumina	0110	0111	0007			
Stainless Steel	0057	0059	0061	0119		
Chrome Steel	0056	0058	0060	0052		
Tungsten Carbide	0114	0115	0009			
Teflon		0183	0184	0051		
Zirconia			0194	0195		
Stainless Steel Screw Top				0213		
Chrome Steel Screw Top				0237		
Teflon Screw Top				0238		

VV - Vial Volume SV - Sample Volume PS - Particle Size BP - Ball Pestle

## Ball Pestle Type for Mixer Mill Model 200 (Part No. 368-XXXX)

Material	5mm	7mm	9mm	10mm	12mm	20mm	25mm	30mm
Agate	0024	0025	0026		0027			
Sinter Alumina				0021	0022			
Zirconia					0096	0093		
Stainless Steel	0034	0035	0036		0037	0062		
Chrome Steel	0029	0030	0031		0032	0033		
Tungsten Carbide	0038	0039	0040		0041	0070		
Teflon w/Steel Core				0045	0046	0047		

## Vial Type for Mixer Mill Model 301 (Part No. 462-XXXX)

Material	1.5ml VV	5ml VV	10ml VV	25ml VV	35ml VV	50ml VV
	0.2-0.5ml SV	0.5-2ml SV	2-4ml SV	4-10ml SV	up to 15ml SV	up to 20ml SV
	1mm max PS	2mm max PS	4mm max PS	6mm max PS	6mm max PS	8mm max PS
	5mm BP	7mm BP	9,10,12mm BP	12, 20mm BP	20, 25mm BP	25, 30mm BP
Agate	0112	0113	0008			
Sinter Alumina	0110	0111	0007			
Stainless Steel	0057	0059	0061	0119		
Chrome Steel	0056	0058	0060	0052		
Tungsten Carbide	0114	0115	0009			
Teflon		0183	0184	0051		
Zirconia			0194	0195		
Agate Screw Top		0232	0233			
Stainless Steel Screw Top	0230	0231	0236	0213	0214	0216
Chrome Steel Screw Top				0237		
Teflon Screw Top				0238		
Tungsten Carbide Screw Top			0235	0217		
Zirconia Screw Top			0234	0201	0215	

VV - Vial Volume SV - Sample Volume PS - Particle Size BP - Ball Pestle

## Ball Pestle Type for Mixer Mill Model 301 (Part No. 368-XXXX)

Material	5mm	7mm	9mm	10mm	12mm	20mm	25mm	30mm
Agate	0024	0025	0026		0027			
Zirconia					0096	0093	0106	0092
Stainless Steel	0034	0035	0036		0037	0062	0105	0061
Chrome Steel	0029	0030	0031		0032	0033		
Tungsten Carbide	0038	0039	0040		0041	0070		
Teflon w/Steel Core				0045	0046	0047		



**CRYOGENIC GRINDING MILL**

The Cryogenic Grinding Mill chills and pulverize samples to liquid nitrogen temperatures. The sample vial (0.5 - 4ml capacity) is immersed in liquid nitrogen throughout the grinding cycle. The sample is stabilized at cryogenic temperatures and its key characteristics preserved. 50ml sample capacity vials are available for use with the larger 6850 cryogenic mill. Other features provide for speed control (2 - 30 impacts/second) and programmable grinding duration (0.1 - 100 minutes). The Standard Cryogenic Mill

is self-contained with a liquid nitrogen tub, insulated case, digital speed control, programmable timer and grinding vial set which includes 4 transparent polycarbonate cylinders (4ml capacity), 2 stainless steel end caps, one stainless steel impactor, an extractor/vial opener and vial rack. The mill measures 12" x 12.5" x 9" and weighs 12 lbs. Stainless steel cylinders are optional. The Expanded Cryogenic Mill is also self-contained with a liquid nitrogen tub, liquid nitrogen level sensor, insulated case, digital speed control, programmable timer and grinding vial set which includes 4 transparent polycarbonate cylinders (50ml capacity), 2 stainless steel end caps, one stainless steel impactor, an extractor/vial opener and vial rack. The mill measures 15.25" x 22" x 18.25" and weighs 105 lbs. A multi-vial adapter is optional when multi-vial grinding is preferred. The adapter will accommodate 4 transparent polycarbonate cylinders, each offering 4ml volume capacity. During operation, the smaller 6750 mill requires 5 liters of liquid nitrogen and the larger 6850 mill necessitates 10 liters for initial cool down. Additional coolant will be required depending upon the usage and the rate of evaporation. The 6750 mill typically uses 2 - 3 liters and the 6850 uses 4 - 5 liters per hour of operation after initial cool down and filling of tub. The 6850 features an option described as an auto-fill liquid nitrogen system as opposed to the manual fill design. The auto-fill system provides for an integrated sensor that indicates a low liquid nitrogen operating level which then opens a valve from the liquid nitrogen source thereby automatically filling the tub to adequate operating levels. When an adequate level is achieved the sensor signals the valve to close. This feature provides for convenience but more importantly contributes to safety and control.

- 6750-110 Standard Cryogenic Grinding Mill, 110V
- 6750-220 Standard Cryogenic Grinding Mill, 220V CE Approved
- 6850-110 Expanded Cryogenic Grinding Mill, 110V
- 6850-220 Expanded Cryogenic Grinding Mill, 220V CE Approved
- 6850-AFS Optional Auto-Fill Liquid Nitrogen System for 6850 Series Cryogenic Grinding Mill
- 6814-110 Optional Auto Extractor/Vial Opener, 110V
- 6814-220 Optional Auto Extractor/Vial Opener, 220V

**Vials and Accessories for Part No. 6750**

- 6751 Grinding Vial Set includes 4 transparent polycarbonate cylinders, 2 stainless steel end caps and one stainless steel impactor. Sample capacity 4ml.
- 6751C4 Transparent polycarbonate cylinders only. Sample capacity 4ml. 4 per pack.
- 6751C20 Transparent polycarbonate cylinders only. Sample capacity 4ml. 20 per pack.
- 6752 Stainless steel cylinder only. Sample capacity 4ml.
- 6751P Stainless steel impactor for Part No. 6751 and 6752. 2 per pack.
- 6751E Stainless steel end caps for Part No. 6751 and 6752. 2 per pack.

**Vials and Accessories for Part No. 6850**

- 6806 Multi-vial Adapter. Required when multi-vial grinding is preferred. Will accommodate (4) transparent 4ml polycarbonate cylinders. Refer to part numbers 6751, 6751E, 6751P and 6752.
- 6801 Grinding Vial Set includes (4) transparent 50ml polycarbonate cylinders, 2 stainless steel end caps and one stainless steel impactor.
- 6801C4 Transparent polycarbonate cylinders only. Sample capacity 50ml. 4 per pack.
- 6801C20 Transparent polycarbonate cylinders only. Sample capacity 50ml. 20 per pack.
- 38520 Stainless Steel end caps for Part No. 6801. 2 per pack.
- 38558 Stainless Steel impactor for Part No. 6801. 2 per pack.



**"WIG-L-BUG" GRINDING MILLS**

The Wig-L-Bug Grinding Mills are sample preparation accessories for solids that offer high speed pulverizing action. These devices eliminate the tedious and time consuming task of preparing samples with the use of agate mortars and pestles. The pulverizing action is reciprocating in the form of a figure eight. The ball pestle swings through a 6.5 degree arc at 3200 rpm and strikes the ends of the vial 2000 times in ten seconds. The rapid motion of the capsule and the fast mixing action of the ball pestle, permit samples to be ground more uniformly and reproducibly. The Model 3110-B is offered with a 60 second timer that provides for short one second intervals. Five second graduations assist with time settings. The Model 3110-3A is offered with a 30 minute timer and the minimum time setting is 60 seconds (thirty second graduations assist with time settings). The stainless steel vials and pestles are commonly used to avoid the risk of cross contamination if the sample preparation and the analysis of such samples is critical. Stainless steel and hardened steel is also chosen if the samples have mineral like characteristics. The agate vial is preferred for greater sample volume. All vials and ball pestles are reusable. Refer to the Digital Wig-L-Bug Grinding Mills below for variable speed programming and other novel features.

- 3110B Wig-L-Bug Grinding Mill with 60 second timer, 1" x 1/2" vial adapter and safety cover. Voltage: 110V
- 3110-3A Wig-L-Bug Grinding Mill with 30 minute timer and 1" x 1/2" vial adapter. Voltage: 110V
- 3113 Vial Adapter for 1" x 1/2" diameter vials
- 3119 Ball Pestle: clear plexiglas 1/8" diameter (100 units)
- 3112 Ball Pestle: clear plexiglas 3/8" diameter (100 units)
- 3114 Stainless Steel Vial 1" x 1/2" diameter with stainless steel ball pestle 1/4" diameter
- 3117 Hardened Steel Vial 1" x 1/2" diameter with hardened steel ball pestle 1/4" diameter
- 3125 Vial Adapter for 2" x 1/2" diameter vials
- 3116 Polystyrene Vial 2" x 1/2" diameter with polyethylene slip-on cap (100)
- 3118 Agate Vial 1 5/16" x 9/16" diameter with agate ball pestle 1/4" diameter (requires Vial Adapter, Part No. 3120)
- 3120 Agate Vial Adapter
- 33-108 Ball Pestle: Stainless Steel 1/4" diameter (10 units)
- 033-0200 Spare Long Arms
- 033-0205 Spare Short Arms
- 3110SC Safety Cover for older model 3110B Grinding Mills



3110MSD



3110LPD

- 3110MSD A digital grinding mill that includes keypad entry, 0 - 30 second timer, safety cover and variable speed programming (3800, 4200, 4600 and 4800 rpm) whose dimensions are 4 3/4" x 10 1/4" x 8". Voltage:110V. The mill requires a 5/8"Ø x 1 1/4" long polymeric vial and 1/4" stainless steel ball pestle.
- 3110LPD A digital grinding mill with a low profile feature which conveniently fits in laboratory drawers. Includes keypad entry, 0 - 30 second timer, safety cover and variable speed programming (3800, 4200, 4600 and 4800 rpm) whose dimensions are 11.5" x 8" x 4.5". Voltage:110V. The mill requires a 5/8"Ø x 1 1/4" long polymeric vial and 1/4" stainless steel ball pestle.
- 3111MSD Hard Black Polymeric Vial 1 1/4" x 5/8"Ø with stainless steel ball pestle 1/4"Ø for 3110MSD and 3110LPD mills. Sample capacity 2ml.
- 1501MSD Hard Black Polymeric Vial 1 1/4" x 5/8"Ø with stainless steel ball pestle 1/4"Ø for 3110MSD and 3110LPD mills. Set of 6 vials and stainless steel pestles. Sample capacity 2ml per vial.

**PLASMA CLEANER STERILIZER...PAGE 13**  
**LABORATORY PRESSES...PAGE 22**  
**PELLET DIES...PAGE 23**

**VARIABLE TEMPERATURE CELLS...PAGE 12**  
**DECOMPOSITION ACCESSORIES...PAGES 12, 13**



### HEATED TRANSMISSION CELL

Permits transmission mode measurement of solid and liquid samples up to 250°C. The cell has a low voltage heating system for safety and provides a protective water cooling system integrated within the standard slide-mount assembly to prevent heat transfer to the spectrometer. The cell is ideal for phase transition studies, temperature dependent absorption analysis, reaction kinetics, oxidation and polymerization studies. Sample cells are held in place by stainless steel retaining plates and quick release nuts.

20730 Heated Transmission Cell with electrically heated cell holder. Requires solid or liquid sample holder and temperature controller (see charts >>> for selection)



### -190° to 250°C VARIABLE TEMPERATURE CELL

Permits transmission mode measurement of solid and liquid samples with gas exchange capabilities across the face of a solid sample. The cell consists of a vacuum outer jacket and a cold finger that may be cooled with liquid refrigerant. Sample cells are inserted into the block attached to a cold finger fitted with heaters to maintain precise temperature control. The external vacuum jacket windows are heated to prevent condensation at sub-ambient temperatures. The liquid cell assembly can be converted to a flow-through configuration with the appropriate attachment. Two fixed thermocouples are installed to monitor the temperature of the cell holder and the outer jacket window assembly. A spare thermocouple can be introduced to accurately monitor the sample temperature. The cell can be configured for UV/VIS applications upon request.

21525 -190°C to 250°C Variable Temperature Cell includes cell holder, dewar, fixed thermocouples and low voltage supply cable. Requires external vacuum jacket windows, a solid or liquid sample holder and temperature controller (see charts >>> for selection)



### 500°C HIGH VACUUM SOLIDS CELL

Designed for analyzing solid and semi-solid samples under high vacuum and extreme temperature conditions. The vacuum body is equipped with (2) 32 x 3mm KBr outer jacket windows and operates up to 500°C with an integrated water cooling system. The complete assembly is fabricated from stainless steel and is thermally-insulated to inhibit heat loss. VCO fitted vacuum ports permit evacuating the cell down to 10<sup>-5</sup> torr. The sample cell retains (2) 25 x 2mm KBr windows which can be easily inserted or removed from the vacuum chamber. The temperature controller accompanying the cell, monitors and controls the sample temperature and vacuum chamber heaters simultaneously.

5775 High Vacuum, Heated Solids Cell with KBr sample cell, vacuum chamber, KBr outer-jacket windows and programmable/digital dual temperature controller



### HEATED CELL FOR SOLIDS, LIQUIDS AND GASES up to 250°C

The 10cm cell is an evacuable stainless steel chamber, heated by a low voltage heater surrounding the body. Cell temperature is measured with a thermocouple that passes through a vacuum-tight seal into the cavity. Samples are introduced through an injection septum using a syringe. Cell volume is approximately 113ml. Stainless steel flow tubes are

available for optional flow mode operation. The cell is perfect for gas analysis at elevated temperatures, vapor generated by solids and liquids at elevated temperatures and for performing decomposition studies.

5660 10cm Heated Cell of stainless steel construction with anodized aluminum end caps, silicon "O" rings and teflon gaskets, stainless steel flow tubes(2), injection adapter, thermocouple and cell mount. Requires windows and temperature controller (see charts >>> for selection)

Assemblies for -190 to 250°C Variable Temperature & 250°C Heated Transmission Cells							
Sample Holder	NaCl	KBr	CaF2	BaF2	ZnSe	ZnS	KRS-5
Sealed Liquid Cell with lead spacer*	20500	20501	20502	20503			
Demountable Liquid Cell with teflon spacer*	20510	20511	20512	20513			
Gas Exchange Solids Cell* with Gas Flow Kit	20620	20621	20622	20623			

\* Specify .025, .05, .1, .2, .5 or 1.0mm pathlength

### OPTIONS FOR -190 TO 250°C VARIABLE TEMP & HEATED TRANSMISSION CELLS

20600 Solids Holder for Heated Transmission Cell  
 20610 Solids Holder for Variable Temp. Cell  
 20650 13mm Disc Holder  
 20810 Liquid Flow-Through Kit

Replacement Windows (sold as a pair)							
Cell Type	NaCl	KBr	CaF2	BaF2	ZnSe	ZnS	KRS-5
Heated Liquid Transmission Cell up to 250°C	20520	20521	20522	20523	20596		
Variable Temperature Cell Outer Jacket Windows -190°C to 250°C	20800	20801	20802	20803	20896		
Variable Temp Liquid Cell -190°C to 250°C	20520	20521	20522	20523	20596		
Variable Temp Gas Exchange Solids Holder -190°C to 250°C	20633	20634	20635	20636	20642		
High Temp up to 500°C Solids Cell	5020	5021	5022	5023	5096		
10cm Heated Cell up to 250°C for Solids, Liquids and Gases	5020	5021	5022	5023	5096		

Temperature Controllers			
Cell Type	Heated Transmission Cell up to 250°C	VariableTemp Cell for Liquids & Solids -190°C to 250°C	10cm Heated Cell for Solids, Liquids & Gases to 250°C
Auto Temp Controller 110V with RS-232	20143	20426	20143
Auto Temp Controller 220V with RS-232	20142	20425	20142

### 500°C GAS CELL

This fixed pathlength 10cm stainless steel gas cell operates at temperatures up to 500°C. The cell body is isolated from the mounting plate by a thermal insulator and metal protective enclosure which prevents heat transfer within an instrument's sample compartment. Metal seals, dual band heater, type K thermocouple, stainless steel 1/4" Swagelok ports and programmable temperature controller with RS-232 computer interface accompany the cell. The cell can be configured for breadboard and FTIR instrumentation.



Cell designs with Viton seals rated at 200°C and Kalrez seals rated at 260°C are also available. Refer to page 8 for a choice of transmission materials and the back cover for a broad selection of gas cells.

5925 10cm Demountable High Temperature 500°C Gas Cell with 1/4" swagelok gas ports (2), metal seals, dual band heaters, type K thermocouple, protective ceramic/metal enclosure and Automatic Temperature Controller with RS-232 port for computer interface and programmable control feature to prevent thermal runaway.

## HIGH TEMPERATURE - HIGH PRESSURE LIQUID, SOLID, GAS CELL



An accessory designed for extreme condition spectroscopic analysis. Capable of providing temperatures up to 800°C and permitting a range of high pressures from vacuum to 1000psi. Configured to perform in transmission, specular reflectance or decomposition modes. The cell supports a 13mm disc assembly for transmission analysis. Specular reflectance can be performed with a simple interchange of the 13mm holder for a specular baseplate

assembly. The decomposition mode is attained by repositioning the 13mm holder to permit placement of the heated sample in a pan just below the optical beam... as gases evolve, the sample is analyzed. Constructed from corrosion resistant stainless steel, the cell is fitted with ZnSe outer jacket windows as standard. A high stability dual read-out RS-232 controller accompanies the accessory to accurately monitor sample and set point temperatures. The outer windows can be heated separately up to 200°C to prevent the condensation of evolved materials. Multiple inlet/outlet ports are incorporated in the design to allow for purging and easy mixing of gases for either continuous flow or static operation. The cell volume is 95ml. Its pathlength is 30mm. Built in safety features include a low voltage (30V) heating system, thermal switches to prevent overheating, a burst disc to prevent over pressurization, safety certified outer jacket windows, and water cooled top and bottom blocks to prevent heat transfer within the sample compartment while allowing the accessible surfaces of the accessory to maintain safe temperature. The cell is suitable for liquid vapor studies, process gas analysis, solid or solid-gas decomposition studies and general extreme condition high temperature/high pressure investigations.

- 5850 High Temperature - High Pressure Transmission and Decomposition Cell. Includes ZnSe windows & high stability temperature controller with RS-232 computer interface
- 5860 Specular Reflectance Upgrade
- 5855 Includes Part No. 5850 and Part No. 5860

## EXTRA VALUE SAMPLING KITS



- 0022-498 Economy Kit No. 1 for Liquid, Solid and Gas Sampling. Includes (2) PE Style 38.5 x 19.5 x 4mm demountable liquid cells, NaCl windows 38.5 x 19.5 x 4mm (4) drilled and (6) undrilled, 10cm demountable gas cell, (2) NaCl windows 25 x 4mm, KBr evacuable pellet press, beam attenuator, magnetic film holder, 65mm agate mortar and pestle, KBr powder 100gms, Nujol-2oz, and sturdy storage/carrying case
- 0022-499 Economy Kit No. 2 for Liquid, Solid and Gas Sampling. Same as Part No. 0022-498 but with KBr window material
- 0022-501 Economy Kit No. 3 for Liquid and Solid Sampling. Includes PE Style 38.5 x 19.5 x 4mm demountable liquid cell, (1) KBr window 38.5 x 19.5 x 4mm drilled and undrilled, 25mm demountable cell holder, (4) KBr windows 25 x 4mm, KBr pellet press, KBr powder-100gms, Nujol-4oz, Fluorolube-1oz, 35mm agate mortar and pestle, 8" spatula, magnetic film holder, (1) IR Quartz cuvette-10mm Type 1, cuvette holder-10mm, and sturdy storage/carrying case
- 0022-500 Economy Kit No. 4 for Liquid and Solid Sampling. Includes KBr quick hand press with 1, 3, and 7mm die sets, pellet holder, PE Style 38.5 x 19.5 x 4mm demountable liquid cell, KBr windows 38.5 x 19.5 x 4mm (2) drilled and (2) undrilled, 25mm demountable cell holder, (4) KBr windows 25 x 4mm, (2) BaF2 windows 25 x 4mm, magnetic film holder, 35mm agate mortar and pestle, KBr powder-100gms, Nujol-4oz, Fluorolube-1oz, and sturdy storage/carrying case
- 0022-502 Economy Kit No. 5 offers a selection from any one of the economy kits above and permits substituting the standard transmission material with a preferred material.



RGD-100



DGVK

## PLASMA CLEANER

A radio-frequency glow discharge accessory (RGD) whose primary purpose serves as a spectroscopic tool for cleaning transmission cells, windows, microscope slides and internal reflection elements but has also been ideal for sterilizing surgical components and implants in the medical and dental professions. Other applications include sample preparation for electron microscopy, the treatment of polymer surfaces to improve adhesion, the removal of photoresist on semiconductor wafers, and surface preparation prior to vacuum film evaporation in the coating industry. Typically, residue considered to be organic contaminants, can become trapped in small margins and retentive voids as a result of hydrophobic areas on sampling or prosthetic surfaces. In cases of medical and dental implants, lack of attention to the surface energy and cleanliness may compromise the initial phases of tissue healing after implantation. This accessory removes residue and strongly bound hydrocarbon layers thereby preventing cross contamination and improving wettability, bioadhesiveness and biologic compatibility. The RGD is a compact electrodeless device that utilizes radio-frequency to excite an Argon, Nitrogen, Oxygen or air gas which creates a plasma (use of Oxygen requires an Oxygen compatible vacuum pump). The plasma created is a partially ionized complex gas composed of electrons, ions, free radicals, photons of various energies and gas atoms. The glow discharge or plasma produces an energized gas flow that modifies the physicochemical characteristics of solid surfaces without affecting the underlying bulk properties of the material. A few seconds exposure is often adequate to clean the surface. Two models are available. The RGD-100 series offers a 3" diameter by 7" long chamber, overall measures 8" (H) x 10" (W) x 8" (D) and weighs 12 lbs. The RGD-200 series is assembled with a 6" diameter by 6" long chamber, measures 11" (H) x 18" (W) x 9" (D) and weighs 45 lbs. Each model includes a 1/8" NPT needle valve, Pyrex chamber and an adjustable radio-frequency power setting. Options include 110V or 220V operation, 0.1 torr vacuum pump, quartz chambers, flow meter and thermocouple vacuum gauge. The Dual Gas Vacuum Flow Kit is a stand alone unit used with the Plasma Cleaner. It provides the ability to mix two gases if desired. The gas flow rate 0 - 20 SCFM can be regulated and monitored. The kit also includes a 0-2000 mTorr vacuum gauge to accurately monitor vacuum conditions and assist with diagnosing vacuum problems.

RGD-100 Series Power Rating			
RF Setting	Volts DC	milli-Amps	Watts
Low	680	10	6.8
Medium	700	15	10.5
High	720	25	18
RGD-200 Series Power Rating			
RF Setting	Volts DC	milli-Amps	Watts
Low	716	10	7.16
Medium	725	14	10.15
High	740	40	29.6

- 110RGD-100 Radio-Frequency Glow Discharge Plasma Cleaner. Includes cooling fan, 1/8" NPT needle valve, adjustable RF power setting and 3" x 7" Pyrex chamber. Voltage: 110V
- 220RGD-100 Radio-Frequency Glow Discharge Plasma Cleaner. Includes cooling fan, 1/8" NPT needle valve, adjustable RF power setting and 3" x 7" Pyrex chamber. Voltage: 220V
- 110RGD-200 Radio-Frequency Glow Discharge Plasma Cleaner. Includes cooling fan, 1/8" NPT needle valve, adjustable RF power setting and 6" x 6" Pyrex chamber. Voltage: 110V
- 220RGD-200 Radio-Frequency Glow Discharge Plasma Cleaner. Includes cooling fan, 1/8" NPT needle valve, adjustable RF power setting and 6" x 6" Pyrex chamber. Voltage: 220V
- RGD-110V 110V Vacuum Pump, 100 milli-torr
- RGD-220V 220V Vacuum Pump, 100 milli-torr
- RGD-110V-OXY 110V Oxygen compatible Vacuum Pump, 100 milli-torr
- RGD-220V-OXY 220V Oxygen compatible Vacuum Pump, 100 milli-torr
- DGVK-110V 110V Dual Gas Vacuum Flow Kit
- DGVK-220V 220V Dual Gas Vacuum Flow Kit
- RGD-100Q Quartz Chamber for RGD-100 series Plasma Cleaners
- RGD-200Q Quartz Chamber for RGD-200 series Plasma Cleaners

**SINGLE REFLECTION DIAMOND ATR**

High pressure (up to 3 kilobars) system is ideal for applications with highly absorbing samples, polymer pellets, hard or opaque solids, single fibers and microscopic particles, corrosive liquids and for analysis of most samples normally requiring the use of an FTIR microscope or high pressure diamond anvil cell. The unit comes with a 2 x 2mm 45° single reflection

Type IIa Diamond brazed within a Tungsten Carbide sample mount. The optical path directs the infrared energy to an active sample area of 0.6mm in diameter. The accessory includes a novel swing bridge with a mounted Sapphire anvil for high pressure contact. The anvil has a clear working distance of 6mm for macro samples and is mounted into a non-rotating clamp to avoid sample shear and heating by friction. A volatiles cover, flexible bellows for purge maintenance and torque wrench for reproducible results also accompany the accessory.

2000 Single Reflection Diamond ATR includes optical unit with type IIa diamond, tungsten carbide sample mount, flat sapphire anvil, concave polymer anvil, volatiles cover, purge tubes and torque wrench

2001 Same as Part No. 2000 but with 200°C heated top plate and programmable temperature controller

2005 Optional 45° Germanium top plate for Part No. 2000

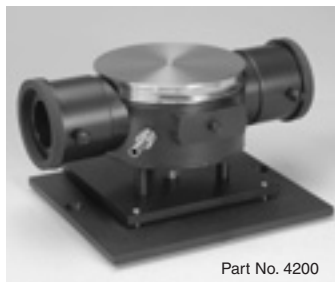

Part No. 4200



Part No. 4201

**MicroQC**

The MicroQC is an economical solution for quality control offering quick and easy analysis of small samples requiring little or no sample preparation. This in compartment accessory is an engineered concept whose optical configuration integrates multiple reflection ATR and 75° grazing angle specular top plate assemblies. The three mirror design incorporates a highly reflective parabolic mirror providing for outstanding infrared energy collection efficiency. The accessory is pre-aligned even when interchanging top plates and features systematic purge maintenance. The multiple reflection top plate assembly is comprised of ZnSe and Silicon elements. ZnSe serves as the IR transmitting-focusing element whilst the Silicon element establishes the 4mm diameter active area for sample interface. Its unique optical format offers an impressive 14 reflections achieving high sensitivity even for highly diluted samples. The standard top plates perform in the spectrum from approximately 1 - 15 microns. The top plate is suitable for micro sampling liquids, powders, pastes and other semi-solid materials. An optional top plate assembled with Diamond is available for analytical investigations which are not compatible with Silicon. The specular reflection top plate is assembled with a built-in Silicon polarizer to induce high spectral contrast and increase sensitivity. The top plate is suitable for analysis of surface coatings on reflecting substrates; film thickness measurements by interference fringes and reflectivity coefficient determinations of metals. It provides for 3mm active sample area. The 75° grazing angle is appropriate for measuring thin films in the nanometer thickness range.

4200 MicroQC with ZnSe-Silicon Multiple Reflection ATR Top Plate

4201 MicroQC with Specular Reflection Top Plate

4208 ZnSe-Silicon Multiple Reflection ATR Top Plate Only

4209 Specular Reflection Top Plate Only

**High Throughput ATR MICROSAMPLER**

The accessory employs a Silicon internal reflection element achieving optimal contact within a small sampling area - less than 0.2mm in diameter. A calibrated pressure applicator is inherent for reproducible results. The unit permits uninterrupted purge when exchanging samples. A 50X microscope is available for easy viewing of sampling area. It remains uniquely suitable for forensic analysis; studying thick, hard-surfaced samples; slightly curved samples; fibers; paints; nanoliters of liquids pastes; and most corrosive liquids.

4000 ATR Microsampler with baseplate, two internal reflection sample holders with mounted silicon hemispheres, sample holder for analyzing powders and 50X microscope

4001 ATR Microsampler with baseplate, two internal reflection sample holders with mounted silicon hemispheres, sample holder for analyzing powders without 50X microscope

4002 50X microscope upgrade

4003 Spare Silicon mounted ATR cartridge

**Single Reflection ATR**

This is a high value, low cost, pre-aligned single reflection ATR accessory. When compared to more expensive single reflection designs, its sensitivity is equally impressive for qualitative and quantitative analysis. The unique 45° ZnSe internal reflection element, combined with the two mirror assembly for beam entry to the sample and return to the instrument's detector, provides for minimal energy loss and records an average 85 percent open beam throughput. Other design features include the ability to easily remove and clean or replace the ATR crystal from its mechanical mount assembled with the flat or trough top plate. This convenience permits interchange between other ATR crystals without having to purchase complete top plate assemblies. A kalrez gasket incorporates an assured seal for the top plates and eliminates problems associated with designs using epoxy. The gasket does not interact with the sampling radiation, thus spectra are free from spurious peaks or energy degradation. Additional options include a ZnSe trough top plate, heated solid and liquid top plates, liquid flow-through cell and spare 45° ZnSe, Ge or ZnS prisms.



8000



8001

free from spurious peaks or energy degradation. Additional options include a ZnSe trough top plate, heated solid and liquid top plates, liquid flow-through cell and spare 45° ZnSe, Ge or ZnS prisms.

8000 Single Reflection ATR accessory with a 45° ZnSe flat top plate, pressure clamp, volatiles cover and flexible tubes for purge maintenance

8001 250°C High Temperature, 800psi High Pressure Single Reflection ATR accessory with 45° ZnSe top plate and temperature controller

8005 ZnSe Trough Top Plate

8006 Liquid Flow Through Cell

8007 0-200°C ZnSe Flow Through Cell with Temperature Controller

8008 ZnSe ATR Crystal

8009 Ge ATR Crystal

8010 ZnS ATR Crystal



Part No. 2800



Part No. 2825

**R-T MultiSampler**

An out-of-compartment autosampling accessory. The accessory can be used in reflectance or transmission modes. The semiconductor industry has determined the MultiSampler's reflectance capability a comprehensive solution in semiconductor wafer characterization. The device is also ideal for characterizing non-semiconduc-

tor materials such as films and coatings on reflective substrates. In transmission mode, the system is designed for a wide range of samples including films, slides, pellets, windows and large area samples. The sampling plate can be configured for any combination of sample number, type and geometry. Sample diameters up to 8" can be accommodated in a demountable spring-loaded, delrin mechanism. The use of linear translation and rotational motor drives are managed by a motion control unit with integrated programmable software. This offers analysis of any sequence of points on the sample and controls spectral data acquisition. Sophisticated test sequences can be easily designed, implemented and stored as method with full flexibility. The transmission-only version is available with 6" Ø sample capacity.

2800 MultiSampler for Automated Reflectance and Transmission with 8" diameter sample capacity, programmable control unit and software.

2825 Automated Transmission Sampler with standard 32 position multisample mount, programmable control unit and software

2801 Standard insert (2", 3", 4", 5" or 6" diameters) for Part No. 2800

**HORIZONTAL ATR**

This is a multiple reflection, high throughput in-compartment FTIR accessory optimized for routine use. Its optical design eliminates the need for frequent alignment. The top plates are easily removed for quick cleaning and may be readily interchanged. The pinned top plate mounting ensures repeatable positional accuracy, providing convenience and analytical precision.

Complete trough, flat-plate and combined configurations are offered. Also available are flow-through and temperature regulated top plates. Both baseplate and slide-mounted versions are provided with a purge kit.

- 1000 HATR Trough Plate System includes ZnSe 45° trough top plate, volatiles cover and powder press
- 1050 HATR Flat Plate System includes ZnSe 45° flat top plate and flat plate clamp
- 1075 HATR Combined Trough and Flat Plate System includes ZnSe 45° flat and trough top plates, flat plate clamp, volatiles cover and powder press
- 1001 ZnSe 45° Flat(F) or Trough(T) Top Plate
- 1002 ZnS 45° Flat(F) or Trough(T) Top Plate
- 1003 Ge 45° Flat(F) or Trough(T) Top Plate
- 1004 Si 45° Flat(F) or Trough(T) Top Plate
- 1005 KRS-5 45° Flat(F) or Trough(T) Top Plate
- 1006 AMTIR 45° Flat(F) or Trough(T) Top Plate
- 1007 CdTe 45° Flat(F) or Trough(T) Top Plate
- TBA 30° and 60° Top Plates available upon request
- 1008 Flat Top Plate Clamp Mechanism
- 5008S Flat Top Plate Super Clamp Mechanism
- 1009 Volatiles Cover
- 1010 Powder Press
- 1011 100ul ZnSe 45° ATR Flow-Through Top Plate
- 1012 500ul ZnSe 45° ATR Flow-Through Top Plate
- 1013 100ul KRS-5 45° ATR Flow-Through Top Plate
- 1014 500ul KRS-5 45° ATR Flow-Through Top Plate
- TBA Other ATR materials with 30° or 60° Flow-Through Top Plates available upon request
- 1018 Heated ATR System up to 100°C includes 45° ZnSe Trough Top Plate, Auto-Temp Controller and Control Software
- 1015 ZnSe 45° Electrically Heated Trough Top Plate
- 1016 KRS-5 45° Electrically Heated Trough Top Plate
- 1017 Ge 45° Electrically Heated Trough Top Plate
- TBA Other ATR materials with 30° or 60° Heated Trough Top Plates available upon request

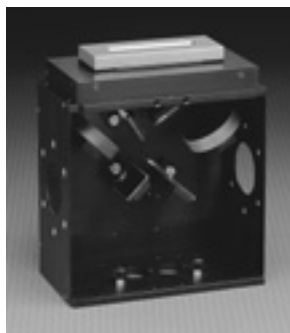
**HORIZONTAL ATR**

An out-of-compartment accessory offers an external sampling surface above the instrument's sample compartment providing maximum versatility for the analysis of liquids, pastes, gels, films and powders, while maintaining system purge. The system purge is maintained even during top plate changeover. The pinned top plate mounting ensures repeatable positional accuracy thereby eliminating the need for frequent alignment. The efficient optical design is exceptionally stable, permitting high energy throughput from analysis to analysis.

- 1200 HATR Trough Plate System including sealed purge configuration, ZnSe 45° trough top plate, volatiles cover and powder press
- 1250 HATR Flat Plate System including sealed purge configuration, ZnSe 45° flat top plate and flat plate clamp
- 1275 HATR Combined Trough and Flat Plate System including sealed purge configuration, ZnSe 45° flat and trough top plates, flat plate clamp, volatiles cover and powder press

See Series 1000 above and select additional top plates.



Part No. 5008S

**VARIABLE ANGLE HORIZONTAL ATR**

A unique accessory permitting variable angle ATR spectroscopy over a range of incident angles from 20° to 70°. With the use of a flat or trough top plate, optical alignment is maintained at all angles of incidence. Using the precision angle adjustment, the angle of incidence can be increased or decreased depending upon the sensitivity requirements of the solid or liquid sample. As the angle of incidence changes the number of infrared reflections, depth of penetration and absorbance intensity... the angle is selected to optimize sensitivity. Measured absorbance is directly related to the depth of penetration controlled by the angle of incidence. An automated version offers high performance and conveniently selects incidence angles that are programmed independently or simultaneously. Software is integrated to control motion and data acquisition. A Super Clamp with micrometer adjustment and vernier scale is optional for critical clamping requirements and reproducibility. A purge kit is standard for all variable angle HATR systems.

- 5000 Variable Angle Horizontal ATR Trough Plate System includes ZnSe 45° trough top plate, volatiles cover and powder press
- 5050 Variable Angle Horizontal ATR Flat Plate System includes ZnSe 45° flat top plate and flat plate clamp
- 5075 Variable Angle Horizontal ATR Combined Trough and Flat Plate System includes ZnSe 45° flat and trough top plates, flat plate clamp, volatiles cover and powder press
- 5090 Automated Variable Angle Horizontal ATR adds optional software and motion control to any of the above three configurations. Includes programmable control unit and software
- 5001 KRS-5 45° Flat(F) or Trough(T) Top Plate
- 5002 ZnSe 45° Flat(F) or Trough(T) Top Plate
- 5003 ZnS 45° Flat(F) or Trough(T) Top Plate
- 5004 Ge 45° Flat(F) or Trough(T) Top Plate
- 5005 Si 45° Flat(F) or Trough(T) Top Plate
- 5006 AMTIR 45° Flat(F) or Trough(T) Top Plate
- 5007 CdTe 45° Flat(F) or Trough(T) Top Plate
- TBA 30° Top Plates available upon request
- 5008 Flat Top Plate Clamp Mechanism
- 5008S Flat Top Plate Super Clamp Mechanism
- 5009 Volatiles Cover
- 5010 Powder Press

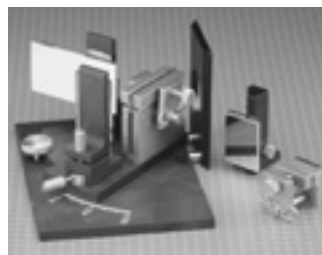
**VARIABLE ANGLE VERTICAL ATR**

A high performance in-compartment ATR accessory offering precision angle alignment from 30° to 60°. Angle adjustments are simple and reproducible. The VATR is ideal for analysis of solids, films and coatings. Supplied with demountable stainless steel clamps for easy sample introduction and removal. A standard 50 x 10 x 3mm KRS-5 45° crystal accompanies the unit.

- 1500 VATR includes 50 x 10 x 3mm KRS-5 45° ATR crystal, demountable 50 x 10 x 3mm and 25 x 10 x 3mm stainless steel clamps and alignment mirror for the 25mm ATR crystal format
- 27-16 Optional 25 x 10 x 3mm KRS-5 45° ATR crystal

**PLASMA CLEANER FOR ATR CRYSTALS AND TOP PLATES...PAGE 13**  
**EXTREME CONDITION REFLECTANCE ACCESSORIES...PAGES 14, 15, 16**  
**SPECULAR AND DIFFUSE REFLECTANCE ACCESSORIES...PAGES 16, 17**  
**ATR REPLACEMENT CRYSTALS...PAGE 18**  
**SPECTRA-TECH ATR TOP PLATES...PAGE 19**

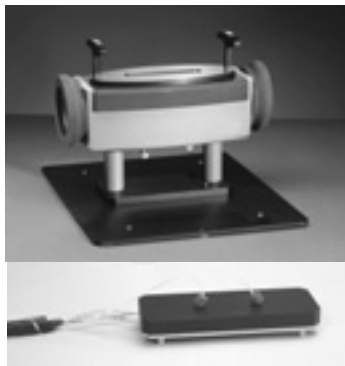
**HIGH TEMPERATURE /PRESSURE HATR**

Developed for reflectance analysis at extreme conditions. Its engineering offers performance at temperatures up to 200°C and pressures to 500psi. A flow cell design with a 65µl volume permits analysis of aqueous and non-aqueous samples. A leakproof Kalrez O-ring seal is assured even under the maximum pressurized conditions. All top plates are Teflon coated for enhanced chemical resistivity and their pinned mounting permits top plate interchange for reproducible results. The accessory's low volume, fully purged optical cavity ensures optimum sampling

conditions. Its baseplate mount configuration offers stable optical alignment. A dual controller accompanies the accessory to independently regulate and monitor sample and top plate temperatures. Standard flat and trough plate assemblies are available for ambient analysis (see chart on page 19 for selection of top plates and replacement crystals).

- 2500 High Temperature-High Pressure HATR includes a purgeable optical system, electrically heated flow cell with 45° ZnSe crystal, temperature controller, 1/16" o.d. teflon tubing and fittings
- 2510 High Pressure HATR includes a purgeable optical system, flow cell with 45° ZnSe crystal, 1/16" o.d. teflon tubing and fittings
- TBA Other ATR materials & incident angles available upon request.
- TBA Other fittings such as Swagelok, 1/8" o.d. tubing and other tubing materials are available upon request.

**DUAL REFLECTANCE SAMPLING SYSTEM**

A versatile accessory that combines two reflectance techniques. Its single base mounted optical design permits a configuration for either Horizontal ATR or Diffuse Reflectance analysis. This fully purged, pre-aligned system provides reproducible results even when interchanging reflectance techniques. The HATR trough plate is ideal for liquids, gels, pastes and powders. The flat plate with a clamp device is provided for analyzing polymer films, rubbers and other solid samples. All top plates are Teflon coated for enhanced chemical resistivity and their pinned mounting permits top plate changeover for accurate positioning. To analyze any intractable or diffusely scattering samples, the HATR sampling plate is simply removed and the diffuse reflectance interface is installed on top of the base unit. The diffuse sample wheel offers six positions for retaining macro or micro sampling cups. Typically, one of the positions serves as a background reference and the wheel is manually rotated to the next graduated position for sample analysis. The wheel can easily be removed from the accessory for reloading without losing systematic purge. For greater flexibility, see the optional configurations below and top plate selection on page 19.

- 9500 Dual Reflectance Sampling System includes a base-mounted, purgeable optical unit with 45° ZnSe flat and trough plates, flat plate clamp, volatiles cover, diffuse sampling interface, diffuse sample wheel, six macro cups, alignment mirror and KBr powder
- 9510 Dual Reflectance Sampling System includes a base-mounted, purgeable optical unit with 45° ZnSe flat plate, flat plate clamp, diffuse sampling interface, diffuse sample wheel, six macro cups, alignment mirror and KBr powder
- 9520 Dual Reflectance Sampling System includes a base-mounted, purgeable optical unit with 45° ZnSe trough plate, volatiles cover, diffuse sampling interface, diffuse sample wheel, six macro cups, alignment mirror and KBr powder
- 9501 Flat Top Plate Clamp Mechanism
- 6001 Optional Abrasion Sampling Kit including 75 SiC and 25 Diamond abrasive pads, metal stud and chuck
- 9502 Macro Sampling Cup, volume 0.3 grams
- 9503 Micro Sampling Cup, volume 0.01 grams
- 9504 Sample funnel for micro cup
- 9505 Spare Diffuse Sample Wheel - six positions

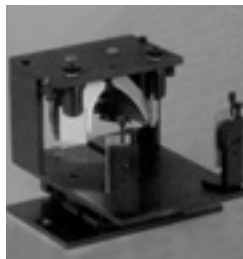
**DIFFUSE REFLECTANCE REACTION CHAMBERS**

This accessory meets the need for demanding Diffuse applications which require in-situ measurements of materials under varying environmental and reaction conditions. By exposing these materials to simulated reaction conditions, in-situ models can be created to predict performance. Investigations such as the analysis of samples exposed to inert gases, dehydration kinetics, cryogenics, adsorbate characterization, catalysis studies, solid-solid phase transitions, thermal degradation studies, zeolite analysis, sample reactions in hazardous environments and the general analysis of samples under non-ambient conditions can all be performed using a specific chamber. The chambers have been engineered to permit analysis of samples under a range of vacuum, pressure and temperature conditions. The accessory's optical design provides high energy throughput for nanogram levels of sensitivity.



- 6500 High Temperature-High Pressure Chamber heats to 900°C and pressurizes to 1500psi. Includes the base-mounted optical unit, reaction chamber, ZnSe hemisphere, alignment mirror and temperature controller
- 6510 High Temperature-High Pressure Chamber heats to 600°C and pressurizes to 500psi. Includes the base-mounted optical unit, reaction chamber, ZnS hemisphere, alignment mirror and temperature controller
- 6520 High Temperature-High Vacuum Chamber heats to 900°C with vacuum conditions from 10<sup>-5</sup> torr to ambient. Includes the base-mounted optical unit, reaction chamber, dome with KBr windows(2), alignment mirror and temperature controller
- 6530 High Temperature-High Vacuum Chamber heats to 500°C with vacuum conditions from 10<sup>-5</sup> torr to ambient. Includes the base-mounted optical unit, reaction chamber, dome with KBr windows(2), alignment mirror and temperature controller
- 6540 Low Temperature-High Vacuum Chamber operates at -150 to 600°C and at vacuum conditions from 10<sup>-5</sup> torr to ambient. Includes the base-mounted optical unit, reaction chamber, ZnS hemisphere, alignment mirror and temperature controller

**R-T MULTISAMPLER AUTO-12 SERIES**

The AUTO-12 has been proven ideal for semiconductor wafer characterization; particularly the determination of epitaxial layer thickness (EPI), and measurements of Borophosphosilicate Glass (BPSG) and carbon-oxygen. This Series has been developed in response to the semiconductor industry need for an accessory capable of handling 12 inch diameter wafers. It incorporates all of the features of the R-T MultiSampler (as described on page 14) with added expansion for inserts to support 2 - 8 inch diameter wafers. The AUTO-12 is a complete hardware and software package for automated, multi-position data collection and processing. The software accompanying the AUTO-12 interfaces easily with all Windows™ based programs via DDE links and seamlessly integrates with the spectrometer's software. The sample stage of this accessory is driven by stepper motors with approximate resolution of 12 steps/mm in the linear direction and 8 steps/degree in the angular direction. To offer an understanding of the software's accuracy, an instrument with an 8mm beam diameter can measure up to 320 points on a 12 inch wafer with a 5mm setting for wafer edge exclusion. Another added development of the AUTO-12 is a full purge feature. Simple connection to the purge fitting and a source of dry air or nitrogen, minimizes the interference of water vapor and CO<sub>2</sub> normally associated with infrared measurements. Refer to the R-T MultiSampler on page 14 for more information.

- 2810 AUTO-12 for Automated Reflectance and Transmission with 12" diameter sample capacity, programmable control unit and software
- 2803 Spare 12" wafer mount
- 2804 Standard insert (2", 3", 4", 5", 6" or 8" diameters) for Part No. 2810

**ATR REFLECTANCE ACCESSORIES.....PAGES 14, 15, 16**  
**SPECULAR AND DIFFUSE REFLECTANCE ACCESSORIES..PAGES 16, 17**  
**ATR PRISMS, RODS AND RECONDITIONING.....PAGE 18**  
**ATR FLAT AND TROUGH TOP PLATE RECONDITIONING.....PAGE 19**





**SPECULAR REFLECTANCE** is a technique for analyzing transparent films which usually yield weak spectra by ordinary transmission techniques. Applications include analysis of surface coatings on reflecting substrates; film thickness measurements by interference fringes and reflectivity coefficient determinations of metals. The application is the determining factor when deciding which angle of incidence should be selected. A 30° angle of incidence is normally chosen for more routine samples which have coatings in the micrometer range. For very thin coatings in the nanometer thickness range, an 80° angle of incidence would be appropriate. When sample thickness is unknown, the full range of specular reflectance analysis can be performed conveniently with the Variable Angle 30° to 85° accessory. Simply move the sliding lever on the graduated scale to the desired angle. Each accessory provides a reference mirror to permit the operator to acquire a background spectrum. Their design eliminates stray light and ensures minimum energy loss. Sensitivity can be further enhanced with the use of a wire grid polarizer.

- 7210 12.5° Specular Reflectance Accessory & sample mask set
- 7200 30° Specular Reflectance Accessory & sample mask set
- 7201 80° Specular Reflectance Accessory
- 7202 Variable Angle 30° - 85° Specular Reflectance Accessory with mask set
- 7203 Automated Variable Angle 30° to 85° Specular Reflectance Accessory with software and motion control. Selection of incidence angle sequences can be programmed independently or simultaneously. Includes Part No. 7202, programmable control unit and software
- 7204 Automated Variable Angle 30° to 85° Specular Reflectance Accessory with Automated Polarizer offers software and motion control permitting programmable selection of incident angle and polarization angle sequences either independently or simultaneously. Includes Part No. 7202, motorized polarizer mount, ZnSe wire grid polarizer, programmable control unit and software
- 7205 As Part No. 7204 but with KRS-5 wire grid polarizer

**NEAR AND MID-INFRARED POLARIZERS**

Material	KRS-5	Ge	CaF2	BaF2	ZnSe
Spectral Range	2 - 35µm	8 - 14µm	1 - 9µm	1 - 12µm	1 - 14µm
Grid Spacing	.25µm	.40µm	.25µm	.25µm	.25µm
Transmission	74% @ 10µm	90% @ 10.6µm	85%	85%	75% @ 2.5µm
Efficiency (K1)	70% @ 3µm				70% @ 10µm
Transmission of Unwanted Polarization	.25% @ 10µm 1.5% @ 3µm	.25% @ 10µm	1% @ 3µm 3% @ 1.5µm	1% @ 3µm 3% @ 1.5µm	2.8% @ 2.5µm 1% @ 10µm
Degree of Polarization	99% @ 10µm 95% @ 3µm	99% @ 10.6µm 93% @ 1.5µm	98% @ 3-9µm 93% @ 1.5µm	98% @ 3-11µm 93% @ 1.5µm	97% @ 10µm 93% @ 2.5µm
Extinction Ratio*	148:1 @ 10µm 23:1 @ 3µm	180:1 @ 10.6µm 30:1 @ 2.5µm	170:1 @ 7µm 42:1 @ 3µm	200:1 @ 10µm 42:1 @ 3µm	140:1 @ 10µm 17:1 @ 2.5µm
29mm Ø Ring Mounted	12000M	12700M	12800M	12900M	12950M
29mm Ø Unmounted	12000UM	12700UM	12800UM	12900UM	12950UM
29mm Ø Rotary Mounted	12000RM	12700RM	12800RM	12900RM	12950RM
25mm Ø Ring Mounted	13000M	13700M	13800M	13900M	13950M
25mm Ø Unmounted	13000UM	13700UM	13800UM	13900UM	13950UM
38mm Ø Ring Mounted	14000M	14700M	14800M	14900M	14950M
38mm Ø Unmounted	14000UM	14700UM	14800UM	14900UM	14950UM
50mm Ø Ring Mounted	15000M	15700M	15800M	15900M	15950M
50mm Ø Unmounted	15000UM	15700UM	15800UM	15900UM	15950UM
75mm Ø Ring Mounted	16000M	16700M	16800M	16900M	16950M
75mm Ø Unmounted	16000UM	16700UM	16800UM	16900UM	16950UM

Polyethylene and Polyester Polarizers available upon request  
\*Higher Extinction Ratio Polarizers available upon request



The High Throughput **DIFFUSE REFLECTANCE ACCESSORY** is a compact, high performance device that provides outstanding collection efficiency through the incorporation of a large ellipsoidal reflector. The diffuse reflectance technique is applicable to powders, foams, fibers, coal, paper, paints, plastics, polymer coatings and many other samples where conventional analytical techniques are difficult or impossible to use. The High Throughput Diffuse Reflectance Accessory is easy to use with its permanently aligned reflector and dual position sample holder permitting background collection without readjustment or refocusing. An automated version is available for demanding applications. The Auto-Diffuse software manages the analysis of any sequence of samples up to 60 positions and controls data acquisition. The flexible sample sequencing includes interrupt and background collection. An integrated solution for enhanced laboratory productivity.

- 6000 High Throughput Diffuse Reflectance Accessory complete with 2 micro and 2 macro sampling cups, KBr powder, sample funnel, shuttle for sample cups, 35mm agate mortar/pestle, 2 spatulas and camel hair brush
- 6001 Optional Abrasion Sampling Kit including 75 SiC and 25 Diamond abrasive pads, metal stud and chuck
- 6010 Automated Diffuse Reflectance System includes programmable control unit and software, 60 position sample mounting tray, 60 sample cups and sample preparation system

**EXTRA VALUE REFLECTANCE PACKAGE**

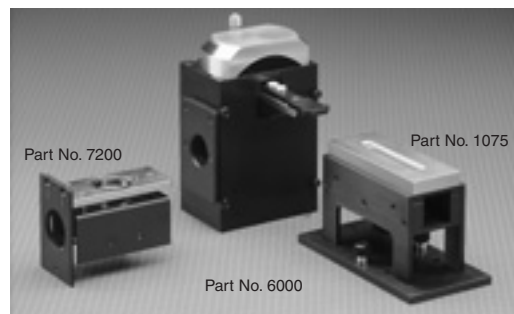

- 9000 Includes HATR Part No.1075, Diffuse Part No. 6000 and Specular Part No. 7200

**360° POLARIZER ROTATORS**

Each rotator is assembled with a 3" x 2" backplate which can be placed within an FTIR instrument's sample compartment slide mount. They feature a 5° graduated scale and 360° rotation. The rotators are fabricated from stainless steel and black anodized hardware. The designs accepts 29mm Ø x 2mm thick polarizer substrates housed within a 25mm clear aperture mounting ring which is included with the rotator. The removable polarizer mounting ring permits easy and convenient interchange among the various polarizer materials offered by REFLEX Analytical. An accessory case is supplied for safe transport and storage. The Universal 360° Polarizer Rotator is also assembled with a 3" x 2" backplate and base tapped holes for breadboard or optical bench mounting. To accommodate breadboard and optical bench mounting, a 120mm post is supplied. The design also incorporates a positive lock mechanism to ensure an accurate position until released. The Crossed Polarizer Rotator is a design which is similar to the Universal 360° Polarizer Rotator although features the ability to attached a second polarizer for crossed polarization requirements. A crossed polarized configuration achieves high contrast thereby providing for higher extinction ratios. The assembly permits inserting one polarizer within the rotary mount while the second polarizer is located and secured over the first. Each polarizer can be rotated 360° independent of the other. A lens, beam-splitter or filter could be used in place of the second polarizer. Mounted and unmounted 29mm diameter polarizers can be purchased separately. See adjacent schedule for additional polarizer diameters and configurations.

- 12600 FTIR 360° Polarizer Rotator
- 12700 Universal 360° Polarizer Rotator
- 12700CPR Crossed Polarizer 360° Rotator
- 12500 360° Polarizer Rotator for 3" x 2" slide mount accessories

## NEW POLISHED ATR PARALLELOGRAM/TRAPEZOID PRISMS AND RODS

Parallelogram	AMTIR	CdTe	Ge	KRS-5	Si	ZnS	ZnSe	Trapezoid	AMTIR	CdTe	Ge	KRS-5	Si	ZnS	ZnSe
10x5x3Para30dg	24-01	25-01	26-01	27-01	28-01	29-01	30-01	12x5x1Trap45dg	31-01	32-01	33-01	34-01	35-01	36-01	37-01
10x5x5Para45dg	24-02	25-02	26-02	27-02	28-02	29-02	30-02	12x5x1Trap60dg	31-02	32-02	33-02	34-02	35-02	36-02	37-02
10x5x3Para60dg	24-03	25-03	26-03	27-03	28-03	29-03	30-03	12x5x2Trap45dg	31-03	32-03	33-03	34-03	35-03	36-03	37-03
10x5x1Para30dg	24-04	25-04	26-04	27-04	28-04	29-04	30-04	12x5x2Trap60dg	31-04	32-04	33-04	34-04	35-04	36-04	37-04
10x5x1Para45dg	24-05	25-05	26-05	27-05	28-05	29-05	30-05	50x5x2Trap45dg	31-05	32-05	33-05	34-05	35-05	36-05	37-05
10x5x1Para60dg	24-06	25-06	26-06	27-06	28-06	29-06	30-06	50x5x3Trap45dg	31-06	32-06	33-06	34-06	35-06	36-06	37-06
10x5x2Para30dg	24-07	25-07	26-07	27-07	28-07	29-07	30-07	50x10x1Trap45dg	31-07	32-07	33-07	34-07	35-07	36-07	37-07
10x5x2Para45dg	24-08	25-08	26-08	27-08	28-08	29-08	30-08	50x10x1Trap60dg	31-08	32-08	33-08	34-08	35-08	36-08	37-08
10x5x2Para60dg	24-09	25-09	26-09	27-09	28-09	29-09	30-09	50x10x2Trap45dg	31-09	32-09	33-09	34-09	35-09	36-09	37-09
12x5x1Para45dg	24-10	25-10	26-10	27-10	28-10	29-10	30-10	50x10x2Trap60dg	31-10	32-10	33-10	34-10	35-10	36-10	37-10
12x5x2Para45dg	24-11	25-11	26-11	27-11	28-11	29-11	30-11	50x10x3Trap45dg	31-11	32-11	33-11	34-11	35-11	36-11	37-11
25x10x2Para30dg	24-12	25-12	26-12	27-12	28-12	29-12	30-12	50x10x3Trap60dg	31-12	32-12	33-12	34-12	35-12	36-12	37-12
25x10x2Para45dg	24-13	25-13	26-13	27-13	28-13	29-13	30-13	50x20x1Trap30dg	31-13	32-13	33-13	34-13	35-13	36-13	37-13
25x10x2Para60dg	24-14	25-14	26-14	27-14	28-14	29-14	30-14	50x20x1Trap45dg	31-14	32-14	33-14	34-14	35-14	36-14	37-14
25x10x3Para30dg	24-15	25-15	26-15	27-15	28-15	29-15	30-15	50x20x1Trap60dg	31-15	32-15	33-15	34-15	35-15	36-15	37-15
25x10x3Para45dg	24-16	25-16	26-16	27-16	28-16	29-16	30-16	50x20x2Trap30dg	31-16	32-16	33-16	34-16	35-16	36-16	37-16
25x10x3Para60dg	24-17	25-17	26-17	27-17	28-17	29-17	30-17	50x20x2Trap45dg	31-17	32-17	33-17	34-17	35-17	36-17	37-17
25x20x2Para30dg	24-18	25-18	26-18	27-18	28-18	29-18	30-18	50x20x2Trap60dg	31-18	32-18	33-18	34-18	35-18	36-18	37-18
25x20x2Para45dg	24-19	25-19	26-19	27-19	28-19	29-19	30-19	50x20x3Trap45dg	31-19	32-19	33-19	34-19	35-19	36-19	37-19
25x20x2Para60dg	24-20	25-20	26-20	27-20	28-20	29-20	30-20	50x20x3Trap60dg	31-20	32-20	33-20	34-20	35-20	36-20	37-20
25x20x3Para30dg	24-21	25-21	26-21	27-21	28-21	29-21	30-21	56x10x1Trap30dg	31-21	32-21	33-21	34-21	35-21	36-21	37-21
25x20x3Para45dg	24-22	25-22	26-22	27-22	28-22	29-22	30-22	56x10x1Trap45dg	31-22	32-22	33-22	34-22	35-22	36-22	37-22
25x20x3Para60dg	24-23	25-23	26-23	27-23	28-23	29-23	30-23	56x10x1Trap60dg	31-23	32-23	33-23	34-23	35-23	36-23	37-23
50x5x2Para45dg	24-24	25-24	26-24	27-24	28-24	29-24	30-24	72x10x6Trap30dg	31-24	32-24	33-24	34-24	35-24	36-24	37-24
50x10x1Para30dg	24-25	25-25	26-25	27-25	28-25	29-25	30-25	72x10x6Trap45dg	31-25	32-25	33-25	34-25	35-25	36-25	37-25
50x10x1Para45dg	24-26	25-26	26-26	27-26	28-26	29-26	30-26	72x10x6Trap60dg	31-26	32-26	33-26	34-26	35-26	36-26	37-26
50x10x1Para60dg	24-27	25-27	26-27	27-27	28-27	29-27	30-27	80x10x1Trap30dg	31-27	32-27	33-27	34-27	35-27	36-27	37-27
50x10x2Para30dg	24-28	25-28	26-28	27-28	28-28	29-28	30-28	80x10x1Trap45dg	31-28	32-28	33-28	34-28	35-28	36-28	37-28
50x10x2Para45dg	24-29	25-29	26-29	27-29	28-29	29-29	30-29	80x10x1Trap60dg	31-29	32-29	33-29	34-29	35-29	36-29	37-29
50x10x2Para60dg	24-30	25-30	26-30	27-30	28-30	29-30	30-30	84x9x6Trap30dg	31-30	32-30	33-30	34-30	35-30	36-30	37-30
50x10x3Para30dg	24-31	25-31	26-31	27-31	28-31	29-31	30-31	84x9x6Trap45dg	31-31	32-31	33-31	34-31	35-31	36-31	37-31
50x10x3Para45dg	24-32	25-32	26-32	27-32	28-32	29-32	30-32	84x9x6Trap60dg	31-32	32-32	33-32	34-32	35-32	36-32	37-32
50x10x3Para60dg	24-33	25-33	26-33	27-33	28-33	29-33	30-33	<b>Rods</b>							
50x20x1Para30dg	24-34	25-34	26-34	27-34	28-34	29-34	30-34	38x3Ends45dg	38-01	39-01	40-01	41-01	42-01	43-01	44-01
50x20x1Para45dg	24-35	25-35	26-35	27-35	28-35	29-35	30-35	40x3Ends45dg	38-02	39-02	40-02	41-02	42-02	43-02	44-02
50x20x1Para60dg	24-36	25-36	26-36	27-36	28-36	29-36	30-36	50x3Ends45dg	38-03	39-03	40-03	41-03	42-03	43-03	44-03
50x20x2Para30dg	24-37	25-37	26-37	27-37	28-37	29-37	30-37	75x6Ends45dg	38-04	39-04	40-04	41-04	42-04	43-04	44-04
50x20x2Para45dg	24-38	25-38	26-38	27-38	28-38	29-38	30-38	83x6Ends45dg	38-05	39-05	40-05	41-05	42-05	43-05	44-05
50x20x2Para60dg	24-39	25-39	26-39	27-39	28-39	29-39	30-39	<b>ATR Repolishing</b>							
50x20x3Para30dg	24-40	25-40	26-40	27-40	28-40	29-40	30-40	30/45/60dg Para	xx-xxR	xx-xxR	xx-xxR	xx-xxR	xx-xxR	xx-xxR	xx-xxR
50x20x3Para45dg	24-41	25-41	26-41	27-41	28-41	29-41	30-41	30/45/60dg Trap	xx-xxR	xx-xxR	xx-xxR	xx-xxR	xx-xxR	xx-xxR	xx-xxR
50x20x3Para60dg	24-42	25-42	26-42	27-42	28-42	29-42	30-42	30/45/60dg Rod	xx-xxR	xx-xxR	xx-xxR	xx-xxR	xx-xxR	xx-xxR	xx-xxR

Tolerances: All dimensions +/-0.2mm. 5% discounting applies for an individual part number on order quantity 5 or more. Higher volume discounts available upon request.

Custom requirements are encouraged and available upon request; mechanical drawings with specifications and tolerances are prerequisite. REFLEX offers optical repolishing services, call for quotation and return procedure.

Repolished items are denoted by the item's new polished part number as identified within the above chart preceded by the letter "R". See above for standard repolished ATR element pricing.

Items are repolished on a best effort basis and the customer assumes risk associated with service. Skill and prudence is administered in every instance to ensure the best result. Rods are fabricated for Axiom and Spectra-Tech cells.

**GENUINE TOP PLATES** "performance guaranteed by the manufacturer"  
 NEW and RECONDITIONED assemblies...Contact Sampler, ARK\*, Baseline and GEMINI\*\* Series

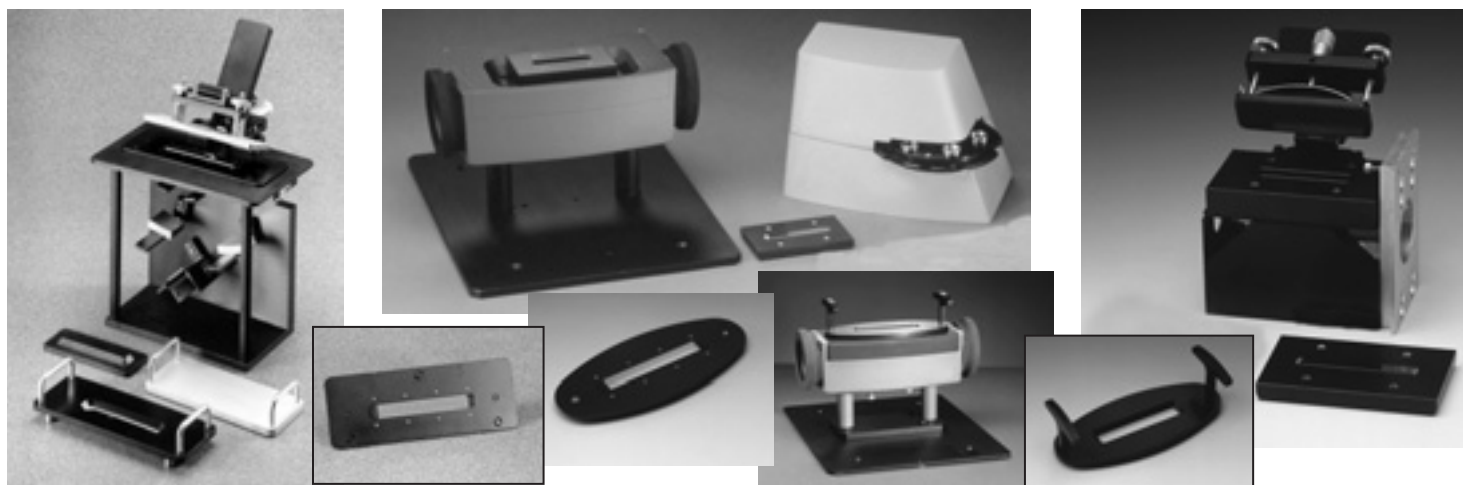

Flat Top Plate Assembly						
	Angle	ZnSe	Ge	ZnS	AMTIR	Si
Contact Sampler Part No. 0050- ARK Part No. 0055-	30°		714			
	45°	703	713	733		
	60°	705	715	735		

Trough Top Plate Assembly						
	Angle	ZnSe	Ge	ZnS	AMTIR	Si
Contact Sampler Part No. 0050- ARK Part No. 0055-	30°		614			
	45°	603	613	633	643	653
	60°	605	615	635	645	

Thermal Trough Top Plate Assembly (60°C max.)						
	Angle	ZnSe	Ge	ZnS	AMTIR	Si
Contact Sampler Part No. 0051- ARK Part No. 0055-	30°					
	45°	603		633	643	
	60°	605		635	645	

Thermal Trough Top Plate Assembly (100°C max.)						
	Angle	ZnSe	Ge	ZnS	AMTIR	Si
Contact Sampler Part No. 0051- ARK Part No. 0055-	30°					
	45°	653				
	60°	655				

Flow Cell Top Plate Assembly (non-heated version)						
	Angle	ZnSe	Ge	ZnS	AMTIR	Si
Contact Sampler Part No. 0051- ARK Part No. 0056-	30°		314			
	45°	303	313	333		
	60°	305	315	335		

Flow Cell Top Plate Assembly (200°C heated version)						
	Angle	ZnSe	Ge	ZnS	AMTIR	Si
Contact Sampler Part No. 0051- ARK Part No. 0056-	30°					
	45°	303H				
	60°	305H				

Flat Top Plate Assembly						
	Angle	ZnSe	Ge	ZnS	AMTIR	Si
Baseline GEMINI Part No. 0001-	45°	703	713			753

Trough Top Plate Assembly						
	Angle	ZnSe	Ge	ZnS	AMTIR	Si
Baseline GEMINI Part No. 0001-	45°	603	613			653

REPLACEMENT CRYSTALS Contact Sampler and ARK Series FLAT TOP PLATE AND FLOW CELLS						
	Angle	ZnSe	Ge	ZnS	AMTIR	Si
Crystal Only Part No. 7002-	45°	502	512			
Other angles are available upon request						

RECONDITIONED TOP PLATES Contact Sampler and ARK Series FLAT, TROUGH AND FLOW CELL TOP PLATE ASSEMBLIES						
	Angle	ZnSe	Ge	ZnS	AMTIR	Si
Contact Sampler ARK Part No. 7002-	45°	502R	512R			
Other angles are available upon request (includes top plate disassembly-reassembly and factory aligned replacement crystal)						



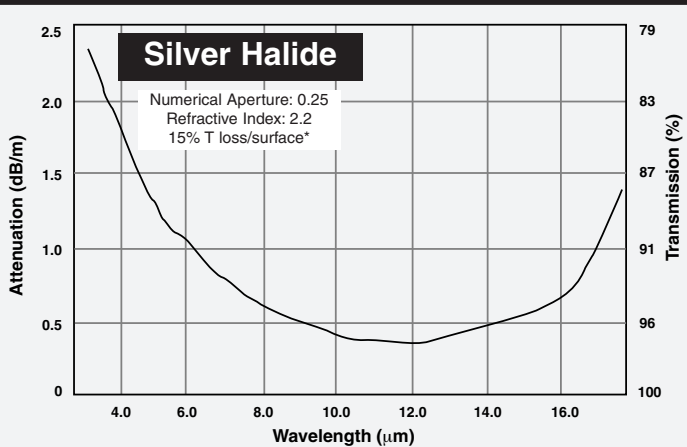
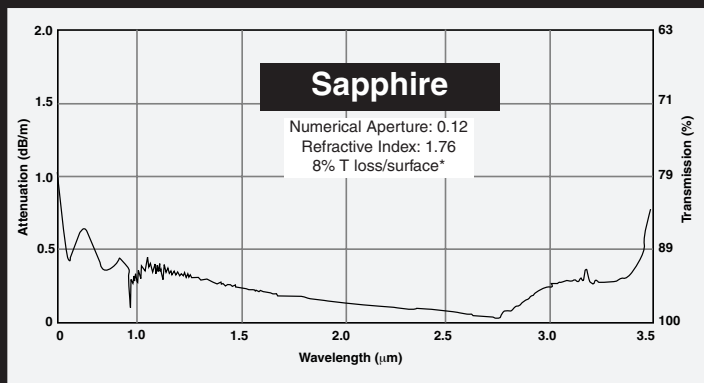
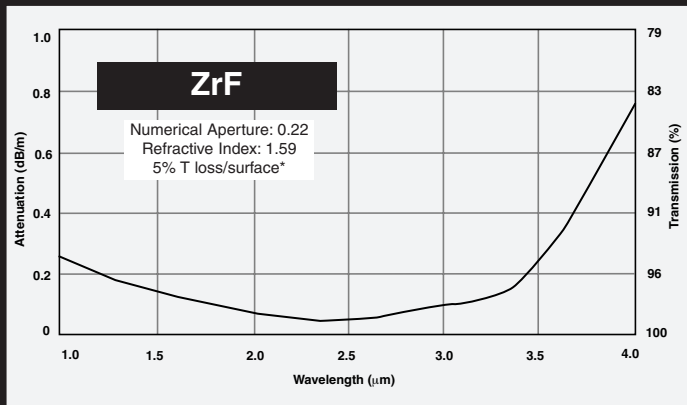
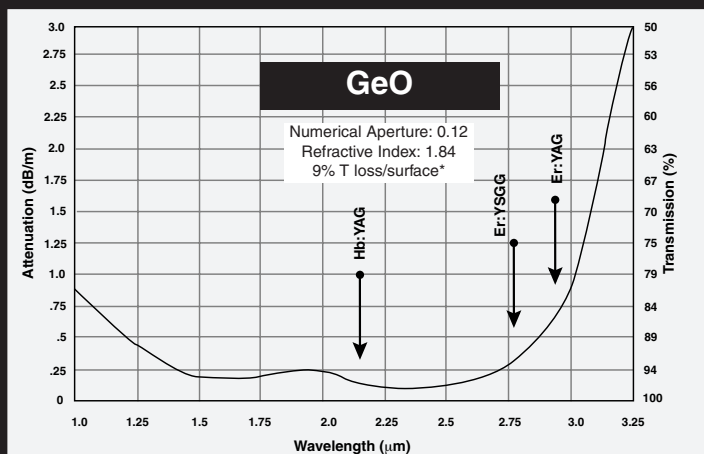
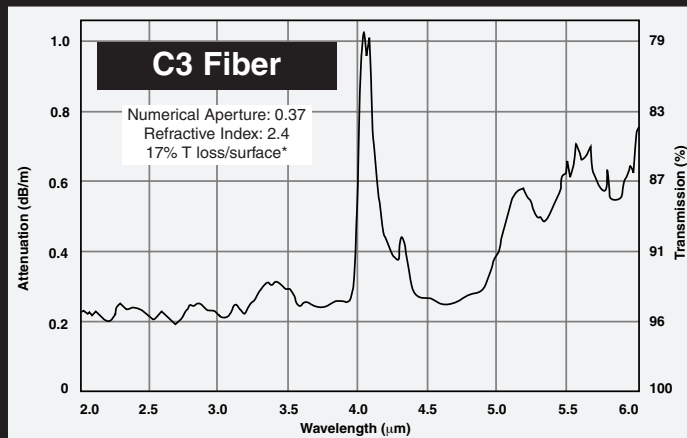
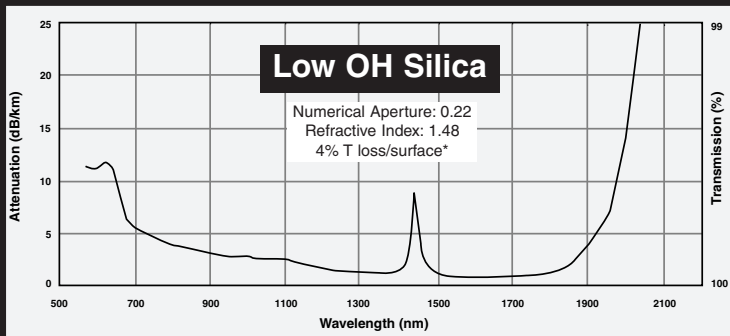
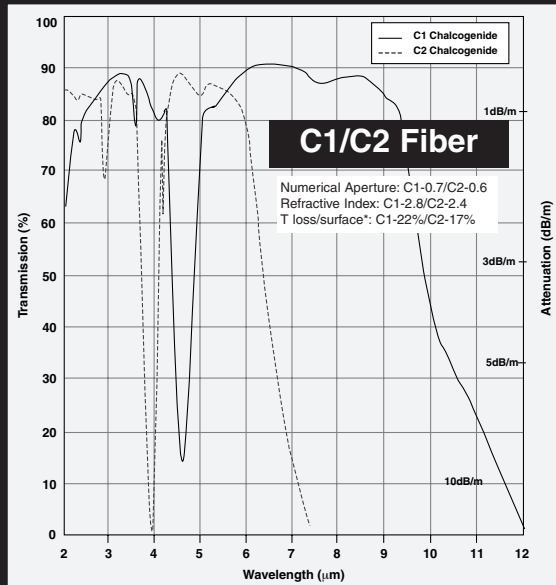
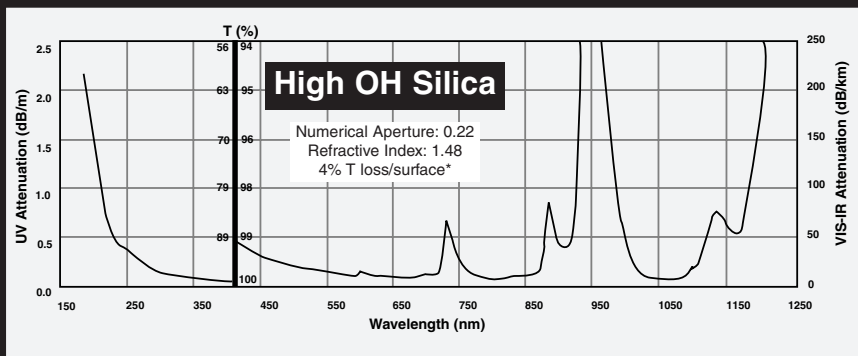

\*Flat and Trough Top Plates for the Contact Sampler and ARK will fit the REFLEX 2500 Series (see page 16)  
 \*\* Flat and Trough Top Plates for the Baseline and GEMINI will fit the REFLEX 9500 Series (see page 16)

# FIBER OPTICS



\* The attenuation and transmission curves on this page are representative and depict the internal transmission/losses within the fiber itself and does not take into account surface reflection loss at normal incidence.

\*\* Unit price per fiber length is dependent upon the fiber material, core diameter, length, terminations and sheathing. Contact REFLEX Analytical to discuss your requirement, advise specifications and request for quotation.

SENSOR	PART NO.	ALLOY	PATHLENGTH	FIBER	FIBER LENGTH	NOTES
 <p>Extreme High Pressure Fixed Pathlength Transmission Probe</p>	100H-X	Hastelloy	X=Pathlength Specify Pathlength 2mm 5mm 10mm	See Fiber Chart on page 20	Application Specified	A fixed pathlength, single pass design with proprietary Sapphire to metal seals. Spectral range 800-4500nm. Maximum temperature 400°C. Maximum Pressure 13000psi. Probe specifications: 27mm diameter x 32cm length with sapphire optics and SMA 905 female fiber connectors. Ideal for Near-IR measurements. Specify pathlength 2, 5 or 10mm. Applications include permanent side-stream or on-line analysis of liquid process streams. It may be dipped into liquid samples at the lab bench or inserted into reaction vessels. Stainless Steel assemblies available upon request.
 <p>Fiber Optic Interface</p>	200AA	Anodized Aluminum	N/A	See Fiber Chart on page 20	Application Specified	The Fiber Optic Interface links an FTIR spectrometer to fiber optic probes and sensors. The interface includes beam sending and return optics to provide for the efficient transfer of the infrared beam. It utilizes reflective and condensing features to optimize the wavelength region of the fiber optic accessory employed. SMA connectors allow for easy connection to the probe or sensor. A purge fitting is available for connection to source of dry air or nitrogen thereby minimizing the interference of water vapor and CO <sub>2</sub> normally associated with infrared measurements. Contact REFLEX Analytical to discuss your application.
 <p>High Pressure Fixed Pathlength Liquid Cell Gas Cell</p>	300SS-X	Stainless Steel	X=Pathlength Specify Pathlength 0.5mm 1mm 2mm 5mm 10mm 20mm 25mm	See Fiber Chart on page 20	Application Specified	Spectral range 800-4500nm. Maximum temperature 180°C. Maximum Pressure 500psi. Process connection provides 1/2" NPT thread. Sapphire collimating lenses are used for Near-IR and Extended Near-IR. Specify pathlength 0.5, 1, 2, 5, 10, 20 or 25mm. Applications include unattended side-stream or in-line process monitoring and laboratory sensing of liquids and gases.
 <p>Extreme High Pressure Diffuse Reflectance Contact Probe</p>	400H	Hastelloy	N/A	See Fiber Chart on page 20	Application Specified	Spectral range 350-2200nm. Proprietary Sapphire to metal seal. Maximum Pressure 5000psi. Maximum temperature 300°C. Probe specifications: 16mm diameter x 15cm immersible length, 6.4mm illuminated spot diameter and 6mm depth of field. Supplied with a 2 meter length, Near-IR bifurcated fiber bundle assembled with SMA-905 connectors. Applications include remote sampling of powders, emulsions, slurries or other scattering product.

High Temperature High Pressure Raman Probes

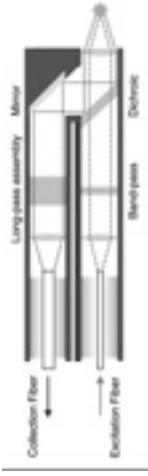

A method to remove fiber background from a Raman spectrum is optical filtering. Filters must be incorporated between the excitation and collecting fibers. The filters permit only the laser line to impinge upon the sample and also efficiently remove the Rayleigh line before the scattered light is transmitted through the collecting fiber. In conjunction with silica fiber optics, this proprietary design contributes to maximum transmission of a Raman excitation laser over many hundreds of meters. The 0.22 NA design consists of filters, permanently aligned micro-optics and two single fiber optic cables (90µm excitation, 200µm collection for the Standard Probe and 100µm excitation, 200µm collection for the Process Probe). The Standard Raman Probe spectral range is 200 - 3900 cm<sup>-1</sup> (Stokes). Maximum temperature 80°C. Probe specifications: 12.7mm diameter x 76mm length. Working distance 5mm (longer distance available). Assembled with 5 meter rugged polyurethane jacketed fiber cable with FC or SMA 905 connectors (up to 200 meters upon request). A laser emission indicator is an inherent safety feature. Applications include analysis through glass and plastic as well as measurement of neat solids and surfaces. The standard probe can be enhanced with fabrication from Hastelloy for 200°C and 1500psi physical ratings. Specify FT-Raman or Dispersive Raman instrumentation when discussing your application. The Process Raman Probe spectral range is 200 - 3900 cm<sup>-1</sup> (Stokes). Maximum temperature 500°C (external optics must be maintained below 200°C). Maximum pressure 3000 psi. Probe specifications: 19.5mm diameter x 240mm length. Factory set working distance (application specified). Assembled with 5 meter stainless steel jacketed fiber cable with FC or SMA 905 connectors (up to 100 meters upon request). A laser emission indicator is an inherent safety feature. Applications include reactor interface and process monitoring.

X=Wavelength  
Specify Excitation  
Wavelength  
514nm  
532nm  
632nm  
670nm  
785nm  
830nm  
1064nm

See Fiber Chart on page 20

Stainless Steel

REFLEX Analytical's series of laboratory presses are rugged and technologically advanced. They are designed to simplify the fabrication and automate the production of solid samples. The automated presses have a completely self-contained, electrically operated hydraulic power feature and assembly consists of rigid side slab construction. An integral safety shield with a clear, impact resistant access door surrounds the work area. For added safety, the door is interlocked with an emergency sensor which disengages press operation if the door is open. The unitized base permits convenient installation. Included is provision for vacuum line connection to evacuable pellet dies. The electronics provide for a microprocessor controlled system to program pressure, dwell time, rates of decompression and review of operational diagnostics. Operating parameters for the automated press series are easily programmed with keypad entry and digital display. The ram stroke automatically opens and closes with single button control.

The 40 and 50 Ton Auto Press Series features new technology to program parabolic bleed in addition to standard linear bleed capability. The sample particles progressively exhibit less tendencies to expand and develop fissures with the parabolic bleed function. This enables sample briquette formation at a higher pressure while maintaining the integrity of the sample surface. By controlling bleed time in combination with a selection of bleed type from linear or parabolic functions, bleed duration at each level is finitely adjustable. This constitutes a considerably large number of available combinations to eliminate or reduce fissure development while uniformly and reproducibly preparing samples. Operating parameters are easily programmed with keypad entry and digital display. The electronics provide for programming force, pressure, dwell time (0.1 minute increments), linear/parabolic bleed time (0.1 minute increments), sample size and sample identification (0 - 99). All sample parameters can be stored in database memory with user assigned codes and recalled to review operational diagnostics.

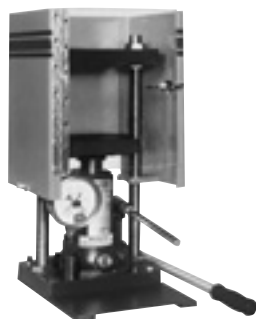

Part No. 3850



Part No. 3851



Part No. 3969



Part No. 25421



Part No. 3887

Part No.	Press Type	Force (tons)	Force (tons)	Programmable Dwell Time	Decomposition Rate	Heated Platens	Safety Shield	Platen Size	Ram Stroke	Daylight Opening (noted in inches)	Footprint (w x d)	Height	Weight (lbs)
3850	Manual	12	N/A	N/A	N/A	Optional	Yes	6x6	5.1	0.75-7	12x16	22	125*
4350L	Manual	12	N/A	N/A	N/A	N/A	Yes	4	5.1	0.75-7	10x8	20	115*
3851	Manual	12	N/A	N/A	N/A	Optional	Yes	6x6	5.1	0.75-18	15x16	36	200*
3968	Manual	12	N/A	N/A	N/A	N/A	Yes	10x7	5.1	1-16	17x18	37	345*
3969	Manual	12	N/A	N/A	N/A	N/A	Yes	12x12	5.1	1-15	21x28	37	560*
3853	Manual	25	N/A	N/A	N/A	Optional	Yes	9x9	6.5	0.75-16	19x24	42	350*
3855	Manual	25	N/A	N/A	N/A	N/A	Yes	12x12	6.5	1-14	21x28	37	600*
25011	Manual	25	N/A	N/A	N/A	Optional	Yes	3.5	1	0-6	12x7.5	25	106**
25401	Auto	8	0.5-8	N/A	N/A	Optional	Yes	3.5	1	1.5x6	17x16	25	209**
3888	Auto	15	0-15	0-999 sec. 0-99.9 min.	Linear Bleed 15, 45 or 120 sec.	Optional	Yes	6x6	6	0-15	35x20	40	400*
25421	Auto	25	3-25	N/A	N/A	Optional	Yes	3.5	1	1.5x6	17x16	25	209**
3890	Auto	25	0-25	0-999 sec. 0-99.9 min.	Linear Bleed 15, 45 or 120 sec.	Optional	Yes	9x9	6	0-12	37x20	43	600*
3887	Auto	25	0-25	0-999 sec. 0-99.9 min.	Linear Bleed 15, 45 or 120 sec.	N/A	Yes	5	1	1.5-7.25	32x23	22	400*
4387	Auto	40	0-40	0-999 sec. 0-99.9 min.	Linear Bleed 15, 45 or 120 sec.	N/A	Yes	5	1	1.5-7.25	34x23	26	500*
25601	Auto	40	4-40	0-5940 sec.	Linear Bleed	Optional	Yes	8	1.5	0-5.30	11x10	22	319**
43440	Auto	40	0-40	0-60 min.	Linear & Parabolic 0-60 min.	N/A	Yes	4	1.25	0-7.50	26x14	16	395**
43450	Auto ***	50	0-50	0-60 min.	Linear & Parabolic 0-60 min.	N/A	Yes	4	1.25	0-7.50	26x14	16	395**

\*CE Certification fee may apply for delivery destinations outside the United States.

\*\* CE Certified. No additional fee.

\*\*\*Auto Press Series, Heated Platens and Temperature Controllers rated 110V. Models rated 220V available upon request.

2095	Buffer Plate (90mm diameter) to center pellet dies for press part numbers 3850, 3851 and 3853
2096	Two Gauge Manifold. Permits low pressure operation (0 - 5 tons) with the use of press part numbers 3850, 3851, 3853, 3855, 3968 and 3969
2102.1	6" x 6" Steel Heating Platens, 110V with 65 - 260°C manual thermostat control for press part numbers 3850 and 3851
3796	6" x 6" Steel Heating Platens, 110V with 65 - 345°C digital thermostat control for press part numbers 3850 and 3851
2103.1	6" x 6" Steel Heating/Cooling Platens, 110V with 65 - 260°C manual thermostat control for press part numbers 3850 and 3851
3772	6" x 6" Steel Heating/Cooling Platens, 110V with 65 - 345°C digital thermostat control for press part numbers 3850 and 3851
2107.1	9" x 9" Steel Heating Platens, 110V with 65 - 260°C manual thermostat control for press part number 3853
3973	9" x 9" Steel Heating Platens, 110V with 65 - 345°C digital thermostat control for press part number 3853
2108.1	9" x 9" Steel Heating/Cooling Platens, 110V with 65 - 260°C manual thermostat control for press part number 3853
3972	9" x 9" Steel Heating/Cooling Platens, 110V with 65 - 345°C digital thermostat control for press part number 3853
15515	4" Diameter Water Cooled Heated Platens, 110V with 300°C digital temperature controller for press part numbers 25011, 25401, 25421 and 25601



Part No. 4350



Part No. 25011

**Press Specifications:**

 Dim. 20.50"H x 10.25"W x 8" D • Stroke 5.125"  
 Load 12 Ton • Daylight 7" max. • Net wt. 98lbs.

 Dim. 25"H x 12"W x 7.5" D • Stroke 1"  
 Load 25 Ton • Daylight 6" max. • Net wt. 106lbs.

- 4350L Mini "C" 2-Column Press with 4" Round Platen, gauge, buffer plate and safety shield
- 25011 Pre-set manually operated 0-25 Ton Press with 3.5" Round Platen, gauge and safety shield
- 2102.1 6" x 6" Steel Heating Platens 65 to 260°C
- 2103.1 6" x 6" Steel Heating/Cooling Platens 65 to 260°C with hoses

**EXTRA VALUE LABORATORY PACKAGE**

- 4350 Mini "C" 2-Column Press with 4" Round Platen, gauge, buffer plate, safety shield and 13mm evacuable pellet die
- 3850 Mini "C" 2-Column Press with 6" x 6" Platens, gauge and safety shield

**EVACUABLE PELLET DIES**

Evacuatable pellet dies are used to produce compact, durable powdered sample pellets or XRF briquettes. The dies are precision fabricated from high quality hardened stainless steel. Each die assembly includes a main body with a vacuum attachment, a base, O-rings (2), optically polished stainless steel pellets (2), a stainless steel plunger and a sample extractor cup to facilitate sample removal. Tungsten carbide pellets are optional for very hard or abrasive sample materials which may tend to mar

the surface of stainless steel pellets. Refer to page 22 for manual and automated presses featuring programmable linear and parabolic bleed functions. The XRF series of auto presses offer a large number of bleed combinations to eliminate or reduce fissure development commonly associated with sample briquetting and pellet formation. Custom sizes available upon request.

**Stainless Steel Evacuatable Pellet Dies and Spare Parts**

Die Size	Evacuatable Die Assembly	Pellet Holder with Mounting Plate	"O" Ring Kit	Spare set of SS Pellets (2)	Spare Extractor Ring	Plunger
3mm	3055	3395	3057	3056	3059	3058
5mm	3060	3400	3062	3061	3069	3063
6mm	3070	3401	3072	3071	3079	3073
8mm	3090	3403	3092	3091	3099	3093
10mm	3100	3404	3102	3101	3109	3103
13mm	3000	3410	3020	3010	3025	3030
16mm	3120	3450	3140	3130	3125	3150
20mm	3165	N/A	3167	3166	3192	3168
25mm	3170	N/A	3172	3180	3175	3178
32mm	3300	N/A	3320	3310	3325	3330
35mm	3350	N/A	3352	3380	3355	3360
40mm	3290	N/A	3292	3291	3297	3293
45mm	4047	N/A	4092	4065	4097	4093

**UNI-DIE**

A unique 13mm evacuatable pellet die that forms a pellet within the assembly's barrel after compressing the sample matrix between two polished mandrels using a laboratory press. The mandrels are "easily" removed while the pellet remains intact in the center of the barrel. The barrel is then placed in the path of the spectrophotometer's beam for analysis. The pellet can be dissolved with water and dried for subsequent sampling.



- 3000W 13mm Evacuatable Pellet Die, including barrel with vacuum lead, two polished mandrels with O-rings and slide holder
- 3010W Spare 13mm Polished Mandrels (2)



Part No. 15620

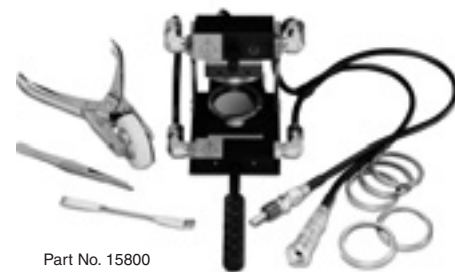

Part No. 15800

The **Constant Thickness Film Maker** prepares reproducible thickness polymer films and plastics. The high precision interchangeable spacer rings (15, 25, 50, 100, 250 and 500 micron) produce 29mm diameter films. The accessory provides an overflow trough for excess sample. Samples are easily removed from the polished die film fabricators without the use of contaminating release agents. A cooling chamber accompanies the 15620 Film Maker. The Film Maker is often used with a hydraulic laboratory press containing heating platens. The 15620 Film Maker can withstand maximum 4 ton load and 300°C while the 15800 Film Maker can withstand maximum 2 ton load and 400°C.

- 15620 Film Maker includes 15, 25, 50, 100, 250 and 500µm spacer rings, foil discs(200) and forceps
- 15800 Same as 15620 with integrated heating/cooling platens and temperature controller (specify 110V or 220V)
- 15627 Foil Discs (200/pk)

**HEATED PELLET DIES**

Heated pellet die assemblies are precision fabricated from high quality hardened stainless steel. The assembly includes a main body, an optically polished stainless steel pellet, a stainless steel plunger and a stainless steel sample extractor sleeve to facilitate sample removal. The dies can be heated up to 316°C maximum temperature. The manual temperature control is integrated on the main body for convenient regulation. Die sizes include 1.125" and 2.25" diameters. Custom

dimensions are available upon request. At 204°C the maximum applied load rating on the 1.125" die is 35,000 lbs and the 2.25" die is rated at 99,000 lbs. The overall dimensions for the 1.125" die are 3"h x 2.75"w x 3.75"d and 3.5"h x 4.25"w x 5"d for the 2.25" die. Each assembly includes a 3' long electrical cord.

- 2472 1.125" Heated Pellet Die (specify 110V or 220V)
- 2417 2.25" Heated Pellet Die (specify 110V or 220V)

**PELLET MOLD**

Pellet mold assemblies are ideal for fluid extraction, extrusion, flow testing and pressure forming. Standard die sizes include 1.125" and 2.25" diameters. Custom dimensions are available upon request. Each die is precision fabricated from high quality hardened stainless steel and robust to withstand a maximum applied load on the 1.125" die of 38,000 lbs and 102,000 lbs on the 2.25" die. The assembly includes a main body, an optically polished stainless steel pellet, a stainless steel plunger and a stainless steel sample extractor sleeve to facilitate sample removal. The assembly dimensions for the 1.125" die are 4"h x 2" o.d. and 4"h x 3" o.d. for the 2.25" die. Add 2" for the extractor sleeve to account for a 6" overall height. The standard die package includes 12 filters pads and a 5.50" stainless steel fluid pan.

- 2090 1.125" Stainless Steel Pellet Mold
- 2091 2.25" Stainless Steel Pellet Mold

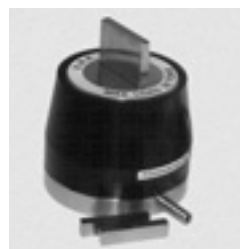
**SQUARE & RECTANGULAR PELLET DIES**

Evacuatable square and rectangular pellet die assemblies is another development in reply to requests offered by the IR and XRF spectroscopic community. The dies are precision fabricated from high quality hardened stainless steel. Each die assembly includes a main body with a vacuum attachment, a base, O-rings (2), optically polished stainless steel pellets (2), a stainless steel plunger and a sample extractor cup to facilitate sample removal. The maximum size is 40mm x 20mm

rectangular, 35mm x 35mm square although other sizes are available within these dimensions. Contact REFLEX Analytical with the die specification your application requires. Tungsten carbide pellets are optional for pressing very hard or abrasive sample materials which may tend to mar the surface of stainless steel pellets.

# GAS CELLS



This series of long path gas cells incorporates a three mirror design. The result is an incremental four pass multiple reflection system. The radiation from the source is focused in the entrance aperture, the diverging beam passes to the first objective mirror which then focuses an image on

the field mirror. The field mirror returns the beam to a second objective mirror that then directs the beam either out of the cell (4 passes) or back to the field mirror for extended pathlengths. The variable pathlength series offers an external pathlength set knob which allows the cell's pathlength to be adjusted. All cells feature corrosion resistant aluminum frames, three folding mirrors, KCl transmission windows, high throughput transfer optics, and two connecting vacuum valves as standard. A series of heated long path cells is also available for maximum temperature control up to 200°C. For cell alignment and visual verification of pathlength, a laser device is an optional component that can be integrated with most variable-pathlength cells offered by REFLEX Analytical. The laser is installed within a two-axis mount and affixed on the input side of the cell. As the red laser beam folds itself within the cell, the number of red spots appearing on the field mirror is indicative of the number of passes. The number of passes can then be translated to pathlength. A simple and convenient means to align, calibrate and verify long path gas cell performance. See the chart below for standard configurations. Refer to pages 12 and 13 for high temperature (up to 800°C) gas cells.

Part Number Unit Price	Cell Type	Pathlength (meters)	Cell Body	Inside Diameter (inches)	Base Path (inches)	Volume (liters)	Mirrors
MGC900	Permanent	.5	Glass	1.5	5	0.19	Gold
GPG-2414	Permanent	2.4	Glass	2	4	0.10	Gold
GPG-48256	Permanent	4.8	Glass	2.5	6	0.5	Gold
GPG-10412	Permanent	10	Glass	4	12	2.3	Gold
HGPG-10410	Heated Permanent <sup>1</sup>	10	Glass	4	10	2.3	Gold
GVG-6257	Variable	.6 - 7.2	Glass	2.5	7	0.5	Gold
GVG-16422	Variable	2 - 16	Glass	4	12	2.3	Gold
GVG-35524	Variable	4.4 - 35	Glass	5	24	8.5	Gold
GVG-107635	Variable	3.2 - 107	Glass	6	35	16	Gold
MGC920	Permanent	.5	Nickel Plated Alum.	1.5	5	0.19	Gold
MVG-838	Variable	.8 - 8	Anodized Aluminum	3	8	0.75	Gold

Part Number Unit Price	Cell Type	Pathlength (meters)	Cell Body	Inside Diameter (inches)	Base Path (inches)	Volume (liters)	Mirrors
MGV-10410	Variable	1 - 10	Anodized Aluminum	4	10	3	Gold
MGV-22522	Variable	2.2 - 22	Anodized Aluminum	5	22	8.5	Gold
MGC910	Heated Permanent <sup>1</sup>	.5	Nickel Plated Aluminum	1.5	5	0.19	Gold
HGPG-2824	Heated Permanent <sup>1</sup>	.4 - 2.4	Glass	2	4	0.10	Gold
HGVG-4310	Heated Variable <sup>1</sup>	1 - 4	Glass	3	10	1.3	Gold
HGVG-6438	Heated Variable <sup>1</sup>	.8 - 6.4	Glass	3	8	0.75	Gold
HMVG-6438	Heated Variable <sup>1</sup>	.8 - 6.4	Anodized Aluminum	3	8	0.75	Gold
HMVG-22522	Heated Variable <sup>1</sup>	2 - 22	Anodized Aluminum	5	22	8.5	Gold

All metal bodied cells are rated at 125psi.

<sup>1</sup> Requires Part No. 20100 all heated gas cells are rated to 200°C and require a temperature controller.



## TEFLON GAS CELL

The demountable 10cm teflon gas cell is a development in reply to requests offered by the IR spectroscopy community. The cell is fabricated from solid teflon bar stock thereby eliminating the risk of gases permeating and absorbing into the surfaces of normally coated or surface treated metal bodied cells. Gas analysts have confirmed the teflon body prevents degradation and cross contamination from residual gas sampling. The cell offers a 25mm clear aperture and volume capacity of 50ml. As pictured, assembly consists

of threaded 1/4" teflon valves, black anodized threaded aluminum end caps, viton "o" rings and teflon gaskets. A slide mount accompanies the cell which features a locking mechanism to align and secure the cell.

5900 10cm Teflon Gas Cell and Mount

Replacement Windows (sold as a pair)							
Cell Type	NaCl	KBr	CaF2	BaF2	ZnSe	ZnS	KRS-5
5900	5920	5921	5922	5923	5996		



5800WO Demountable 10cm Stainless Steel Gas Cell including cylindrical vessel with anodized aluminum threaded end caps, vacuum valves, Viton O-rings and teflon gaskets but without windows (see chart below for windows). Volume 120ml. Cell mount, Part No. 5030 required.

5025WO Demountable 10cm Pyrex Gas Cell including cylindrical body with anodized aluminum threaded end caps, stopcocks and neoprene gaskets but without windows (see chart below for windows). Volume 120ml. Cell mount, Part No. 5030 required.

5030 Cell Mount for 5800WO and 5025WO

5900SS Demountable 10cm Stainless Steel Gas Cell and Mount. Volume 50ml.

Replacement Windows (sold as a pair)							
Cell Type	NaCl	KBr	CaF2	BaF2	ZnSe	ZnS	KRS-5
5800WO, 5025WO	5020	5021	5022	5023	5096		
5900SS	5920	5921	5922	5923	5996		

## FTIR Spectra of Gases & Quantitative Software

This database consists of 254 digitized quantitative gas reference spectra. The spectra will permit the computation of concentrations from a sample spectrum without the need for any other calibration. An accompanying reference manual presents the spectra at 0.5 cm<sup>-1</sup> resolution while the digitized spectra can be displayed at resolutions of either 0.25 cm<sup>-1</sup>, 0.5 cm<sup>-1</sup>, 1.0 cm<sup>-1</sup> or 2.0 cm<sup>-1</sup>. A simple mouse click permits easy interchange between resolutions. The data incorporated with the spectra includes all quantitative parameters. These parameters may be changed to suit a particular analytical investigation. The principal quantitative method used with the software is the Region Integration and Subtraction (RIAS) program. RIAS is provided with the database and operates within a GRAMS software environment. RIAS automatically quantifies the extracted spectral details. Even complex mixtures of gases that have overlapping infrared spectra can be analyzed with parts-per-billion sensitivity. Each spectra of the measured compound can be easily removed from the sample spectra. The data system will continue to identify and measure as many compounds as are designated in the program. With RIAS, one can measure any compound that has an available digitized reference spectrum. The classical least squares method (CLS) is available for those desiring this technique. The program also allows the selection of integration regions and zeroing regions for complete removal of water absorption or other disturbing bands. Contact REFLEX for more information and to request the database index.

9255 Includes a database of 254 digitized gas reference spectra, reference manual and quantitative software program. GRAMS required.

9256 Gas Reference Spectra (254) Database only and reference manual.